

higher part of the section containing it, and at the other end to a lower part of the front or rear section A, F, as at D'. The front section A differs from the intermediate ones, having a door a^1 for

curved vanes B^1 into an annular chamber from which central jets are discharged into the room through the nozzles m and a diffused surrounding current through the perforated walls A. The

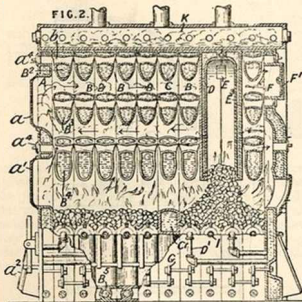

stoking, and other doors and covers a^2 , a , a^4 affording access to the ashpit and spaces between the channels for cleaning. The rear section F contains the opening F' for the exit of the products of combustion, which pass from the fire towards the rear F, then return between channels B^3 , B^1 , and finally pass between channels B^2 , B^3 to the outlet F'. The section C may be employed when both surface stoking and a reservoir supply of fuel are used; it differs from the sections B in having an additional horizontal channel C' to separate the two fires. The sections D, E are modified so that together they form a fuel reservoir, as shown, extending from the middle of the furnace upward to an opening in one side of it, closed by a door. An opening E' places the upper part of the reservoir in communication with the flue between the channels B^2 , B^3 when a damper is opened, the damper being governed by a handle in front of the lateral door so that it must be opened to allow escape of accumulated gas before the door can be opened.

1272. Hart, J. A. Jan. 20.

Heating air.—Relates to an apparatus for introducing fresh air into workshops &c. without producing draughts, and also for cooling, heating, or moistening the same when required. In one form of the apparatus, Fig. 7, a centrifugal fan B draws fresh air in through the pipe A and delivers it through its

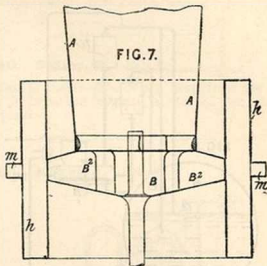
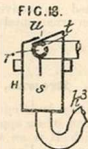

inductive action of the jets from m thus acts upon fresh air instead of producing currents in the polluted air of the rooms to be ventilated. The entering air may be cooled, heated, or moistened by helical pipes &c. placed in the passage A. Many modifications of this apparatus are described with baffle plates, and means for extracting and collecting excess moisture in the air. A valve or damper may be placed in the inlet duct of the apparatus and air from the apartment may be partly admitted with the fresh air for heating, cooling, &c. One form of moistening apparatus is shown in section in Fig. 18. Steam is discharged from the pipe r through perforations t into the trough H in connection with the pipes which discharge air into the room. The steam passes round the deflecting plate s and through the opening u into the air pipe, any water precipitated from the air being carried off by the pipe h^2 . In one form, a spraying nozzle is introduced into the inlet pipe to moisten the air. Several different arrangements of baffle plates with pipes for carrying off precipitated water are described. These precipitation arrangements are fixed in compartments surrounding the discharge apertures of centrifugal fan. The outer end of the inlet air pipe A may be covered with baffling apparatus in the form of tiers of caps.

1740. Messier, L. P. J. A. H. Jan. 26.

Steam traps.—Comprises apparatus for automatically controlling the delivery of feedwater to steam boilers and the discharge of water of condensation from steam traps. The action is made to depend on the difference in pressure at the upper end of a vertical tube communicating with the boiler or trap when filled with steam and when filled with water. Fig. 3 shows the apparatus as applied to the control of feedwater supply. A flexible diaphragm is mounted in a chamber B

which is connected on one side to a pipe opening at *a* into the steam space and on the other to a pipe *e* opening at the desired water level in the boiler *A*. The diaphragm chamber is situated

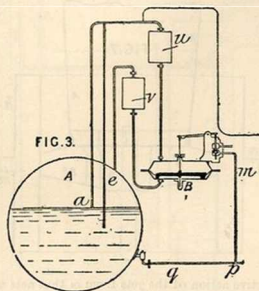

below the highest point in the vertical pipes, and the descending limbs of the latter are provided with reservoirs *u*, *v* in order that, owing to accumulation of water of condensation therein, there shall be a positive pressure on the diaphragm in one direction or the other according as the water level rises above or falls below the mouth of the pipe *a*. The movements of the diaphragm are, through suitable mechanism, made to actuate a valve controlling in an appropriate manner the feedwater supply through the pipe *p*, *q*, *m*. Various modifications in the construction and arrangement of this valve and the intermediate operating device are described. In the case of steam traps the movement of the diaphragm, when the water-level in the trap reaches a certain point, is utilized to operate a suitable discharge valve.

1770. Barter, W. R. Jan. 26.

Heating water.—Kitchens and other boilers are fitted with plates of soft or fusible metal which are arranged so as to burst, fuse, or to be perforated when the pressure in the boiler rises above its normal degree. In the arrangement shown a plate *d* of soft metal is clamped over an opening *a* in the boiler *a* and is enclosed by a casing *c* fitted with a lead-off pipe *f*. An adjustable screw *e* with a chisel point is arranged above the plate so as to perforate it if it bulges under pressure. Various other arrangements are described. The safety plates may be arranged over apertures in casings clamped to the boiler, from one to five of such plates being used, which may be constructed to burst under pressure, or to be perforated by fixed points. The escaping water &c. may be led away by pipes such as *f*, or can be directed on to the fire in order to extinguish it. In a modification, the plate is perforated but the perforation

is closed by a stud fixed inside the boiler and soldered to the plate. Increase of pressure tears the plate away from the stud and thus exposes the opening. In another arrangement the plate is

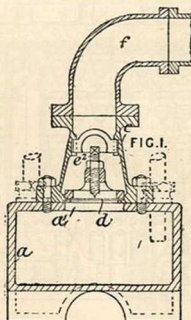

placed over the bottom of a tube extending downwards into the boiler &c. so as to bring it near to the part first heated. The plates may be made of fusible metal if desired.

1878. Appleby, C. J., [Defontaine, J.] Jan. 29.

Heating buildings &c.—Fig. 3 is a sectional plan of one of the sections of a radiator consisting of an inner tube *A* and an outer ribbed case *B* connected to similar sections by the flanged connections *E*. Water circulates in the space *C*, thereby heating the air which circulates through the open tubes *A* and thus promoting ventilation while the ribbed surface *D* radiates heat to the external air. The apparatus is mounted on convenient legs, and is provided with an ornamental cover for the top.

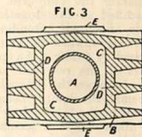

2072. Browne, E. L. Jan. 31.

Heating buildings &c.—Fig. 1 is a sectional elevation of an apparatus for heating greenhouses, in which *B* is an annular boiler with a separate fire-box *C* and an outlet pipe *P*. The hot air and gases from the fire grate *A* pass through the

central boiler tube thereby heating the water contained in the annulus, and are finally led away by the flue S, while the steam generated in the boiler

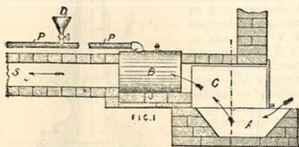

passes out by the pipe P to the conical distributors D, which latter have perforated plates to break up the jet of steam as it enters the greenhouse. In this manner the greenhouse is heated and the air moistened. Tobacco or other deodorizing agents may be introduced into the boiler to impregnate the issuing steam and thereby fumigate the greenhouse.

2498. Kohl, H. Feb. 5.

Boiling pans.—For heating by exhaust steam stationary liquids such as, for instance, sugar juice, the modification shown in Fig. 4 is used. The juice is carried in the jacket N having an enlarged mouth H while the steam descends the one passage of a double helix formed about the inner cylinder B and then ascends the second passage to the escape pipe e'.

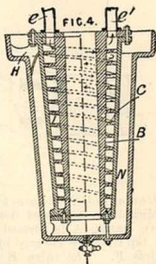

2501. Maritzen, H. Feb. 5.

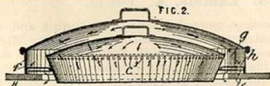

Boiling-pans.—The object is to prevent the emission of steam and gases from cooking vessels, boilers, &c. Fig. 2 shows a stewing pan. It is fitted with an exterior case or cover f resting on the top plate of the range. The steam escapes

from the pan through small perforations c and passes through openings h, i in the support g to the fire. Other vessels, as frying pans, steamers, &c., are similarly fitted, or, in certain cases, as in washing coppers, with central escape tubes.

2540. Fidler, E. Feb. 6.

Heating water.—The waste heat from gas and like hydrocarbon engines is utilized for heating purposes.

2588. Nagel, J. Feb. 6.

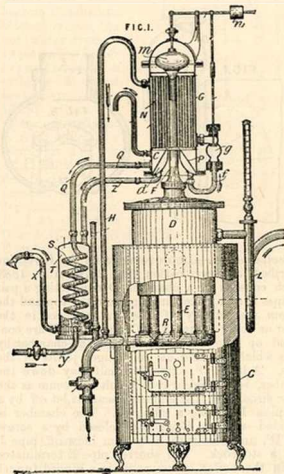

Heating water to sterilize it. The boiler is a hollow vessel D connected with a ring R and series of pipes E heated by a furnace C. A condenser and feed heater consists of a chamber G containing tubes N and traversed by the main steam pipe F from the still D. The lower part of the condenser is divided into two parts c, d by the conical partition P. The operation is as follows:—The steam raised in the still D passes up the pipe F, raises the balanced float valve m, is deflected downwards through the tubes N wherein it is condensed, and the water thus formed passes over the conical surface P through the pipe Q and coil S to the exit pipe X for distilled water. The feedwater passes

through the pipe *y* into the preliminary heater *T*, thence through the pipe *Z* into the chamber *d*, from which it flows through the pipe *f* into the main chamber *G* of the condenser, the rate of flow being regulated by the valve *g*, which is itself regulated by the valve *m* as shown, so that the rate of feed varies with the rate of distillation. The feedwater then passes through the pipe *H* into the still. The sterilized undistilled water in the boiler is drawn off through the pipe *L*. The counterweight *n* of the valve *m* may be varied so that the apparatus produces only distilled water or only sterilized water.

2600. Ross, A., and Wilford, S. J. Feb. 6.

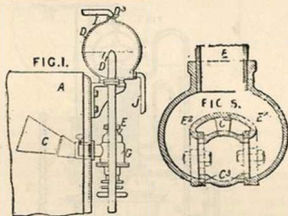

Heating water.—Improvements on the invention described in Specification No. 2074, A.D. 1883, which consists of a chamber *D* connecting a pair of pipes *E* and *F* leading up from the top and the bottom respectively of the water space in the boiler or other heater *A*. The pipes *E*, *F* are continued up into the upper half of the chamber by tubes which are held at the flanged joints of the pipes. A baffle *D'*, extending half way down the chamber, is formed in it to catch the scum as the water circulates; the collected scum is let off by a top pipe *I* having a stopcock. The chamber is provided with a filling-hole closed by a screw plug *D''*, and also with a bottom blow-off pipe *J* with a stopcock. The shorter pipe *E* terminates within the boiler or reservoir in a hinged funnel *C* floating at a constant depth in the water. The pipes are jointed to the boiler &c. by valve boxes *G* containing poppet-valves which may be screwed down, but are normally left free to close the outlets automatically in case the pipe or the chamber leaks. A hinged joint is made between the pipe *E*, which ends in a pair of branches *E'* curved so as to present their ends to each other, and the neck of the funnel, which has a trunnion-end *C* to turn in bearing-rings *C''* bolted to the ends of the branches.

2724. Dixon, J. Feb. 7.

Heating water.—A diaphragm *b* of mica &c. is clamped at *e* in nozzle *a*, and is ruptured when the pressure becomes too high. A pipe *d* connected to the nozzle by a union joint *e* conducts the escaping gas and steam to any suitable place for discharge. The diaphragm is made steam tight by a packer of lead, cardboard, &c.

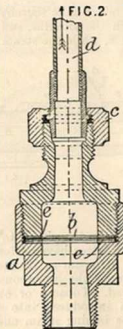

2994. Newsum, G. Feb. 12.

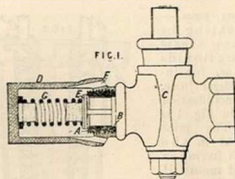

Heating water.—Relates to safety valves specially applicable to boilers of domestic fireplaces. The valve seating *A* is formed on an extension *B* of the tap *C*, and is covered by a cup *D* formed with outlets *F*. The valve *E* is held in place by a spring *G*, the pressure of which is determined by screwing up the cap. The tap *C* can be turned off when it is required to examine or repair the valve.

3075. Lambie, A. Feb. 13.

Heating water.—Means for securing and unfastening the manhole-doors of boilers. Fig. 6 represents a section of the modification most suitable for application to doors of small tanks, such for instance as bread tanks. Fig. 9 shows the application of the invention to tanks of large dimensions. Cam levers *c*, Fig. 6, mounted on pins *a*, on being partially rotated by the insertion in the slots *c'* of suitable levers secure, as shown at the right-hand of the Figure, the cover plate *A* to the shell *A'*. An end view of the fastening is shown

in the middle of the Figure. In Fig. 9 the eccentric cam *c* is shown as bearing upon bridges *a* over the manhole. Other methods of applying the eccentric cam to suit particular circumstances are described

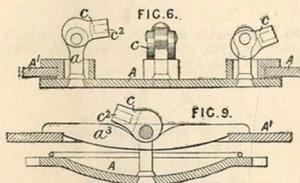

in the Specification and illustrated by drawings. In one of these arrangements the eccentric cam is provided with a pawl which, engaging with teeth of a ratchet, prevents the cam from shifting.

3171. **Culpan, G.** Feb. 14.

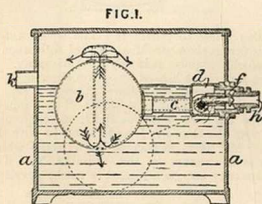

Steam traps.—The hollow float *b* contained within the casing *a* has a hollow trunnion joint *d* cut away so as to press the valve *f* upon its seating when in the horizontal position. The casing *a* is at first filled with water, causing the ball *b* to fill and sink so that condensed water is free to enter by the pipe *h*. As soon as steam begins to enter it finds its way along the pipe *c* and forces out the water contained in the float *b* through the outlets at top and bottom; the float thereupon rises and the steam is cut off. The action is repeated as soon as the ball fills, while the condensed water collecting in the cistern *b* escapes by the outlet *k*. An air outlet is provided in the trunnion joint to allow of air escaping when the ball is in the lowest position.

3223. **Donaldson, W.** Feb. 14.

Heating gases by electricity.—The gases are passed through a tube containing a coiled conductor through which a current is flowing; the section and resistance of the conductor are so arranged that the heating effect is least at the point of entry of the gases and gradually increases to the outlet, where the maximum temperature is attained.

3359. **Clay, H.** Feb. 16.

Heating water.—In order to prevent explosions in the boilers and water heaters attached to kitchen ranges, the hot water from a separate boiler circulates in a cylinder *M* and heats the water contained within the enclosing cylinder *L* from which the supply is drawn off. Both cylinders *L* and *M* are supplied from independent cisterns *K*, *J* by the pipes *C* and *B* respectively while the expansion pipes *E* and *G* prevent the pressure from rising to any great extent. Slightly modified arrangements are described and illustrated.

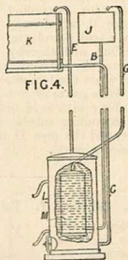

3465. **Russell, E.** Feb. 17.

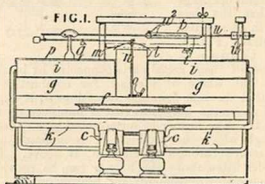

Thermostats.—Relates to the construction of a thermostat used in combination with a temperature alarm in an incubator. A flue *l* is arranged in the egg chamber, and is closed by a damper *m* operated by a lever *p* having an adjustable weight *q* and a rod *u* connected to the thermostat *o* consisting of a bent-pivoted tube filled with mercury.

3495. Churchward, G. J. Feb. 19.

Steam traps.—Relates to improvements in steam traps of the kind described in Specification No. 5267, A. D. 1893, and is intended for use with the steam heating coils of railway carriages, for steam engines, and the like. The condensed water and steam enters the apparatus by the pipe C, and heats by conduction the expanding substance B, which may be stearic acid, petroleum, or the like, and thereby compresses the india-rubber tube D, and closes the passage when the temperature becomes sufficiently high. Wire gauze or coils of wire may be inserted in suitable positions in order to communicate heat to the expanding substance and render its action quicker, and the pipe D may be strengthened by embedded wires E.

FIG. 2.

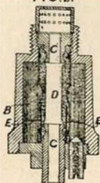

3630. Nixon, J. Feb. 20.

Heating water.—Relates to burners for burning gas, oil, vapour, &c., applicable for various heating purposes. The invention is mainly described with reference to a gas burner. The gas is admitted from below into the burner and escapes by lateral openings so that the jets burn in an annular trough E, F, Fig. 18.

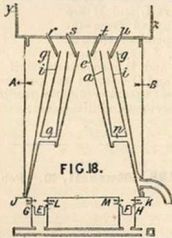

The trough is formed of sheet metal parts connected by brazing &c. The whole of the air for combustion is admitted through openings in casings J, K, L, M fitted above the burner so that it impinges on the gas jets. The burner is surmounted by a cylinder through which the products of combustion pass and escape through openings A, B above. The cylinder fitted above the burner can be provided with special arrangements for heating water. As shown in the Figure, water &c. is supplied from a cistern y, z, and passed by tubes r, s, t, u into the spaces enclosed by conical or equivalent partitions g, i and a, e. The water spaces are connected by transverse pipes o, u, or by V-shaped channels. When liquids such as tea, coffee, and cocoa are required to be heated, the spaces may be made separate, and are then provided with independent draw-off cocks. In order to increase the heating-surface the division plates are preferably embossed,

for instance, with a series of pyramids, the faces of which are similarly embossed, and so on, as far as practicable. The plates may also be formed with a matt surface by electrodeposition, roughening, &c.

3694. Dervaux, A. Feb. 20. [Date claimed under SEC. 103 of PATENTS &c. ACT, 1883, November 20th, 1893.]

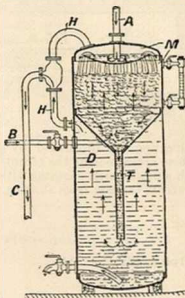

Heating water to purify it. The water enters the purifying chamber M at A and falls upon a plate which dissipates it in the form of spray. It is at the same time heated by steam entering by a pipe B, and, after passing down through a pipe T into a settling chamber D, is drawn off by a pipe C. This pipe has two branches H, H, one communicating with the chamber D and the other with the chamber M. It is connected to a pump which maintains a vacuum in the chamber M. The apparatus may also be arranged to act by gravity.

3687. Davidson, J. McK. Feb. 20.

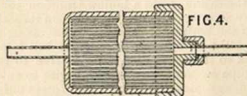

Heating air for circulation in hollow combs or brushes used for drying hair. A hollow cylinder with inlet and outlet tubes is filled with wire &c. to increase the heating surface. It is heated externally.

3963. Poole, G. W. Feb. 24. *Drawings to Specification.*

Heating buildings.—The products of combustion from a boiler furnace, after being led through a

smoke purifying apparatus, circulate through a heating system, and after passing through a second purifying apparatus are led back to the boiler furnace and there burnt.

3998. **Rach, C.** Feb. 24.

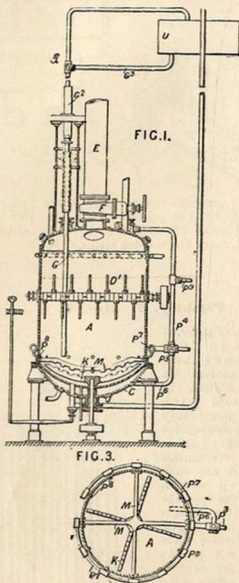

Boiling-pans for use in brewing. Fig. 1 is a vertical section and Fig. 3 a horizontal section of the apparatus, which consists of a cylindrical vessel A with a domed top and bottom, the latter of which has a steam jacket C. The vessel A contains horizontal stirrers M, K, and vertical stirrers O'. A pipe E with valve F communicates with the atmosphere, the pipes G, G', G'', allow of a circulation of the wort or beer between the vessels A and U, the latter of which may be a hop back or used for any other suitable purpose. A steam pipe P³ has a branch P⁴ leading to the top of the vessel A, a branch P⁵ leading to the jacket C and a circular ring P² having steam nozzles P⁶ through which steam can be passed directly into the charge. A pipe P⁷ allows of the introduction of compressed

filtered air into the apparatus when it is used for sterilizing. By closing the valve F the operations may be conducted under pressure. Suitable admission and discharge pipes are also provided.

4069. **Hamilton, O.** Feb. 26.

Heating liquids.
 —Relates to improvements in apparatus of the class described in Specification No. 11,249, A.D. 1892, for the purpose of heating liquids where deposits are likely to form, as in the process of dissolving litharge in ammonium acetate and the like. Within a wooden cylinder c containing the liquid to be heated are two rings pipes d connected by vertical pipes b. Steam enters the system by the pipe f and escapes by the pipe d after circulating through the piping and heating the surrounding liquid. With this arrangement there is a considerable scouring action of the liquid which prevents deposits forming on the heating coils.

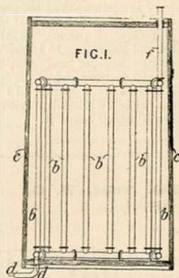

4074. **Bacon, A. J.** Feb. 26.

Heating buildings, air, &c.—Pipes are made with internal or external grooves or corrugations of any form for heating or cooling purposes.

4227. **Borden, T. P., and Lamplough, F.** Feb. 28.

Steam traps. — Fig. 1 shows one form. A casing 16 contains a flexible corrugated box 8 partly filled with a volatile liquid. The box is attached to the casing by an adjustable screw connection 9, and carries above an equilibrium piston valve 6 working in a casing 4 which is screwed into the casing 14 provided

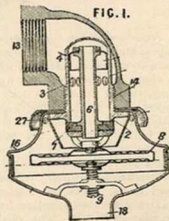

with an inlet 13. The condensed liquid and vapour enter by the inlet 13 and pass into the casing 4 by the orifices 3 and away into the casing 16 by means of the space between the valve 7 and its seating 2, finally passing away by the outlet 18. The hot liquid in its passage through the apparatus passes over the corrugated surface of the box 8 and expands it, thereby closing the valve 7 and stopping the flow of condensation liquid. Air entering by the orifices 27 quickly cools the box, and the valve 7 is again opened for the passage of the condensed liquid. The stem of the equilibrium valve 6 is hollow to permit the access of air to both sides, and the casing 16 is made in two parts fitting over one another and kept in place by pins in L-shaped recesses and a pin pressed into registering orifices by a spring. In a modified arrangement the box 8 is hemispherical and the equilibrium valve is placed below it.

4329. Todd, W. G., and Borchert, A.
March 1.

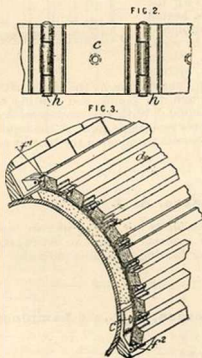

Non-conducting coverings.—For casing boilers, pipes, and the like, and to act as a protective surface to asbestos, felt, &c., where such is employed, a chain of the form shown in Figs. 2 and 3 is constructed in such a way as to carry strips of wood *d*, Fig. 3. Figs. 9 and 13 show clips for attachment to ordinary oval link chains *k*, the clips as before carrying the wooden strips. Fig. 14 shows another kind of clip by which the lower faces of the wooden strips are above the chains, which are of ordinary pattern. As regards Figs. 2 and 3 the links are formed from folded metal plates *c* secured together by hinge-pins *h* as shown in plan in Fig. 2. The chains may be secured to

brackets of the shape shown at *f*¹, *f*², or of other convenient form. With respect to the modification shown in Figs. 9 and 13, the flat portion of the

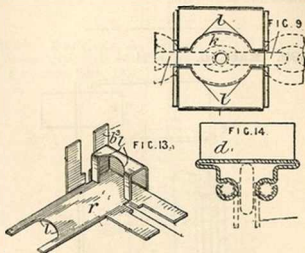

ordinary oval-link chain *k* lies in the bed *r* surrounded by the portions *l* of the link. The vertical arms *b*¹, enclosing the links which are vertical, carry the wooden strips.

4404. Pimbley, J. March 2.

Heating water.—Relates to fuel economizers and water heaters for steam boilers, in connection with which water may also be heated for warming rooms. The economizer pipes *A* are each formed with a transverse passage *B* along almost their whole length. This divides them into two parts which are so connected with the heads *D* from which the tubes are suspended as to serve for the descending and ascending branches of the water current. For cleaning purposes the end-covers are made removable. The scrapers *H* for cleaning the outsides of the tubes are worked by a rocking beam *R* oscillated by a crank. At the middle of the economizer a pair of water-heating cylinders traversed by tubes for exhaust or waste steam are arranged. The water thus heated may be used for heating rooms.

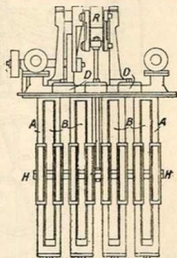

4415. Parker, W. March 2.

Heating water.—A vessel *a* with closed top *b* communicates with the boiler *A* and with a pipe *d*, *e* containing mercury *g*, the height of which is adjusted according to the pressure. The pipe *e* opens into or over a vessel *f* which receives the mercury in the event of it being forced out by excessive pressure. The screw plug *h* allows access to the vessel for cleaning.

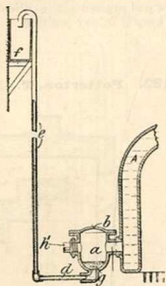
**4547. Burley, W.** March 3.

Steam traps.—A pair of perforated discs *b*¹, *b*² upon a spindle *b* are adapted to register with corresponding holes *a*¹ in the out-flow casing *a*. The valve is placed at the bottom of the steam trap casing and it is actuated by a float on the lever *b*¹ which is secured to the spindle *b*.

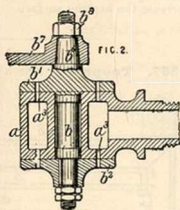
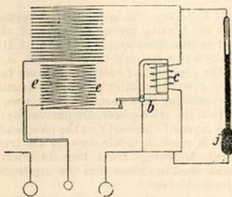
**4610. Moy, E. F.** March 5.

Thermostats for electric meters such as those described in Specifications Nos. 19,134 and 22,852.

A.D. 1891. A heating coil *e* is combined with a relay *c* and a thermometer *j*, with electrical contacts, in such a way that when the mercury rises sufficiently to complete the circuit through the thermometer, the relay armature *b* falls and the heating coil is cut out until the mercury falls.

4632. Kuhlwein, A. March 5.

Non conducting coverings and compositions.—Asbestos and asbestine are mixed with pulverulent substances such as gypsum, lime, chalk, fireclay, graphite, &c., and applied as a cement or moulded into slabs, plates, arch-stones, &c. To give increased strength wire netting, and sometimes also jute netting, is embedded in the composition. The composition is applicable in the construction of walls, ceilings, roofs, safes, strong-rooms, portable buildings, and for non-conducting coverings for boilers &c.

4975. Grinhaff, J. March 9. *Drawings to Specification.*

Heating liquids.—The liquids (*e.g.*, tea or coffee) for sale in a coin-freed delivery apparatus are kept warm in the storage vessel by a lamp, while a pipe leads from this vessel to the delivery vessel so as to keep the contents of the latter warm by steam.

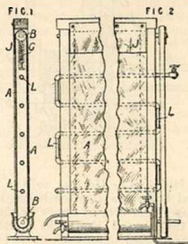
5086. Stott, J. March 10.

Heating air.—The air passes through a revolving screen *A* of open work fabric, which is kept moist by spraying liquid on to it, or, by causing its lower end to pass through a trough containing the liquid. The air may be heated before passing through the screen or during its passage by hot water pipes *L*.

5146. Brophy, M. M. March 12.

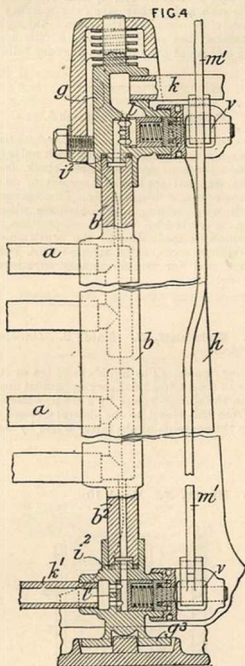

Heating buildings.—Heating coils *a* are fitted into pivoted boxes *b* supported below by a foot-step bearing *g* and carried above by the casting *g* pivoted in the frame *h*; the necks *b*¹ and *b*² of the boxes *b* are bedded upon packing *z* to allow of the pipes *a* being rotated out of their casing for cleaning purposes. The valves *l*, *l*¹ are of the hit and miss type and control the flow of fluid from the supply pipe *k* through the coils *a* and away by the outlet *k*¹, while they are pressed on to their seats by springs and turned by means of a claw coupling upon the operating shafts *v*, which latter are connected by an operating handle *m*¹. With the arrangement above described, the coils can be rotated without interfering with the regulating valves. The casing holding the coils is provided

with suitable doors for the inflow and outflow of the air, and the openings can be regulated by means of a pad pressed against the door by a spring so as to keep it in any position.

5182. Potterton, T. March 13.

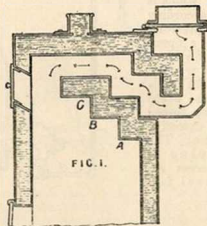

Heating water.—The escape flue of a boiler is made zig-zag in a series of steps *A*, *B*, *C*, &c. to increase the heating surface.

5367. Toope, C. March 14.

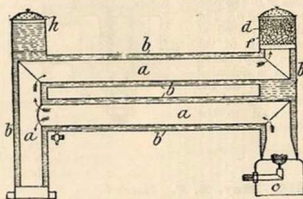

Heating buildings.—Relates to improvements in apparatus for heating greenhouses &c. of the class described in Specification No. 17,413, A.D. 1887. Within the water casing *b* there is a flue *a*, which conveys the products of combustion from the lamp or burner *c* to the outlet *d*, thereby heating the water surrounding the flue *a*. The hot gases, before escaping into the atmosphere, are purified by passing through a layer of charcoal *f* or the like; and if the apparatus is used in sick-rooms for the treatment of patients suffering from bronchial affections, steam is allowed to escape into the atmosphere by the perforated cover *h*.

5766. **Brown, C. J.** March 20.

Heating water.—Tubular surface apparatus, through which live or exhaust steam passes for heating water or steam, also applicable as a surface condenser, intermediate heater, and superheater. The arrangement is shown in vertical section in Fig. 2. The U tubes E, through which the steam passes, open out to the annular chamber I divided into two portions by suitable partitions, so that the steam entering by one aperture G traverses the tubes before escaping by the aperture H on the opposite side. The pocket N allows for the accumulation of the condensed steam. Cold water enters by a suitable mouth of the chamber A, which is capable of removal from the lower portion of the arrangement. The heated water passes away through the outlet C. By means of the detachable covers a^1 , a^2 the tubes are easily accessible for cleaning purposes. Sediment collects at the lower part M of the structure.

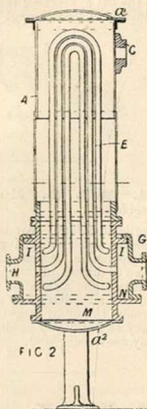

5882. **Mann, S.** March 21.

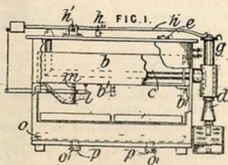

Thermostats.—Relates to the construction of incubators, and to means for regulating the temperature in the same. The hot water tank b of incubators such as described in Specification No. 13,786, A.D. 1893, is mounted on brackets b^1 , leaving an air space all round it for purposes of ventilation, which is controlled by a

valve e of any suitable construction. The incubator is heated by an exterior lamp d placed under a flue c , which is closed by a damper g operated by a lever h pivoted at h^1 , and actuated by a thermostat consisting of a cup l , in which is arranged a tube m of the shape shown, having one limb filled with ether and mercury. When the ether expands the mercury is driven into the other leg of the tube and causes the lever h to be operated. The water tray o is formed with tubes o^1 , projecting through tubes p in the bottom of the incubator. The bottom of the water tray is lined with moist flannel, through which the air passes, and is moistened before reaching the egg trays.

5898. **Fenlon, H. T.** March 24.

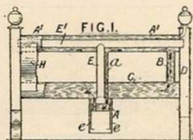

Heating buildings such as greenhouses. A gas burner is placed in the casing c under the boiler A . The heated water ascends through the pipe a into the horizontal tube A^1 , and from thence descends by the pipe B to the lower pipe C and then to the boiler. The products of combustion pass through the vertical flue E into the flue E^1 , and escape through the hollow standards D . The water circulation pipes are enclosed by curved metal plates H . When an oil lamp is used the flue E is arranged horizontally within the tube C , the hot gases then passing through it into one of the standards D , from thence traversing the flue E , and descending by the other standard. When the stove is provided with a base of cast iron the fumes may be finally led through inclined passages therein.

5977. **Dawson, J., and Lockwood, H.** March 22. [Grant of Patent opposed.]

Heating air.—In apparatus for drying wool and other animal fibre, particularly after treatment with acid to remove vegetable matter, the drying chamber is supplied with dried and heated air by means of a furnace A built against the wall B of the drying chamber and traversed by tubes F . The inner ends of the tubes open into the drying chamber, and the outer ends into a chamber or casing G , in the front part of which is a fan or air propeller H , which forces air through the heated tubes into the drying chamber.

(For Drawing see next page.)

5977.

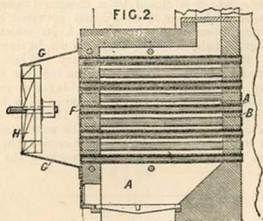

6023. Forster, W. March 22.

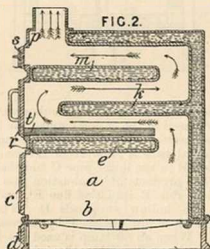

Heating water.—Saddle-boilers are provided with a number of transverse and longitudinal pockets or water-spaces *e, m* and *k* so arranged that they form a flue for the hot air and gases ascending from the furnace *b* to the outlet flue *p*, whereby the water circulating within the pockets is heated and a circulation is set up in the hot water pipes to which it is connected. To ensure good combustion open ended tubes *l* are placed above the pocket *e*, so that air is drawn into the flue by means of the ascending gases. Suitable doors *d, c, r* and *s* are provided for firing, cleaning the tubes, and regulating the draught.

6099. Justus, J. March 24.

Non-conducting coverings.—Fig. 6 shows the application to a pipe. The covering consists of a corrugated non-conducting plate *P* made of threads or "weaving" filled with a composition of

fossil meal, loam, clay, &c. Small points *b'* prevent the flat *b'* touching the pipe *a*, thus avoiding conduction of heat through the covering *P*.

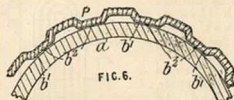

6154. Bell, R. March 27. *Drawings to Specification.*

Heating buildings.—Air is forced into a series of perforated shafts containing heating coils whereby its temperature becomes raised, and it is then allowed to diffuse into the apartment through perforations in the air shafts. In a modified arrangement, the air is heated by passing through a pipe externally heated by means of a furnace, while the air may be purified by passing through a dust guard of any convenient kind.

6168. Horne, W. March 27.

Heating buildings.—Box girders and columns are filled with water for the purpose of preventing and minimizing fires, and they may be connected by pipes *E* to ensure a complete circulation of the water. The columns and girders may be used for heating, drying, &c., or for supplying water for manufacturing or other purposes.

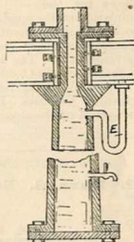

6230. Thompson, W. P., [Taylor, H. H., and Thrall, G.]. March 28.

Heating buildings.—An apparatus for assembling and connecting radiator loops is shown by Fig. 3 in side elevation, and by Fig. 4 in sectional elevation. Horizontal supports *A*, with vertical headstocks *A'* at one end, carry conical shoulders *a* for supporting the radiator loops *B, B'* at each end. The loops *B, B'* are connected together by nipples *C* screwed right and left handed and rotated by a hollow spindle *E'* provided with projections or a simple chucking device for holding the nipples firmly. The spindle *E'* is advanced by means of a pinion *e'* gearing with collars upon

the spindle, and the rotation is accomplished by means of gearing wheels E^1, f, F^2, G^2 driven from the shaft G^1 ; a suitable clutch G^3 throws the

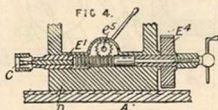
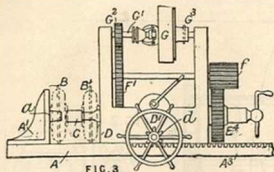

loose pulley G in and out of gear. The headstocks D for connecting each end of the radiator loops may be advanced along by the rack A^2 and pinion d driven by a hand wheel D^1 .

6436. Schöttelndreyer, L. March 30.

Heating water.—Geysers for the supply of hot water to shower baths. A steam jacketed casing A is traversed by a number of vertical tubes b , through which water flows, from the supply pipe i above, to the pipes d of the shower bath below, the water becoming heated in its passage through the casing A . The taps t having weighted levers m are controlled by means of cords r .

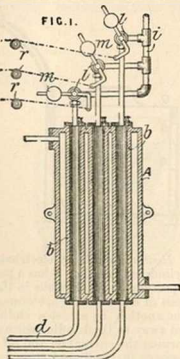

6440. Bray, G. March 31.

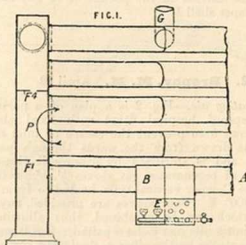

Heating buildings &c.—A perforated casing or "fire box" B formed in the lowest tube A of the system of pipes contains a battery of gas jets E . The hot products of combustion circulate in the directions shown by the arrows; they are prevented from ascending the upright pipes P by means of perforated diaphragms F^1, F^2 . The products of combustion, after circulating through the heating pipes A and P , finally escape by the outlet or flue G .

6565. Kirbis, E. April 2.

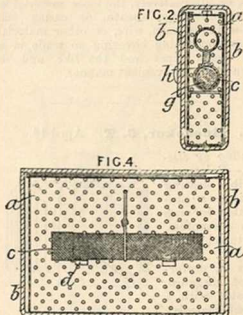

Hot water bottles and the like. Figs. 2 and 4 are a cross-section and longitudinal section respectively of the apparatus, which consists of a perforated tube C held by the transverse bearers d within a perforated casing a , which latter is

enclosed by a pocket *b* of cloth. The tube *C* contains a paper shell *h* fitted with specially prepared carbon *g*, which when ignited will glow for a considerable time without the access of air. The apparatus may be carried in the pocket or in any other convenient way, and is made ready for use by igniting the paper shell *h*.

7312. Brophy, M. M. April 12.

Heating air.—Fig. 2 is a plan of a portion of a fireproof hospital fitted with fixed air-tight windows *b* to prevent the escape or inlet of air. Air is drawn from the wards through passages *c*¹, *c*², and is sterilized by passing it through a series of regenerator gas stoves *b*¹, *b*², preferably of the Cowper vertical type, heated to from 1500° to 2000° F. Four stoves are provided, any three of which can be combined, thus allowing the remaining idle one to be repaired. Gas is supplied to the stoves by the pipes *e*, *e*¹, air for combustion by branch pipes *g*, *g*¹, and the air to be sterilized, after passing through two stoves, is carried off by flues *f*, *f*¹, and a chimney, blower, or the like. The passages and flues are provided with valves *j*, *j*¹, *k*, *i*, *i*¹, *i*², *i*³, *i*⁴, *i*⁵ to regulate the currents or supply of air and gas. Hot air can be supplied to the passages *e*¹, *e*² and hospital wards, for the purpose of purification, by pipes *h*², *h*³, *h*⁴.

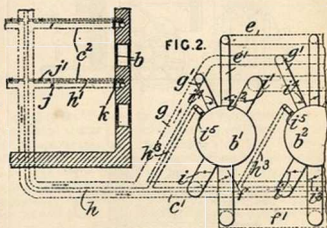

7385. Nelson, E. April 13.

Non conducting coverings and compositions.—Hair, asbestos fibre, silicate cotton, or other suitable material is formed into a rope by any suitable means, or, alternatively, the loose material is filled into an envelope, sheath, or casing made of asbestos, twine, yarn, wire, or other material, and the non-conducting covering so made is wound round steam pipes and the like, and secured thereon in any convenient manner.

7535. Snedekor, C. T. April 16.

Heating by electricity.—Relates to a flexible heating appliance also applicable for use as a compress, wrap, towel, bandage, &c. Conductors *b*, preferably of magnanin, are coated with a fireproof material, such as asbestos, a rubber or similar compound, and a waterproof tape, the whole being then enclosed in the material of the towel &c. *g* or between sheets of rubber which can be loosely placed in a bag of towelling. Switches *h* may be provided for altering the length of wire in the circuit.

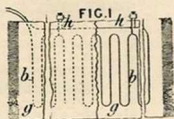

7933. Corin, W. April 21.

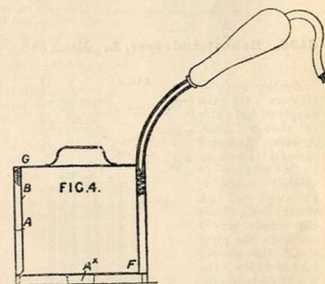

Heating liquids by electricity. A double-walled cylindrical vessel *A B* has a perforated base *F* and a perforated lid *G*, while in the annular space *A B* coils of covered wire are wound and insulated from one another by asbestos cloth; the terminals are led away to the handle, which contains a switch for turning the current on and off. The apparatus is inserted in the liquid it is required to heat, and there may be a strainer in the inner cylinder for holding tea, coffee, or cocoa, or the inner cylinder may be used for boiling eggs. The apparatus

stands upon legs $A \times$ so that the water or other liquid may easily circulate in and around the cylinder.

7978. Bruce, W. April 23.

Heating buildings.—Fig. 17 is a cross section of one form of the apparatus in which a casing C has a chamber A for lamps or burners. The circulation of the hot air and gases around the water tubes C causes a current of hot water to flow through these pipes and through the pipes B' in connection therewith. Air is admitted to the chamber by a cylindrical valve G , and is purified by a layer of filtering material H , and after becoming heated by contact with the pipes B it escapes from the outer casing J by the outlets M, M' into the room or apartment. The valve G has flexible edges of felt or the like for preventing leakage, and the pipe joints are of the spigot and faucet type staved with asbestos, or they may be of the butt and flange type. In modified arrangements there is a boiler with vertical flues for heating the water, and connected up to modified radiator sections also containing lamps and burners.

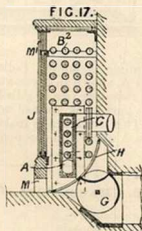

which are bolted to longitudinal runners 12 along the boiler. The tiles are further secured by a

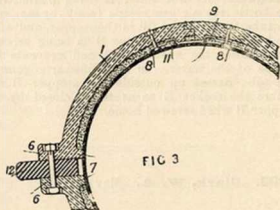

harness of longitudinal irons 8 connected by straps 9 having bends 11 which engage the terminal ridges 7 that give the space for packing between the boiler and tiles.

8752. Stutzer, A. May 2.

Digesters.—The cover a is made steam-tight on the hinge side by means of double hinges, each of which has a thumb-screw h in its leaf c to press the cover with a packing d against its seat.

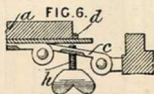

8261. Lean, H. April 26.

Boiling pans.—Relates to a copper or boiler for use in washing. The articles are steamed in the wire gauze receptacle A which is supported in the boiler B by the flange C , and terminates above in the sheet metal portion E .

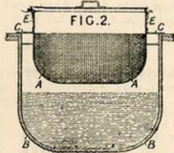

8817. Gray, C. H. May 3.

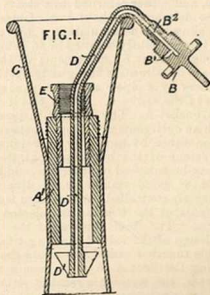

8637. Scott, W. A. May 1.

Non-conducting coverings.—Consists of quadrant tiles and intervening packing. The tiles 1 are rebated so as to overlap and underlap laterally, while the other ends are formed with feet 6

Hot water bottles.—The stopper B has fitted over the nipple extension B' a flexible tube D

extending below the bottle neck A¹ and furnished with a washer D¹ to prevent the tube from being withdrawn. As hot water is being poured into the bottle the air can escape freely by means of the tube D and outlet B¹ in the stopper, and after the bottle is filled the stopper B on being screwed down closes the aperture B¹ and prevents the escape of the water. In a modified arrangement, the tube passes up outside the stopper B but within the socket E so as to be closed by the stopper B when screwed home.

8902. Clark, W. A. May 4.

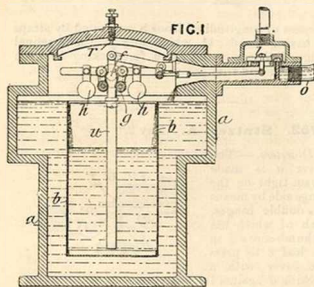

Steam traps.—By this apparatus water of condensation from steam pipes and the like is collected, and either returned to a steam boiler or otherwise delivered without loss of steam. The water is allowed to accumulate in a float or bucket which is intermittently emptied by an automatic action brought about by movements of the bucket itself due to the alternate filling and emptying. The water enters by a pipe *o* and after passing a valve *l* collects in the casing *a*. From this it overflows into the bucket *b*. The latter is suspended by a rod with an enlargement *f* nipped between rollers *g* acted on either by springs or by weights *h*. By the movement of the bucket or float, the valve *l*, which may be balanced or otherwise, and the entry of water of condensation or of live steam is approximately controlled. When steam is admitted, the contents of the buckets are ejected through the pipe *n*. The chief features of the invention are the design of the valve *l* enabling it to perform the double function named above, and the mode of suspending the float *b* so as to ensure a sudden action when the water has reached either one or other of two predetermined levels in the collecting chamber *a*. An automatic air-valve *r* may be employed, constructed as described in Specification No. 3063, A.D. 1890.

9027. Berry, G. L. May 7.

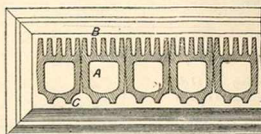

Heating buildings, radiators for. The water tubes A, shown in horizontal section, are provided with radiating ribs or gills B at the back only, the front part being formed with ornamental flutings C. This construction makes the moulding of the tubes A easier and cheapens their manufacture.

9033. Hausenblas, J. May 7.

Thermostats.—A cylinder C containing alcohol is closed by a membrane M. The expansion of the alcohol by heat causes the membrane to press the pivoted lever *h*, thereby closing the valve V, through which gas passes to a heating apparatus. The pivot *l* of the lever is adjustable by the screw *s*. The lever *h* is jointed, the two parts being kept in line by springs, this construction being designed to prevent damage to the apparatus from heat, such as that of summer, acting on the alcohol when the valve V is closed.

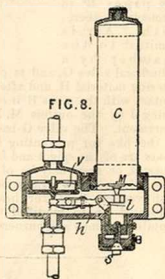

9104. Rausch, W. May 8.

Heating liquids.—A tube *g* containing hot water is immersed in the liquid, such as beer, whereby its temperature is raised and rendered more suitable for drinking purposes in cold weather. The tubes *g* are heated by means of a water bath provided with suitable apertures for hanging the tubes therein.

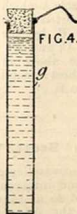

9205. Cannon, W. G. May 9.

Heating buildings

by air circulation. The invention relates to improvements in apparatus of the type described in Specifications No. 8395, A.D. 1884, No. 7131, A.D. 1885, and No. 7684, A.D. 1889.

Within a closed casing B are a number of coils 10 through which any suitable medium for heating may circulate. The air for heating and ventilating is admitted at the base of the casing by either of the apertures 15 and 17 and escapes by the outlet 18 in a heated condition into the room or apartment. In order to promote the efficiency of the coils, plates cut in sections are inserted between them to break up and distribute the currents of air passing through the casing.

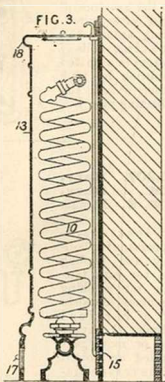

9404. Rogers, I. K. May 2.

Boiling pans,

saucepans, and other cooking utensils, are provided with a lid or cover constructed in two parts A, B pivoted together and formed with vent holes C and D respectively, which can be made to register. The vent holes in the upper part of the lid or cover are protected or shielded by the handle to prevent entrance of soot &c.

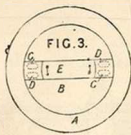

9516. Jones, F. M. H. May 15.

Non-conducting coverings.—Upon a sheet of asbestos cloth is placed a layer of silicate cotton attached thereto by means of asbestos thread or wire, the covering so made can be used for steam pipes and the like. Instead of asbestos cloth, other fabrics may be used, rendered incombustible in any well known manner.

9646. Robinson, E. May 17. *Drawings to Specification.*

Heating air.—In an apparatus for drying coffee, cocoa, spice, &c., an air-heating apparatus is employed, consisting of a stove and a suitable arrangement of flues. The stove and a portion of the flues are provided with a water jacket, and the whole is surrounded by a casing, through which the air to be heated is drawn or forced. Within the casing spiral surfaces may be fitted for retaining the air for a longer time in contact with the heating pipes.

9698. Fell, J. C., [Stewart Manufacturing Co.]. May 17.

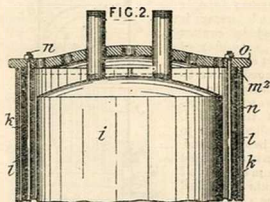

Non-conducting coverings for boilers.—Consists of a pair of metallic shells *k, l*, with an intermediate lining of asbestos, set inside and outside of a flange *m^2* on a cover *o* and a corresponding flange on a ring at the bottom, which is connected to the cover by long bolts *n*.

9615. Laurent, P. M. F. May 19. [Date claimed under SEC. 103 of PATENTS &c. ACT, 1883, November 20th, 1893.]

Heating water &c.—Plates to apparatus for enabling two or more fluids to exchange their temperatures, specially intended for sterilizing liquids, but applicable also for heating, cooling, condensing, distilling, and other similar purposes. It consists essentially of two or more spirally coiled sheets of metal, between

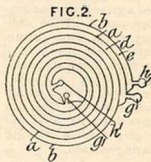

which the fluids are caused to circulate in opposite directions. In the form shown in the Figure, two metal sheets *a* and *b*, separated by distance pieces, are coiled round a central tube so as to form two

spiral passages *d* and *e*. One liquid enters the passage *d* by the pipe *g* and leaves by the pipe *g*¹, while the other enters the passage *e* by the pipe *h*¹ and leaves by the pipe *h*. When employed for sterilizing liquids, the two passages communicate with one another at their inner ends and the central tube is heated internally. When a longer surface is required, two such pieces of apparatus may be combined together, one being heated internally and the other not. The liquid to be treated enters and leaves the latter.

tubes. The water enters the boiler by the aperture *a*² and after circulating around the heating coils *j* escapes in a heated condition by the outlet *a*³ of the collecting pipe B.

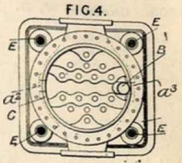

10,118. Wright, H. T. May 24.

Heating water.—Relates to water heaters of the Berryman type, in which water is heated by contact with a number of heated tubes arranged in a vertical casing. In the present arrangement the shell C is bolted down to the base A, and counterweighted by means of weights attached to the chains passing over pulleys arranged at the summits of the pillars E, so that the shell C can be easily lifted clear of the heating

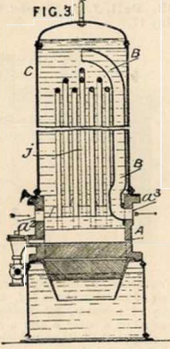

10,207. Bury, M., and Bury, W. T. May 28.

Digesters.—Apparatus for boiling and feeding size for yarn tapping or slashing machines consists of a vertical cylinder C having one or more perforated or slotted transverse diaphragms. The steam and size are supplied by pipes D, E respectively, and the boiled size passes by the pipe G to the "sow" or starch-box B of the machine.

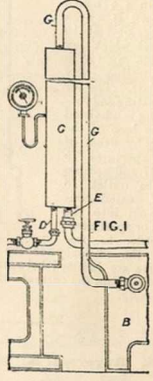

10,310. Rippingille, E., and Brandon, W. May 28.

Heating buildings.—A lamp stove *c* is connected to the air or water tubes *d* of a greenhouse heating-apparatus A in the ordinary way, and immediately over the tubes *d* are angle bars *g* supported by lugs *f*¹ on the stands *f* for carrying propagating-frames and the like; the tubes *d* are flattened out to give a more effective heating-surface.

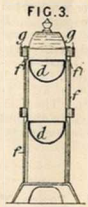
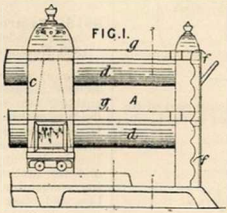

10,464. Saur, W. May 30. *Drawings to Specification.*

Heating water.—The setting of a steam boiler furnace, and of the externally-fired boiler to which the furnace is attached, is formed of a water-jacket from which a supply of hot water is drawn for the purposes for which it is required as, for instance, for use in laundries and factories.

10,518. Christy, T., and Christy, L. F.
May 30.

Heating by electricity.—Relates to means for electrically heating the rolls employed in ironing or glazing machines, or for paper calendering, &c., also applicable to heating other articles such as plates for baking &c. The Figure shows the application to a roll. The electric wire *d* of high resistance preferably of iron is wound upon the porcelain tube *b*, and is covered with some suitable insulating cement. The terminals *f* are embedded in the plaster core *e*. The wire *d*, protected by the insulating cement, is surrounded by a coating of zinc *g* to prevent oxidation of the wire and to uniformly disseminate the heat. Electric connection is made by means of a metal brush and the pulleys *m*.

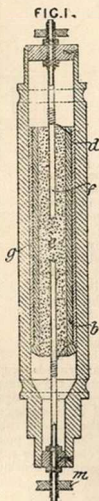

10,553. Green, J. G., and Blum, J.
May 31.

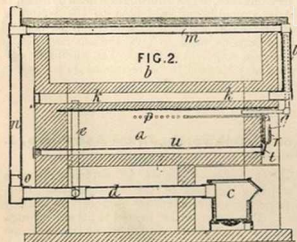

Thermostats.—Relates to means for regulating the temperature in the incubating chamber of a

combined incubator and fostermother heated by flues from a stove *c*. A coil of pipes *p* is arranged in the incubating chamber *a*. The said coil is closed at one end, and at the other end is connected to a U-tube *g* filled with mercury, upon which rests a float *r* connected to a door *t* for the inlet of cold air when the temperature rises too high, as indicated by the expansion of the air in the pipe *p*.

10,676. Wailes, E. F. June 1.

Non-conducting compositions.—A mixture of bitumen, lime, cement, resin, and asbestos fibre, in certain proportions, is thoroughly incorporated by boiling. The surface to be coated is first cleaned with a solution of bitumen, and the non-conducting mixture is afterwards applied in a paste to about the depth of half an inch, sheets of asbestos or other like material are then laid upon the top, and another coat of composition is applied, and so on until the required thickness is obtained.

10,837. Davis, O. C. June 4.

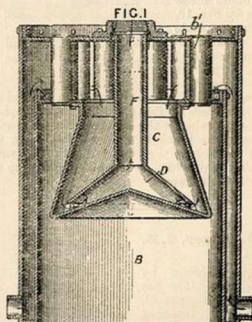

Heating water, boilers for. The vertical boiler, Fig. 1, is provided with the depending water chamber *C* which contains the deflector *D* and ascending tube *F*. Combustion products ascend through smoke tubes *b'*.

11,226. Morison, D. B. June 9.

Heating water.—The invention relates to improvements in apparatus of the type described in Specification No. 9548, A.D. 1893. Figs. 3 and 4 are a side elevation and a cross section respectively of one form of the apparatus, consisting of a casing 2 containing below two sets of removable coils 4

supported upon trunnion hinges 7, while above these is another set of coils 4^a similar in every respect. Steam or hot water can be circulated through these coils in order to heat or evaporate the water

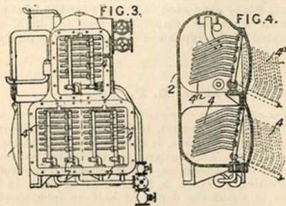

contained within the casing, and, the coils can be used altogether or independently. A longitudinal section of the trunnion hinge is shown by Fig. 13, in which a movable cap or socket 12^b fixed to the coil carrying tube 10^b swivels upon the fixed plug *k* with a screwed extension 11^a and cap 11^b. The orifices of the plug and socket register when the coil is inside the casing so that the heating fluid may pass through the coil, but when the coils are pulled over the supply is cut off; a small orifice may be provided in the plug for testing the coils while under repair.

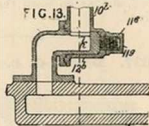

11,370. Alger, C. E.
June 12.

Heating buildings by air circulation. The hot water or steam pipes A¹, A², A³, A⁴ touching externally the sheet iron casing B heats the air passing from outside into the building through the casing. In modified arrangements, the pipes are placed inside the casing and several of these casings may be arranged in suitable positions in the building and the air supply regulated by flap valves or the like.

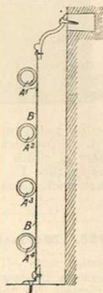

11,525. Fletcher, G. June 13.

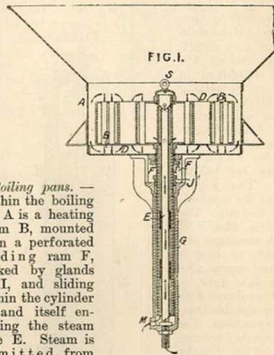

Boiling pans.

Within the boiling pan A is a heating drum B, mounted upon a perforated sliding ram F, packed by glands J, I, and sliding within the cylinder G, and itself enclosing the steam pipe E. Steam is admitted from below, and circulates within the drum B, afterwards escaping through the annular space between the steam pipe E and ram F to the outlet M, while the sugar or liquid contained in the vessel A circulates around the drum B and through the various tubes D, thereby becoming heated to the boiling point. The drum B can be raised for cleaning or other purposes by means of the eye S without breaking joint.

11,560. Peters, C. A. June 14.

Non-conducting compositions.—A mixture is made of from 85 to 90 parts of kieselguhr with from 15 to 10 parts of calcium oxide, cement, or the like, and the dry mixture, when thoroughly incorporated, is filled into moulds and subjected to the action of steam and water at high pressure. Wire netting or fibre may be used to give the non-conducting composition sufficient stiffness. The moulded composition may be used for covering steam pipes and the like.

11,603. Ashworth, J., and Ashworth, J.
June 14.

Heating water.—Consists in surface-apparatus for utilizing the heat of the exhaust steam from low-pressure and condensing engines for heating water. The water to be heated is passed through a chamber, through or around which the exhaust steam passes on its way to the condenser. Figs. 7 and 8 are sections at right angles to each other of one of the several forms of the apparatus illustrated

in the Specification. The steam passes through the chamber C, traversed by tubes C', and surrounded by the water-chamber B.

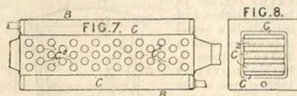

11,661. Buchanan, A. E., and Raleigh, H. June 15.

Heating by electricity.—An electric current, generated by a battery, dynamo, or the like, is sent through a wire which passes through the pipes, tanks, meters, and other water or liquid supplying apparatus, and the heating of the wire prevents the liquid freezing. The apparatus may be made self regulating by means of a thermostat.

11,927. Jackson, H. June 20.

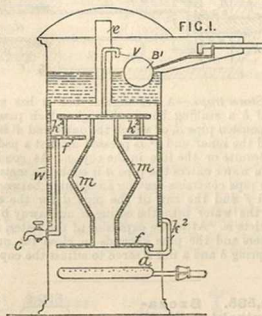

Heating water, geysers for. Cold water is admitted to the upper part of the casing by the ball-tap B', and is received into the annular space W, from whence it is led by the pipe l^2 into the double cone m and hollow plates f, around which the hot air and gases from the burner a are circulating before escaping by the chimney e. The hot water is drawn off by the tap C, and any steam formed in the annulus m is discharged by the pipe V.

11,945. Harker, W. June 20.

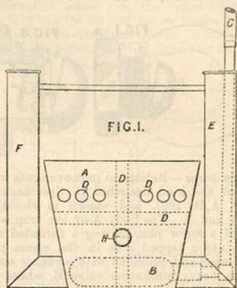

Heating water, portable apparatus for. A vessel A, of any convenient form, contains a gas burner B supplied by the pipe C, and is furnished with an air inlet pipe E and a fume escape pipe F. The burner B is lighted through the pipe H, and the apparatus is placed in the bath or other receptacle containing the water, which latter circulates through the water tubes D and thereby becomes heated. In a modified apparatus, there are two burners, each provided with inlet and outlet pipes.

12,206. Bennett, J. E. June 23.

Heating liquids.—A number of corrugated tubes a are connected at their end to chests b, c and through the tubes a are passed internal pipes d so that the heating or refrigerating agent from the chests b and c passes through the annulus between the pipes a and d, thereby exposing a great amount of surface. The tubes a are placed in the liquid to be heated or cooled, and the agent is forced through the annular space e in any well known manner.

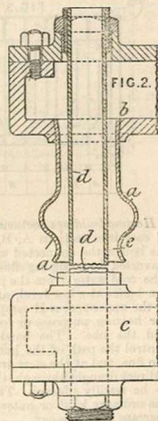

12,215. Gold, E. E. June 23.

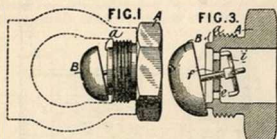

Steam traps.—Relates to improvements in steam traps of the kind described in Specification No. 17,139, A.D. 1891, and shown in elevation by Figs. 1 and 3. The body A of the trap is in the form of a screw plug having a threaded neck to screw into a tapped hole in the steam pipe or other vessel and provided with an inner seating *a* for the heavy mushroom valve B, whose stem *f* passes through the perforated grating *e* and is secured to a metal cross with upturned flanges *i*, all so constructed that the valve has a constant tendency to fall away from its seat. With this arrangement the valve is pressed upon its seat while the steam pressure is sufficient, but falls away when the pressure is reduced to allow of the escape of water of condensation. Slightly modified arrangements are described and illustrated.

12,356. Toulmin, C. T. June 26.

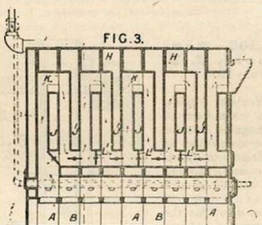

Heating buildings, sectional boiler for. A number of cast iron sections A, B, bolted together, form the boiler, the connected water spaces J, J' being traversed by a zig-zag flue K from the firegrate. The cold water from the pipe system is fed into the boiler at a low level, and the steam collecting in the upper spaces H escapes into the pipe system for heating purposes or for use in steam engines and the like. The hand-actuated dampers L control the path of the hot air and gases through the flue, and at the start are placed so that there is a direct draught through, thereby enabling a start to be readily effected. The firegrate may be of the ordinary kind, or water firebars may be used to increase the efficiency.

12,414. Berriman, W. June 26.

Boiling pans.—Relates to apparatus for use in boiling clothes, and consists in a vessel *a* provided with a false bottom *b*, having upright tubes *d* open at the top. The pressure of the steam beneath the concave false bottom *b*, forces the heated water up to the pipes *d* to be discharged over the clothes. When the pressure of the water in the vessel *a* is sufficiently great, it opens suitable valves and some of the water passes down beneath the false bottom *b*. The vessel *a* exactly fits over the stove *g* so that smoke &c. can only escape up the flue.

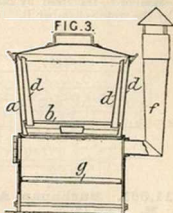

12,513. Jeffery, W. June 28.

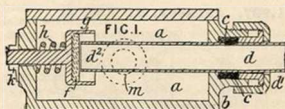

Steam traps.—A rectangular box *a* has at one end *b* a stuffing box *c*, through which passes an expansion pipe *d*, of which the outer end *d'* is fixed and the inner end *d''* is pressed against a pad *f* of vulcanite or the like in the cup *g*. As condensation water enters the pipe *d* it cools the metal, and the pipe contracts leaving an opening between the pad *f* and the end of the pipe *d* for the escape of the water into the casing *a* and away by the outlets *m*. After the expulsion of the water, steam enters and the pipe expands to close the outlet; a spring *h* and a nut *k* serve to adjust the cup *g*.

12,585. Szczawinski, S. M. B. von. June 28.

Heat-storing apparatus.—The object to be kept warm is placed in a space surrounded by a salt or compound fusible at a suitable temperature. The latent heat assists in maintaining the heat. Fig. 2 is a section of a suitable apparatus. A is, say, a bottle of milk to be kept warm. The

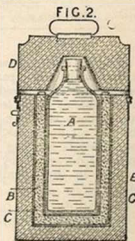

vessel containing it is placed in a jacketed vessel B containing a salt, as acetate of soda, which has been melted by immersing the vessel in boiling water. The vessel B is placed in an outer vessel C packed with a suitable non-conductor. The cover D is similarly packed.

12,927. Kitchen, J. July 4.

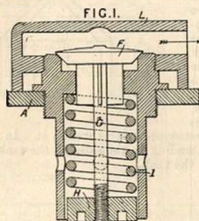

Heating water.—Relates to safety valves for use with boilers for heating apparatus &c. A casing G screws into the top A or the manhole cover of the boiler. Its upper end forms a seating for a valve F which is acted on by a spring I adjusted by a nut L. The valve is enclosed in a cover H whose opening is directed up a chimney or other passage.

13,166. Shore, W., and Coupe, G. E. July 7.

Steam traps.—Steam and condensation water enter the lower trap casing R by the pipe N, causing the pivoted ball P to lift, and by means of the pin J straighten the toggle joint H, E against a spring h, thereby pulling over the valve Q by means of the finger L. Steam from the boiler now enters the trap by the ports A and D, forcing

the condensation water into the upper trap I by the pipe O, while the air and steam escape by the outlets D', E' into the atmosphere. Attached to the casing I is a piston valve A', with two unequal

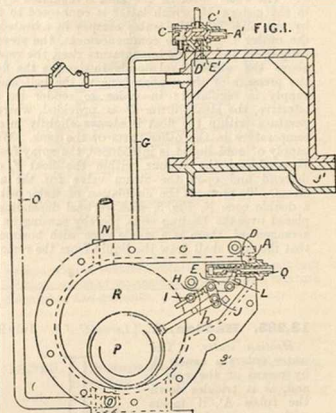

pistons c, c', the left hand side of the valve casing being in communication with the casing R by the pipe G, the right hand side with the atmosphere, while the space between the two pistons is open to steam pressure from the boiler. At the conclusion of the exhaust from the lower trap, the piston valve A' is forced over to the right, causing steam at full pressure to enter the casing I and force the condensation water back to the boiler by the pipe J'. The valve A' is now forced back to its old position by atmospheric pressure, and the action above described commences anew.

13,281. Mackay, F. N. July 9.

Heating water; thermostats; boiling pans.

The tank or cistern A is provided with heating coils D, supplied with steam from the pipe d, the amount of steam supplied being determined by the position of the drum F, pivoted at J' and weighted directly by means of the weights K' and also by the weights J'

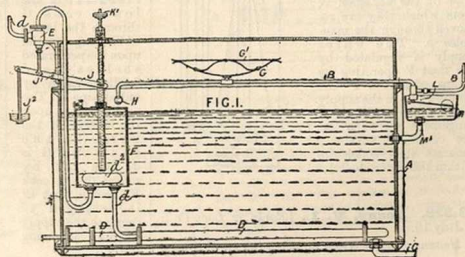

hanging from the lever arm J, whereby the opening of the steam valve E is regulated. The water or other liquid is admitted to the tank by the dish G connected to the supply pipe B, and provided with a slit flexible cover G¹ for distributing the water in a thin stream, while a separate nozzle H sprays water upon the drum F. The water level in the tank is regulated by a ball cock L in the cistern M, which latter is connected to the cistern A by the pipe M¹; the water escapes in a heated condition by the outlet C. At the commencement, the steam valve E is fully open, and, as the temperature rises, the vapour collecting above the water level tends to depress the float F against the pressure of the vapour beneath the bell, and so the steam supply is regulated; in order to render the control more effective, the steam drum d² is provided, whereby the temperature within the float is always slightly in excess of the temperature in the other parts of the tank. When a further supply of cold liquid is introduced, the spray from the nozzle H condenses the vapour within the float F, causing it to descend and open the steam valve for the admittance of steam. To promote the circulation of water within the tank, a double cone N, Fig. 3, with vertical depending tubes N¹, is placed over the heating coils, thereby causing an induced current of water through it. In a modified arrangement, there is a single cone with horizontal tubes extending to the sides of the tank, to ensure that the cone shall draw the liquid from the remotest parts of the tank.

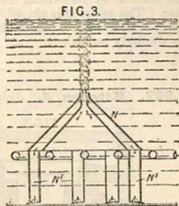

13,283. Haddan, R., [Leroy, C. J.]. July 9.

Heating water.—The water enters a casing A by means of the rose a and, as it trickles down the tubes A¹, it meets with an upward current of exhaust steam from the inlet T and pipe H, whereby it becomes heated and falls to the base of the chamber B, from which latter the clear water is run off by a pipe I into a second reservoir, finally escaping by the pipe I connected to the coil C. The salts and impurities in the water are precipitated by this heating upon the floor of the chamber B, from which they are removed through the man-holes o. The water supply is regulated by the float F operating by means of a rack F¹ the pinion F² upon the supply tap, and in a modified arrangement the tubes A¹ are contained within a separate shell which fits within the outer shell A.

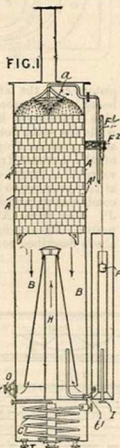

a pipe E flows over the plates D in a thin stream and comes in contact with the exhaust steam from an engine entering by the pipe H and escaping by the pipe H¹. The exhaust steam raises the temperature of the water and causes it to deposit its lime and mineral matters upon the shelves D before entering the lower part of the casing G by means of the pipe F. The water rises from the lower cone G through the layers of filtering material upon the perforated shelves C, and finally escapes by outlet pipe I. The oil collecting upon the surface of the water in the chamber G is drawn off by means of the cock K, and a float E¹ is arranged to regulate the supply of the incoming water.

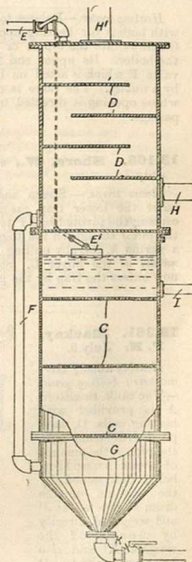

13,338. Feeny, V. I., [Parks & Lacy Co.]. July 10.

Heating water.—Water entering the apparatus by

13,359. Tallett, W. July 10.

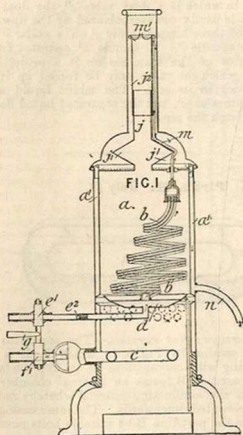

Heating water, geysers for. A jacketed casing *a* has a number of coiled water tubes *b* arranged pyramid fashion and connected below to a shallow hot water chamber *d* supplied by the tap *e*. A powerful gas burner *c* is arranged below for heating the coils, and the waste products of combustion, after circulating in the chamber *a*, escape by the chimney *j*, while the water circulating in the tubes *b* rises by the pipe *m* to the perforated ring pipe *m* above, from whence it trickles down between the swelled flue pipe *j*, *j* and jacket *a*, finally escaping in a highly heated condition at the outlet *n*. The gas and water taps *f*, *e* respectively are turned on and off simultaneously by the handle *g*, and a check valve *e* moderates the water supply, while a pilot light, not shown, serves for lighting the burner *c*.

13,642. Hill, F. B., and Brett, R. D. July 14.

Heating water, boilers for. The boiler is formed of two separate shells or casings *A* and *B* connected by the flanged joints *A*, *B* and provided with inlets and outlets *E* and *F* respectively. Inclined water tubes *C* traverse the heating chamber, and the heating source is furnished by a lamp or burner *D* of the type described in Specification No. 1231, A.D. 1894. The uptake flue *G* extends through a stuffing-box *H* in the outer shell, thus forming an

expansion joint. The tubes *C* fit into suitable recesses *a* in the inner shell of the boiler, and are

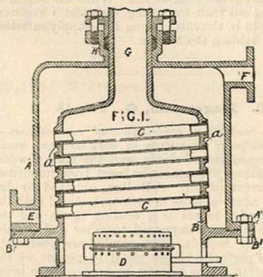

packed with a suitable cement, such as a mixture of black oxide of manganese and oil, or a mixture of sulphur and graphite.

13,792. Thompson, W. P., [Humphrey, A. H., Humphrey, F. J., and Humphrey, H. S.] July 17.

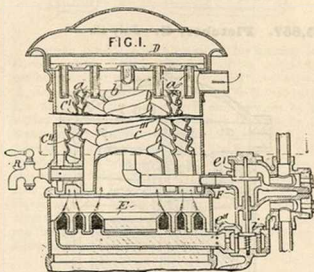

Heating water.—The apparatus is intended for supplying hot water for use in barbers' shops and bath-rooms. Water is delivered into an upper receptacle *D* by a pipe *b*, from whence it is caused to flow through apertures in the pockets *a* on to the spiral corrugations of the casings *C*, *C*¹, *C*², being finally drawn off in a heated condition by the tap *R*. The water is heated by a treble-ringed gas burner *E* below, and the supply of gas is controlled by a spring loaded

valve e^1 , the opening being regulated by the pressure and flow of water acting upon the upper disc valve e^2 , so arranged that when no water is flowing the spring closes both valves. When the burner E is swung out from the casing, the inlet i registers with a slit in the valve casing F to supply sufficient gas for lighting the burner.

13,838. Hagemann, G. July 18.

Non-conducting coverings and compositions.—Waste chips or fragments of cork are cut small, sorted by means of sieves, and the cork powders thus obtained are separately freed from impurities by a current of air. Collodion, obtained by dissolving nitro-cellulose in acetone, is mixed with the cork powder to act as a binding agent, and the mixture is then compressed together and formed in suitable moulds. The moulds are preferably made of perforated sheet metal to permit of the evaporation of the acetone, this evaporation being facilitated by heating the moulds in closed chambers. A pipe leads from the chambers through a cooling room wherein the vapours of the solvent are condensed. The flexibility of the cork is increased by the addition of a fatty oil, and its inflammability may be decreased by the addition of sulphate of ammonia or other fireproofing material. For jacketing steam pipes or for use as building material, an addition of kieselguhr is recommended; in other cases fibrous material may be employed.

13,857. Fletcher, G. July 18.

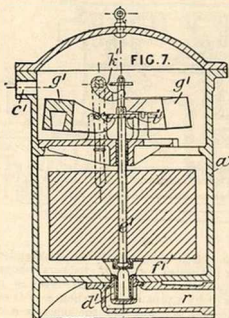

Steam traps.—The outlet for condensed products from the heating drum of apparatus for distilling, concentrating, and evaporating liquids is provided

with a trap, Fig. 7, for separating steam or vapour from the condensed liquid. It consists of a closed vessel a^1 , in which is a float valve d^1 , the float f^1 of which is partly counterbalanced by the upward pressure of three hinged levers g^1 on a collar i^1 on the valve spindle e^1 . A spindle l^1 operated from the exterior of the trap, has on it a projecting finger by which the valve may be forced up if it should stick in its seat. The mixed liquid and vapour enters at c^1 , and the separated liquid flows away through the pipe r .

13,943. Piron, H. July 19.

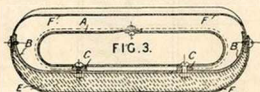

Bed warmers; foot warmers.—The apparatus is shown in section by Fig. 3, in which F, E is an outer casing with corrugations at its top surface, while a partition B forms an internal chamber to contain a non-conducting material whereby radiation is prevented downwards. The inner casing A is fixed to the partition B by suitable bolts passing through the distance pieces C so that there is an air space all round. To use the apparatus the inner casing is filled with incandescent silver sand through a suitable opening closed by a door, and the warmer is then ready for use, and may be applied as a foot warmer for railway and other carriages, or as a bed warmer, and for like purposes.

14,052. Harpur, W. July 21.

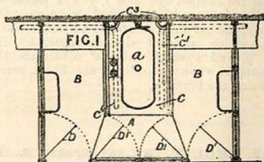

Heating bathrooms.—Steam or hot water pipes c^1 are fitted in the bath casing c , and hot air is supplied to the compartments by shafts c^2 , and through apertures or gratings in the bath casing.

1894]

ABRIDGMENT CLASS HEATING.

14,086. Beck, F. W. July 23.

Heating water, boilers for. The inner shell A of the annular boiler E is made in the form of a lamp chimney, so as to readily fit on to an oil lamp, the hot air and gases from which circulate around the coils C, G connected to the top of the boiler, and thereby heat the water contained within the annular space E. Suitable flow and return pipes F, H are provided for the circulation of water to the heating-coils or radiators, and a sight hole D permits inspection of the lamp, while a cover B causes the hot products of combustion to circulate round the external shell of the annulus E before escaping into the chimney or flue.

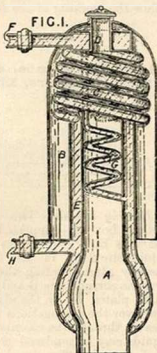

14,110. Flachsmann, A. July 23.

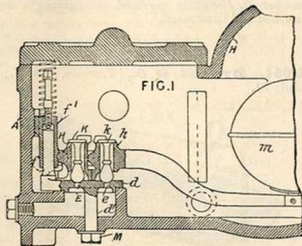

Steam traps.—Within the casing A are arranged a pair of valves K, k, placed in suitable recesses in the knuckle jointed and pivoted castings H, h attached to the sliding collar f' on the spindle f; the valves K, k control the outlets E, e in the plate d, which latter is kept in place by the bolt d' and nut M. As the water of condensation rises in the casing, it lifts the float m and causes the smaller valve casing h to rotate upon its pivots and swing the valve k clear of the opening e. If the outlet is not sufficient, the condensed water will lift the float still further, and in a similar manner

open the outlet E. In a modified arrangement, the smaller valve lifts first and controls an outlet made through the larger valve, and if the outlet is insufficient the large valve is lifted and uncloses a larger escape port.

14,184. Kleemann, F. July 24.

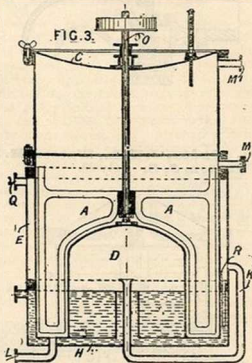

Heating liquids.—An apparatus for heating and concentrating liquids consists of a cylindrical casing provided with a hinged cover C and stirrers A, driven by a vertical shaft O. The liquid enters the apparatus by the pipe L and escapes by the outlet M, being heated as it passes through by the water jacket H and by steam which enters by the pipe Q, and after circulating in the casing E is led by the pipe K into the bell D, where it condenses; the water condensing in the jacket E is delivered into the jacket H by the pipe R. At the start, the liquid can be heated by warm water only, and afterwards by steam in addition. When liquids are being concentrated, the vapour therefrom is allowed to escape by the pipe M'.

14,499. Edge, J., and Richards, T. P. July 28.

Valves and cocks.—The valve a is carried on a spindle b and is forced upwards against its seat by a spring d so as to act as a safety valve. The valve is depressed for drawing off water by the usual screw down spindle f, which is formed with a recess for the end of the spindle b.

(For Drawing see next page.)

14,499.

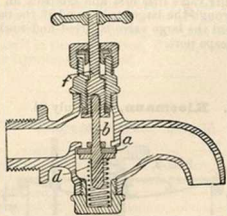

exercises an upward thrust on the float. In one form of the apparatus, a hand-lever is provided to allow the working of the feed valve to be tested.

14,554. Lawrence, A., and Bennett & Sons & Shears, Limited. July 28.

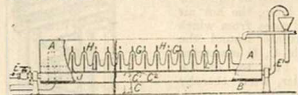

14,531. Ogden, J. E. L., Watson, H. B., and Watson, J. S. July 28.

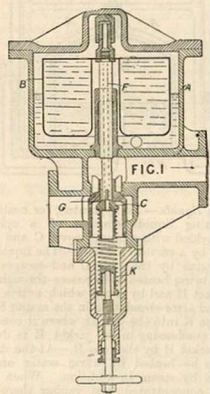

Heating liquids. The apparatus consists of a hollow box A, supported on hollow trunnion bearings E, E', by means of which the heating liquid circulates in the corrugated chamber L, thereby attempering the wort &c., which flows over the corrugations G and between the perforated baffle plates H, or the attempering liquid may flow over the corrugations G and the liquid to be treated through the chamber L. The path of the liquids may be rendered more tortuous by means of T-shaped baffles placed between the plates H, and also by perforated diaphragm plates attached to the divisions J. When the trunnions are disconnected, the apparatus is supported by a pillar C and ball pivoted bracket C', and the cleaning of the apparatus is effected by means of a perforated slide controlling the perforations in the upper side of the chamber B, whereby water can be forced through the chamber B, and away by the outlet chamber B. Slightly modified arrangements are described and illustrated.

14,651. Dymond, G. C., [Trudeau, J. A. G.]. July 31.

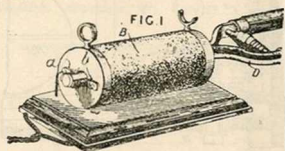

Heating water; boilers; water supply.—Consists in an adjustable float apparatus for controlling the opening or closure of a valve in the feed-pipe. The float B is enclosed in a casing A situated either within the boiler or merely connected with it, as in the illustration. The feed-valve G is indirectly controlled by the float through the medium of a pilot valve C carried by the spindle F. The latter is perforated from end to end, so as to be balanced as regards end pressure. Whenever the valve C drops, owing to a fall of the float, the main feed valve G follows it and admits feed to the boiler. The normal level may be regulated by more or less compressing a spring K, which

Heating by electricity.—Curling tongs, soldering irons, and laundry irons are heated by the Foucault currents produced by alternating currents in a coil of which the curling tongs &c form the core. In the form shown, the circuit is completed between two contact pieces a, b by the tongs &c. D, when the latter are inserted in the coil B. The coil may be lined with asbestos, mica, or other incombustible material.

14,659. **Rippingille, F. S.** July 31.

Heating buildings; heating air.—Within a casing H containing a lamp or heater A is formed a conical chamber D. The products of combustion from the heater A circulate within the chamber D, and thereby heat air entering the outer casing by the pipe E and escaping by the pipe F; baffle-plates are inserted in both chambers to promote the efficiency of the apparatus. The hot air may be used for heating green-houses, conservatories, and the like. Slightly modified forms of apparatus are described and illustrated.

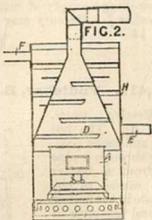

15,076.

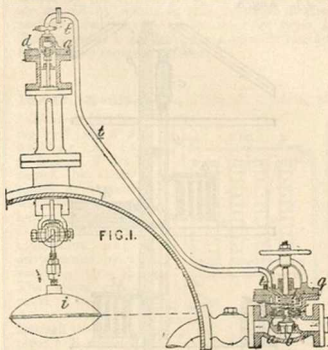
14,984. **Wilson, G. L.** Aug. 4.

Hot water bottles are made by forming the body *a* of a doll of india-rubber or other flexible waterproof material, and fitting it with a tube *b* and screw plug or equivalent device for emptying and filling.

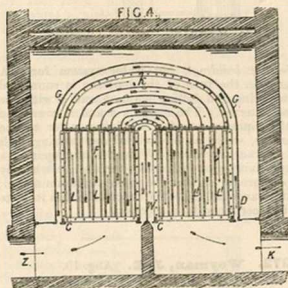
15,096. **Jaennigen, M. M.** Aug. 7.15,076. **Sandillon, F. M.** Aug. 7.

Heating water; boilers; water supply.—Consists in a float-apparatus, in which the main feed-valve is operated in accordance with the opening or closing of a small valve directly connected with the float. Fig. 1 shows one of the arrangements described in the Specification. The float *i* operates the small valve *d* controlling a passage *t* by which the space *q* behind a piston *a* may be exhausted. This piston is connected to the main feed-valve *b* and, being perforated, is normally in equilibrium. The perforation being, however, smaller than the valve *d*, whenever the latter is opened the pressure immediately preponderates on one side over that on the other, and the feed-valve is accordingly operated. Various modifications in detail as regards the form, disposition, and actuation of the valves *b* and *d* are described.

Heating air.—Within the fluted casings *F, F'*, connected by channels *k*, steam is allowed to circulate from the inlet *D* to the outlet *C*, while air is drawn in from the flue *Z* and circulates through the channels *L, L'* thereby becoming heated and finally escapes into the outlet flue *K*. The casing *G* and baffle-plate *W* ensure that the air traverses the channels *L, L'*, and, if necessary, a fan may be employed to assist the flow of air round the casing. Hot water may be used instead of steam.

(For Drawing see next column.)

15,155. **Boult, A. J.**, [Sander, J., and Kühne, J.]. Aug. 8.

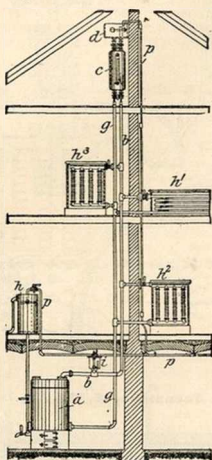

Heating buildings, hot water system for. A boiler *a* in the base of the building is connected by the rising and falling mains *b* and *g* with the closed cistern *c*. The cisterns *h* and *d* connected by the piping *p* are for supplying water to the apparatus, while *h*¹, *h*², and *h*³ are heating coils and *i* is an air valve. With this arrangement a vacuum exists above the water surface in *c*, whereby the pressure throughout the apparatus is diminished; a water-gauge is fixed to the cistern *c* so that its state can be ascertained by inspection.

15,272. **Weyman, J. E.** Aug. 10.

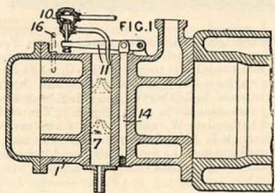

Thermostats for controlling the temperature of

oil engine vaporisers. A rod 14 of higher coefficient of expansion than the metal of the vaporiser 1 actuates through a lever 11 a valve 10 for controlling a supply of water running through the chamber 7. Mercury may be used instead of the rod 14.

15,413. **Fudickar, E.** Aug. 13.

Heating water, air, &c. The hot air and gases passing through a pipe *b* from a burner are caused to circulate in the hollow helical chamber *a* on to the outer surface of which water or air is led by means of a perforated pipe *l*, and after being heated is led away by the pipe *h*. The apparatus is especially useful for quickly heating water for baths. Modified forms are described and illustrated.

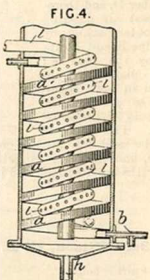

15,487. **Kowalski, H.** Aug. 14.

Heating water, apparatus for, used in connection with apparatus for filtering and purifying water. The heater consists of two chambers *C* and *D*, the former receiving the inflowing water, which is boiled in the latter. The chambers are separated by a partition *c*, and the chamber *C* contains a perforated partition *c*¹, the water level being slightly above the holes. A steam pipe *c*² passes through the partition *c*¹ and induces a flow of water down a pipe *c*³ into the boiler *D*. The cold water enters at *b*¹ and is discharged into the filtering apparatus through a pipe *d*¹ which is furnished with a thermometer *d*².

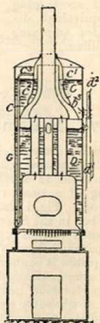

15,490. **Mewes, R. W.** Aug. 14.

Heating water, boilers for. The improvements applicable to various classes of boilers are shown in Fig. 1 in connection with a boiler of the vertical type. Between the furnace bottom and outer shell, a number of inlets D are provided through which air is supplied to fuel lying upon the furnace bottom. In addition, for smoke consuming, other tubes C are provided. By curving the plates of the furnace, staying may to some extent be dispensed with.

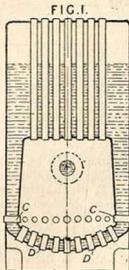

becomes heated and circulates in the direction shown by the arrows, giving up its heat to the air around by means of the extensive heating surface formed by the grills upon the pipes A. The apparatus is carried upon a suitable base for fixing in any required position.

15,612. **Boult, A. J.,** [Horn, P. R.]. Aug. 16.

Heating buildings.—Within a boiler A is a firebox F traversed by horizontal or vertical water tubes f and heated by a gas jet D; the smoke and combustion products escape by a vertical pipe E. The steam generated in the boiler A circulates through the grilled pipes b, B, thereby heating the air of the apartment in which it is placed, and finally drains back into the boiler by the pipes a.

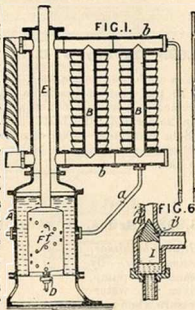

The stove is carried by a portable stand for fixing in any required position. For regulating the gas supply there is a U-tube containing mercury and on one side in free communication with the steam, while in the other tube floats a conical valve I, Fig. 6, controlling the opening d¹ for gas; as the steam pressure rises the gas is gradually cut off until, when the valve presses on its seat, only sufficient gas can traverse the serrations i¹ on the conical face of the valve to keep the burner alight. In modified constructions ball valves and double conical valves effect the same purpose.

15,547. **Preston, R. T., and Holden, J.** Aug. 15.

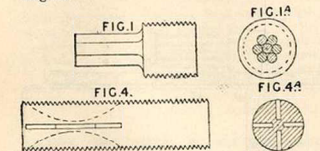

Heating water; boilers, stays for. Flexibility is imparted to stays by dividing up the portions between the ends into parts wholly or partly separated from each other. For example, as in Figs. 1, 1^A, the body of the stay is made up of single wires of convenient section, the mass of wire being twisted or straight and suitably joined at the ends for entering the boiler plates. In the case of solid stays, slots may be cut into them as shown in Figs. 4, 4^A.

15,606. **Boult, A. J.,** [Horn, P. R.]. Aug. 16.

Heating buildings.—Within the central chamber D of a stove or heating apparatus there is a heating cylinder F provided with horizontal or vertical water tubes f, a chimney G, and gas burner d. The water in the pipes A, b, c passing through the tubes

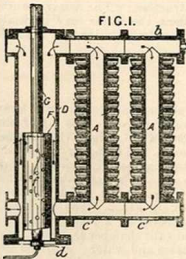

15,698. **Schindler, F. W.** Aug. 17.

Heating liquids by electricity.—A refractory heating block, composed of superposed halves a¹, a², has a number of channels q formed therein to receive the heating wires, which may be in two or more groups connected by a contact device such as that described in Specification No. 21,435, A.D. 1893, to regulate the heating effect. The wires are shown connected to the

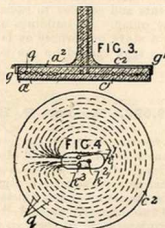

leads h^1 , h^2 , h^3 in three groups, and the block a^1 , a^2 is covered by a metal casing c^1 , c^2 with a screwed joint p^1 . The apparatus is immersed in the water or other liquid to be heated, and the current is controlled by the contact device above mentioned. Modified arrangements are described and illustrated in which the heating coils are disposed in rings and annular cylinders, while the enveloping casing has flanged joints.

15,885. McLay, J. C. S. Aug. 21.

Non-conducting composition.—A mixture is made of 70 per cent. of insoluble carbonate of lime obtained as a waste product in the manufacture of soap, 25 per cent. of asbestos fibre, and 5 per cent. of flour sweepings. The composition so made is applied as a covering to boilers, steam pipes, and the like.

16,593. Bruce, A. Aug. 31.

Heating buildings; heating water.—By means of a pump, driven by water-pressure when used in a building and by steam in the case of a train, hot water is forced round the heating system, suitable radiators being placed where required. In dwelling-houses the ordinary kitchen boiler b , Fig. 1, is coupled by a pipe a to the pump d and has a pipe a^1 running through the various apartments and coupled to radiators c , c^1 of ordinary construction. The water returns by a pipe a^2 to the pump. In buildings unprovided with kitchen boilers, the water may be heated in a coil placed in a stove or furnace as in Fig. 9; and in the case of railway trains the water is heated, by steam, in a tank carried on the locomotive-tender.

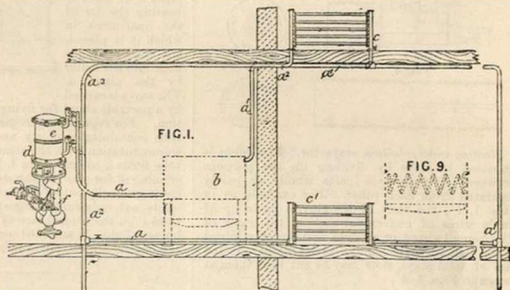

16,597. Roshier, F. H. Aug. 31.

Heating buildings &c.; heating water.—Heating conservatories, halls, and other buildings. Fig. 1 is a longitudinal section of a combined air and water heating apparatus for heating buildings, and Fig. 3 a cross-section of a modification. The boiler consists of two concentric tubes A , B connected at their ends, by plates C , C , to form an annular water-chamber which is provided with a filling tube G . Any steam or vapour generated escapes through an opening E into a chamber D containing a cold

16,058. Yates, J., and Yates, W.
Aug. 23.

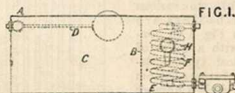

Heating water by means of steam. The tank A is divided into two compartments C and E by the partition B , which latter permits of free communication between the two compartments. The compartment C is kept filled with water by means of a float valve D , while a steam-coil F in the other compartment heats the water contained therein. The hot water is delivered by the tap H , while the exhaust steam is passed into the trap J .

water receptacle F in which raw steam and vapour are condensed. The top of the chamber D is perforated to allow the uncondensed vapours to escape. The boiler is heated by oil or gas jets in the chamber K , which is provided with air-inlets L , L , and a ventilating opening P covered with wire-gauze and which stands on feet on a bottom box R , Fig. 3. The products of combustion are collected by a hood M and pass up a flue-pipe J into the chamber D , where they are absorbed by the steam and water. A single straight flue, as shown in Fig. 1, may be employed, or two or more

similar ones, which may be water-jacketed, may be used, or the flues may be arranged as in Fig. 3. In another modification, the boiler consists of two

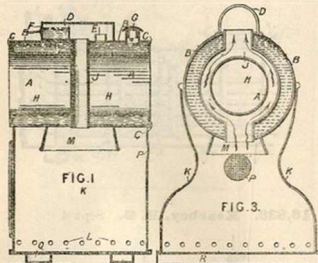

concentric water chambers separated by an air space and provided with vertical flues.

Heating air.—The air passing through the central flue H is employed to heat other apartments of the building, the boiler being used to heat the one in which it is placed.

16,654. Sheppard, J., and Dashwood, F. Sept. 1.

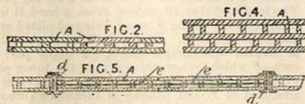

Heating buildings &c.—Columns, doors, floors, walls, roofs, partitions, shutters and other structures or parts thereof are constructed of hollow bricks or tiles A arranged to break joint. The hollow spaces may be filled with concrete, ground charcoal, silicate cotton, or other material, and unfilled spaces may be used for heating &c. The tiles may be glazed or ornamented, or they may be grooved to retain plaster.

16,728. Crossley, F. W., and Atkinson, J. Sept. 3.

Heating water and other liquids.—Relates chiefly to a form of cold air machine which may be used for transferring heat, condensing, cooling, refrigerating, or for the production of ice. The working fluid may consist of air, or condensable or incondensable gases, such as ammonia or a mixture thereof, used in an open or closed cycle. The apparatus consists of a cylinder C, Fig. 2,

with a long piston E. One end is used for drawing in through the valve F, lightly compressing, and transferring the gas to the other end of the

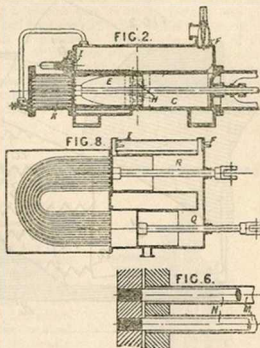

cylinder through the valve I. Here they are compressed into the condenser K where heat is extracted, and on the return stroke they expand and are subsequently expelled through openings H in the cylinder by a further charge from the charging end. In a modification shown in Fig. 8, two cylinders are used worked by cranks at about right angles. The ends R, Q are used for charging and the other ends are connected to the condenser. The condenser may consist of tubes M fixed in tube plates with rods N extending through them, as shown in Fig. 6. When used for heating, the fluid to be heated is circulated around the condensing tubes. The apparatus may be used for condensing and also for cooling air for ventilation. In Fig. 2, the driving crank is placed at the condenser end, and return connecting rods used, but other means of driving may be employed.

16,744. Crompton, R. E. B., and Dowsing, H. J. Sept. 3.

Heating by electricity.—The connecting wire or tape a of the heating pad may be crimped by the apparatus described in Specification No. 21,752, A.D. 1893, or in any other convenient way, in order to increase the resistance and distribute the heating effect. The conductors thus treated are laid between the asbestos cloths b, b' and sewn firmly thereto, and the coverings afterwards receive a waterproof coating by vulcanizing, or the like, in order to unite the asbestos material and to exclude moisture. The pad thus formed may be enclosed in flannel or in rubber d for applications to the body of the patient, suitable

connections being made between the heating wires and the source of electrical supply.

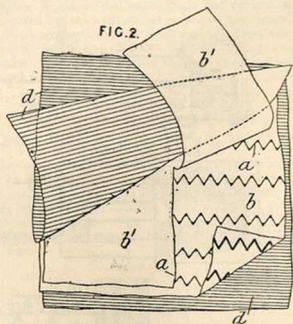

16,756. Golby, F. W., [Swiecianowski, J.]. Sept. 3.

Heating air; heating water in baths.—The furnace or stove used is made, as shown in Fig. 2, of a triangular form externally. Internally it is partially divided by the depending web or curtain *d*. In the case illustrated an ash tray *i* is provided. Air to be heated enters the chamber *j* by the passage *k*, while air for combustion is regulated by the grid-valve *o*. When immersed in the water to be heated, air for combustion is passed to the fire through a convenient channel.

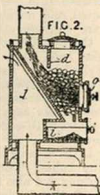

16,837. Keasbey, H. G. Sept. 4.

Heating water by furnace gases. Furnace gases are passed through a series of tubes around which the feedwater is caused to circulate in a zig-zag path. The heating tubes *B* are suitably connected to a steam boiler, so that the gases shall pass through them into a chamber *F* in the shell *A* beneath a smokestack *G*. The space around the tubes is divided into compartments, the upper part of each of which communicates with the lower part of the next through pipes *D*¹, *D*². Feedwater is admitted at *E* and, passing in succession through all the compartments, is delivered at *J*. The compartments have each a blow-off pipe *K* for the

removal of sediment and deposit, and the chamber *F* is provided with doors *L* for obtaining access to the tubes and chamber for cleaning and repairs.

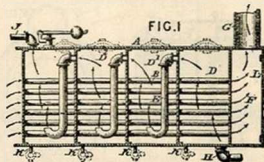

16,838. Keasbey, H. G. Sept. 4.

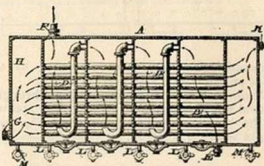

Heating water, surface apparatus for. Steam is passed through a series of tubes around which the feedwater is caused to circulate in a zig-zag path. The heating-tubes *B*¹ extend from a head *H* to a head *K* in the casing *A*, steam being admitted at *G* and discharge at *K*. The space around the tubes is divided into compartments, the upper part of each of which communicates with the lower part of the next through pipes *D*, *D*¹. Feedwater is admitted at *E*, and, passing in succession through all the compartments, is delivered at *F*. The heads and compartments have each a blow-off pipe *L*, *M* for the removal of sediment and deposit.

16,938. Herscher, E. Sept. 5.

Heating and sterilizing water &c.—Water or other liquid supplied to a tank *A*, fitted with a ball-cock or other constant level apparatus, passes by a nozzle *b*, a valve *b*¹, nozzle *c*, and pipe *d* to the outer part of a cooler *C*. Ascending in this, any excess escapes by a pipe *q*, *r*, and the remainder passes by the pipe *f*, *g* into the extension *X*, *X*¹ of the boiler *B*. Here it is heated by gas burners or other suitable means, and the steam produced raises the bell *S*, *S*¹, and thereby the valve rod *s*, *b*¹, which thus admits water to the boiler through the cooler only when the liquid is in ebullition. The transfer of boiling water to the boiler is effected by the steam rising into the bell *T*, *T*¹ and expelling hot water by the hole *i* into the top of the boiler. Boiling water is thus caused to overflow by the pipe *j*, *k* into the inverted bell *V*, *V*¹, whence it is

carried by the steam up the pipe *l*, *m* to the cooler *C*. The cooled water passes out at *n* and overflows at *p*. In simpler forms of apparatus, the bell *S*, *S*¹,

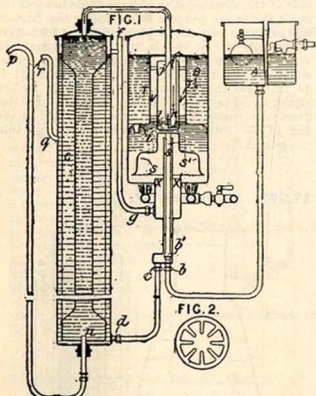

rod *s*, *b*¹, and valve *b*, *b*¹ are dispensed with. The opening *r* is then provided with a tap, or the pipe *q*, *r* is entirely dispensed with when strong cooling is not necessary.

16,973. Sewell, J. C. Sept. 6.

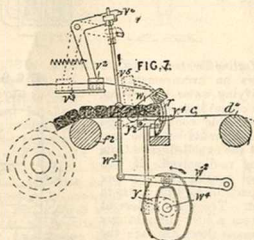

Non-conducting coverings and compositions.—Relates to apparatus for fastening pads of silicate cotton, slag wool, and the like to wire sheeting or webbing *c* stretched over the rollers *f*², *d*¹ so that it can be advanced by ratchet mechanism. The needle *r* upon the pivoted lever *v* is operated from the shaft *w*¹ by means of the cam *w*¹ and levers *w*², *w*³, while the shuttle *y*¹ is operated by the cam *y* and lever *y*². The wire is supplied to the needle *r* through a suitable tension arrangement, consisting

of a clamping device *v*² sliding in bearings *v*³ and controlled in position by the bell crank lever *v*⁴ and link *v*⁵. The needle *r* passes through the web *c* to form a shed or opening beneath, through which opening a second wire is drawn from a reel not shown, and bent over the edge of the web to secure the pads in position. During the rising of the needles and at the time when they are just raised clear of the pad, the web is advanced by the ratchet wheel mechanism, while at the same time a supply belt advances a row of pads for the next operation. In a modified arrangement, the apparatus is worked by hand.

17,130. Stotz, P., and Schindler-Jenny, F. W. Sept. 8.

Heating liquids by electricity.—The liquid to be heated enters by the pipe *s*, and traverses the annular space between the plain or corrugated cylinders *a*, *b*, and afterwards the central cylinder *c*, finally escaping by the outlet *r*. The heating of the liquid is effected by means of an electric circuit *e* in the annular space between the cylinders *b*, *c*, and connected to a switch, so that when the water is turned on or off the circuit is made or broken. The apparatus is lagged with wood *l* or the like; a slightly modified arrangement is described and illustrated.

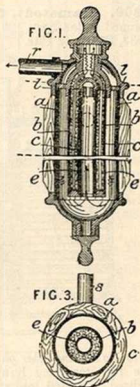

17,174. Kok, L. G. Sept. 10. Drawings to Specification.

Heating buildings &c.—In the Provisional Specification, radiating boxes are described and illustrated, through which the products of combustion take a to and fro course.

17,259. Boulton, A. J., [Whitney, C. W.]. Sept. 11.

Heating water, boilers for. Heat distributors in the form of helical strips *c* are applied to smoke tubes, such strips, however, not being in contact with the sides of the tubes in which they are placed. The strips may be used in connection

with the end protector F, such as is described in Specification No. 21,717, A.D. 1893, or with plain thimbles or other suitable devices. The strips,

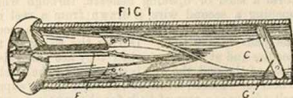

which may be centrally supported by cross-pieces G, are particularly suitable for vertical boilers when convenient means for hanging the strips in the tubes are provided.

17,309. **Ramstedt, C. W.** Sept. 11. [Date claimed under SEC. 103 of PATENTS &c. ACT, 1883, February 12th.]

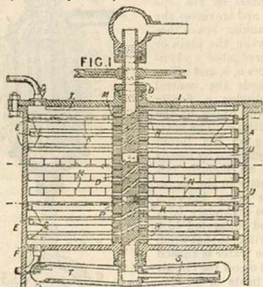

Heating air and other gases, apparatus for, applicable for sterilizing liquids. The liquid to be sterilized is passed into a chamber A by a pipe F, and passes radially along heating or cooling vessels E, which alternately extend to the wall of the chamber and fall short thereof, as shown. The wider vessels E are provided with openings H near the centre for the upward passage of the liquid. These vessels are keyed upon a shaft D, through which the steam or water for heating or cooling is supplied, is mounted in bearings in the top and bottom of the chamber A, and it is provided with suitable passages M for conducting the steam or water from one vessel E to the next. The vessels E, as shown at the upper part of the chamber, illustrate a form adapted for hot or cold water. The water enters the upper part of the vessel, then passes through holes L in the partition K into the lower part of the vessel, and finally passes by the hole M into the next vessel. The lower vessels, as shown, illustrate a form adapted for steam circulation. The steam enters these and is spread therein by the inlet P, and is led thence by the perforated pipe Q to the outlet R, which conducts it to the next vessel. Other forms of vessel E are described,

including the middle ones shown in the Figure, which are provided with spiral partitions N. Brushes U extend between the vessels E from one side of the chamber at an oblique angle towards the shaft D, for the purpose of increasing the friction and exchange of heat for preventing the formation of deposits on the vessels, and for conducting the stream of liquid to be pasteurized in a radial direction. Radial rods I are fixed to the shaft D to facilitate the discharge of the liquid by the outlet G. For facilitating the discharge of water from the vessels E, a bent tube S is fitted to the end of the rotary shaft D, which discharges into the trough T.

17,372. **Lawrence, W.** Sept. 12.

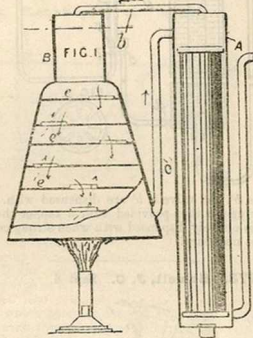

Heating water.—Fig. 1 shows an arrangement for purifying water by heating. The object is to arrest as far as possible convection and other currents so as to prevent the expelled gases from being re-dissolved. B is a vessel containing a number of partitions e with holes in them. The water enters at b from a heat interchanger A, passes down through the partitions to the lowest compartment, where it boils, and thence returns to the heat interchanger through a pipe c. Gases and steam pass upwards through the holes in the partitions e. The apparatus may be modified in various ways, and, when constructed on a large scale, has revoluble scrapers for collecting deposited sediment. Fig. 9 shows an apparatus for use with kitchen boilers. Pipes q and p lead respectively to and from the top cistern, b and c from and to the

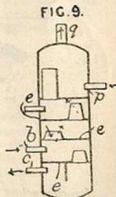

boiler. The arrangement of internal partitions prevents the waters from mixing excepting for what is required to replace water drawn off.

17,605. Hiller, E. G., and Hiller, H.
Sept. 17.

Heating water.—The invention consists of enclosing a safety valve, for water heating apparatus, in a case so as to protect it from dirt. The dead weight valve *a* is enclosed in a cover *c* having a passage *c'* for the escaping water or steam. A plug *d* passes loosely through the cover *c'* of the case and engages with a slot or notch *a'* in the upper part of the valve, which can thus be turned periodically so as to prevent its adhering to its seat. Should the passage *c'* become blocked, the fluid escapes by the plug *d*.

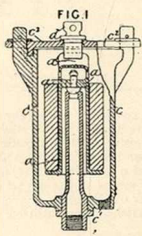

17,805. Bannister, M. C. Sept. 19.

Non-conducting coverings.—Paddy-busk, alone or in combination with other non-conductors, is employed in the manufacture. It may be placed within a jacket, preferably of some non-conductor, such as asbestos board, wiledsen paper, mill-board, or asphalt, may be enclosed in bags of textile material, or may be mixed with asbestos, asphalt, silicate cotton, Portland cement, &c. to form slabs which may be attached to the vessel to be protected in any convenient way.

18,365. Perkins, L. P., and Buck, G. F.
Sept. 28.

Heating water, sectional boilers for. Improvements on the invention described in Specification No. 14,294, A.D. 1893, which provides tubes hermetically sealed and partly filled with water, as the medium for transferring heat from the furnace to the liquid in the boiler proper. The present invention furnishes a variety of arrangements and combinations of these sealed tubes. The illustration shows the boiler proper as a

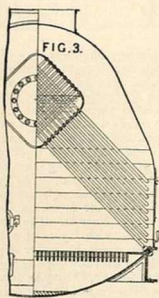

square sectioned drum on edge, having the tubes extending parallel to one another from two sides of it and crossing within it where they act as stays. Some of the tubes support the boiler in

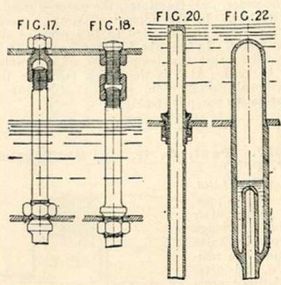

the furnace shell. In modifications, the drum is of oval section or is conical or is a flat box forming the furnace front, or a kettle shaped boiler is used, and the tubes diverge or converge from it. These tubes are also set across the flues of Lancashire boilers, in the fire tubes of vertical boilers, or in locomotive fire boxes, and are used with watertube boilers. The compound tube shown in Fig. 22 may be used.

Securing tubes.—In Figs. 17 and 18, the tubes acting as stays are shown secured to one boiler plate by collar or nut, and to the other by a screwed socket or a bolt and a right and left handed nut. In Fig. 20 the screw collar is shown as brazed on the tube but it may be deposited electrically.

18,434. Reck, A. B. Sept. 28.

Heating by steam circulation.—Relates to automatic pressure regulators for steam heating apparatus &c. The chamber *O*, in which an even pressure is to be maintained, is placed in communication with a water receptacle *A*, connected with a second water receptacle *B* at a higher level. In the latter there is a float *F* connected to a lever *L* operating the valve *V*, through which steam is supplied to the chamber *O*. The float may be replaced by a diaphragm, and the water column may be divided into two or more parts separated by air spaces.

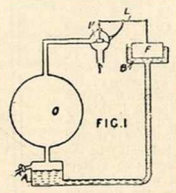

18,515. Holmes, D. M. Sept. 29.

Boiling pans.—Relates to the heating of the vessel containing coating material for coating creams &c. In order to maintain the temperature of the water jacket uniform, the water is caused to circulate. In the apparatus shown, a small rotary pump 6 is connected to two parts of the water jacket. In the tube 4, a thermometer 11 is arranged so that the temperature of the water may be read. At 3 is the filling pipe. In the Provisional Specification, it is stated that a reciprocating pump is employed.

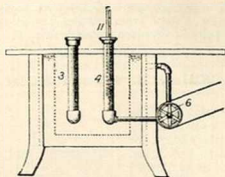

18,657. Paul, A. G., and Skiffington, W. P. Oct. 2.

Heating buildings.—High pressure steam, after passing through the reducing valve *c*, enters the radiator *a*, and after circulating therein escapes by the outlet pipe *d* and is condensed in the closed tank *e*. An exhaust ejector *h* is connected to both the radiator *a* and the tank *e* by the pipes *f* and *j* respectively to draw off air from the system so as to allow steam of less atmospheric pressure to be used for heating purposes. In modified arrangements, the condensed water flows away through the steam supply pipe, and several radiators may be fed from one common supply pipe.

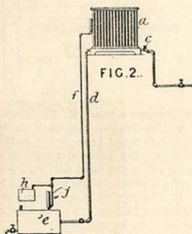

18,664. Paul, A. G. Oct. 2.

Heating buildings.—Hot water from the range boiler *g* is caused to circulate through the vessel *h* by means of the flow and return pipes *k, j*, thereby heating the water contained in the coil *c* belonging to the circulating system of which *b* and *d* are the flow and return pipes respectively. The radiators *a* are connected by branches to the air exhaust pipe *n* and

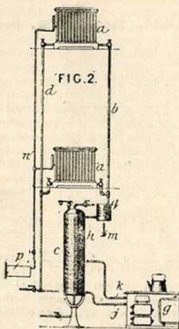

to an ejector *p*, whereby the pressure in the system is reduced to enable steam to be formed below the pressure of the atmosphere. To assist the heating operations of the range boiler *g*, there is an auxiliary coil *q* contained in a suitable casing and heated by means of the gas jet *m*. With this system all risk of explosion is avoided and the waste heat of a kitchen range utilized.

18,711. Sayer, R. C. Oct. 3

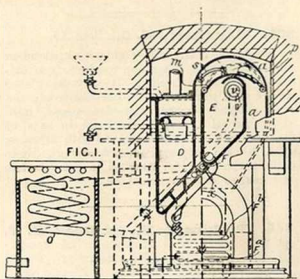

Heating buildings &c.—Relates to a system of producing draughts in stove flues and filtering the smoke. The flue *a* is curved as shown and is fitted with a pivoted damper *m* carrying a sieve *p* and operated through links *s*. The heavier part of the smoke is deflected by the damper into a soot depositing chamber *E* and from thence passes through a grid *r* to a worm through the bars of the fender, a drying horse &c. *O*, and returns by a pipe to the flue *a*. The lighter portions of the fumes pass through the sieve *p* and are carried by a jet of air or steam issuing from a nozzle *F* through a filter *D*. The filter is fitted with plates and filled with layers of coke, charcoal, &c., which is kept moist by water supplied from a suitable cock, an overflow pipe being also provided. Air or steam jets *F*¹, *F*² may be arranged below the grates. The filtering material is burnt after use.

1894]

ABRIDGMENT CLASS HEATING.

18,872. **Smith, A. H.** Oct. 5. [Grant of Patent refused.]

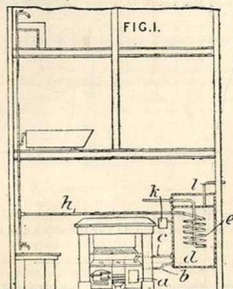

Heating water.—Water from the kitchen boiler *a* is caused to circulate in the tank *d* by means of the flow and return pipes *c, b*, thereby heating the water contained in the coil *e* and causing a circulation of hot water in the distribution pipe *h*. A supply cistern *k* is fitted to the tank *d* and a pipe *l* conveys away steam while a partition above the coil forms a separate condensation chamber.

18,987. **Softly, J. T.** Oct. 6.

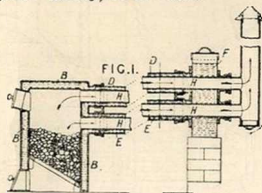

Heating buildings &c.—The hot water heating pipes *D, E*, connecting the boiler *B* and circulating tank *F*, are traversed by the flue pipes *H*, thereby economizing heat and reducing the amount of water in the system.

19,184. **Davis, J. R.** Oct. 9.

Heating by electricity; foot warmers.—Relates to electrical heating appliances such as furnaces, ovens, foot warmers, pads, &c., applicable also for use with incubators, artificial hot beds for plant culture, and for generating steam within and exploding water cartridges or shells for blasting &c. Consists mainly in the use of a heating medium composed of a mixture of carbon particles, such as pulverized plumbago or graphite, and an inert refractory non-conducting material such as

slaked lime, magnesia, alumina, or silica. The proportions of the materials depend upon the heat which is required, an increase in the amount of carbon resulting in the production of a higher

FIG. 6.

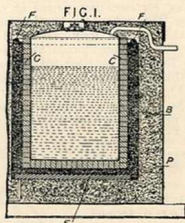
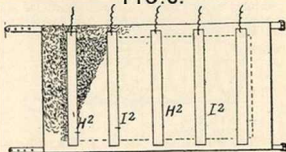

temperature. Fig. 1 shows the application of the invention to a steam generating furnace. The heating material *B* is enclosed between a layer *C* of refractory non-conducting material such as fire brick and a packing *P* of inert materials such as those forming part of the heating medium. The electrodes consist of a cast-iron plate *E* and a cast-iron ring *F*. When applied to a foot warmer, as shown in Fig. 5, the heating material *C* is contained in a casing *A* of wood, canvas covered with asbestos, &c. The electrodes consist of a conical plate *D* and a ring *E* triangular in cross section, and are protected by a thin metal sheet *K* embedded in mineral wool, asbestos, &c., which is provided with an external covering of carpet &c. In the portable foot warmer or body pad shown in Fig. 6, the case is of flexible material, and the electrodes are arranged parallel to each other to permit of the folding of the pad &c.

19,233. **Keith, J.** Oct. 10.

Heating buildings &c., radiators for. Each section is composed of two or more vertical tubes *A, B* of oval or like cross section, connected together at their upper ends and having

a central air space D between them. The sections are connected together by screwed nipples F with internal flanges L for engaging the

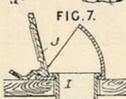
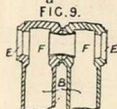
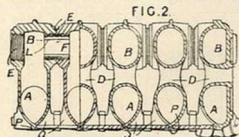

tool, or the nipples may be expanded into conical orifices E, Fig. 9. The pins P are provided with orifices for inserting panels or ornamental pieces Q, so that when the sections are screwed together the panels may be held securely, and in modified arrangements the sections are tapered so that the radiator may be circular in plan. At the base of the apparatus there are flap valves J, Fig. 7, controlling fresh air inlets I, whereby the entering air is caused to circulate around the radiator and become heated.

19,234. Keith, J. Oct. 10.

Heating water, boilers for. The boiler is of the annular dome topped type, having one or more water tubes J extending across the combustion chamber D, and provided with a charging doorway and smoke outlet G'. The boiler is mounted upon an annular brick lined fire-ring F carried by the base E, which latter has a pivoted fire-grate C'. The outflow and return pipes are connected up to suitable flanges on the boiler, while openings O, closed by suitable doors, are formed in the outer shell opposite to the water-tubes J around the lower part and at P in the top of the boiler for cleaning out sediment.

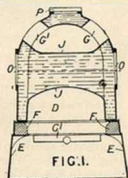

19,311. Cinnamon, J. Oct. 11.

Heating buildings &c.—A coil of electrically-heated wire, a steam radiator, or other heat-giving source C is placed in the focus of the umbrella-shaped reflector A, whereby heat rays are diffused through the room or apartment, raising the temperature of the air therein; a reflector G cuts off the rays of heat reflected directly downwards.

The hot air rises and accumulates under the reflector A and, forcing back the flap-valves E', escapes by the shaft D, while fresh air enters the

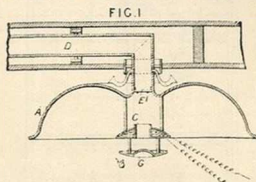

room by the usual openings. A modified apparatus is described adapted for the sides and corners of a room.

19,383. Turner, R. H., and Whiteley, J. Oct. 12.

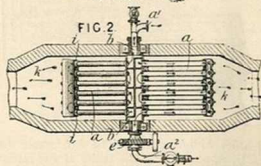
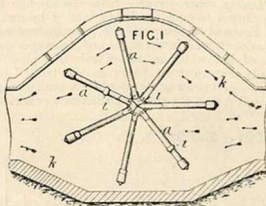

Heating liquids.—The apparatus consists of a number of tubes a set radially upon the drum b, and so connected at their inner and outer ends that the liquid entering by the trunnion a' passes through the tubes, as shown by the arrows, and escapes by the outlet pipe a'', thereby becoming heated by the waste gases circulating in the chamber k communicating with the chimney and boiler flue. In order to promote the efficiency of the apparatus, it is rotated by the worm gearing e, and scrapers i upon the tubes by their continual motion keep the pipes clean. Slightly modified forms are described and illustrated in which the pipes are connected in pairs, while two heaters may work together in the same chamber.

19,580. Williams, C. Oct. 15.

Non-conducting coverings and compositions.—Relates to compositions for making slabs, plates, sheets, &c. for ceilings, roofs, walls, doors, partitions for ships, panels, refrigerating chambers, &c., or the mixture may be used as a cement, paint, or wash. Minerals containing iron and magnesium silicates such as asbestos, chrysotile, talc, steatite, actinolite, picroilite, antholite, metaxite, crocidolite, arfvedsonite, and glauconite are pulverized, mixed, and saturated with a solution of barium chloride, or magnesium chloride, or a mixture of both solutions. The plastic fibrous mixture is pressed, rolled, or moulded into plain, corrugated, ribbed, embossed or flanged plates or sheets. A network or fabric of wires, yarn, thread, or the like, or a skeleton of metal may be introduced into the material, or the plates may be covered or backed with a fabric or solid substance.

19,592. Newton, H. E., [Oakman, R. N.]. Oct. 15.

Heating buildings &c.—The apparatus is intended for heating both air and water, and is shown in sectional elevation by Fig. 3, in which C is a burner supplied with a mixed jet of gas and air by the pipe V. The products of combustion, after circulating in the combustion chamber B and flue B', pass by the crown F and corrugated down-take tubes G to the chimney flue P, while an ascending current of cold air enters the casing A from below, and after circulating around the tubes G and flue E, escapes by the outlet pipes K' in the upper casing K to be used for warming purposes. At the crown F there is a water boiler L, with inlet and outlet

tubes I, I' for the supply of hot water to suitable heating apparatus, while in order to create a strong draught at the commencement there is a small

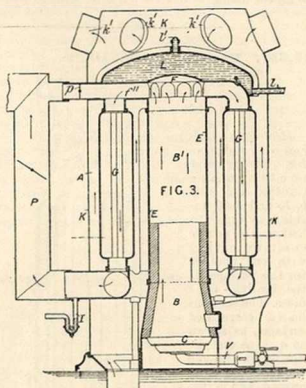

auxiliary pipe f¹, controlled by a damper p, opening into the main flue P. A seal pipe I traps any condensed steam which may be formed in the flues. In a modified arrangement, the water boiler is dispensed with.

19,613. Stanton, I., and Simmons, W. Oct. 16.

Bed-warmer and footwarmer.—The warmer A is of the ordinary shape with a funnel top B and screw-stopper C, for convenience of filling with hot water. There is a second screw stopper D for emptying the warmer, while the handle G is made in two parts E, F, the part F being detached when the apparatus is used as a carriage foot warmer.

**19,696. Brophy, M. M.** Oct. 16.

Thermostat.—Relates to means for regulating the supply of heating fluid to boilers and water-heaters. The apparatus consists of a vessel a connected to the flow and return pipes f, g, so that water circulates through the pipes c and end compartments d, h, i, thereby heating and causing to expand the water contained within the closed casing a. The water presses the plunger l out against the spring m and closes the admission valve n by means of the handle o, cutting off the

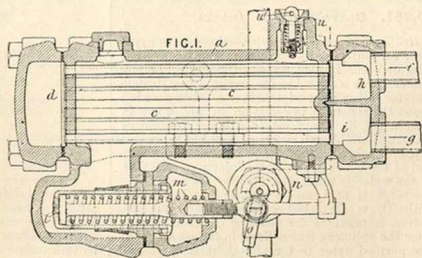

supply of heating fluid. As the water contracts the plunger *l* is pushed back by the spring *m*, and the valve *n* again opens, and an automatic regulation of the heating fluid is thus effected. To avoid excessive pressures in the casing *a* there is a relief valve *u*, which can be lifted by the orifice *u'* to fill the casing.

19,697. Brophy, M. M. Oct. 16.

Heating buildings etc., radiators for. The radiator sections are threaded on bolts *b, b*, and held together by nuts, the hollow bosses *c* communicating with one another for the passage of the heating - medium. The sections have corrugated surfaces, as shown at *a, h*, so that air flowing in through the pipe *l* circulates around, and is prevented from escaping except at the top by means of the casing *m* and the cemented joints *h'*. The flat valve *m* is controlled by a suitable rod and frictional catch, and a hinged cover *i* protects the top of the apparatus.

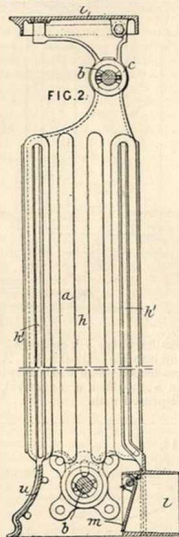

20,351. Carroll, J. E. Oct. 24.

Heating and purifying water.—Consists in apparatus for purifying water by causing it to deposit salts or other foreign matter it contains, hereby rendering it serviceable for use in steam boilers and for other industrial purposes. The drawing shows the apparatus in elevation in Fig. 2 and in plan in Fig. 3, as applied to a boiler of ordinary construction. A series of parallel tubes *B* connect a pair of tubes *C, C'* arranged transversely at each end of the boiler. The water inlet pipe is at *D*. If the water is solely for feeding the boiler, the discharge is at *I*, and a pipe *H*, which, together with *D*, is furnished with suitable controlling valves, is provided for blowing out from time to time the sediment that collects in the pipes *B*. If the purified water is for storage it is conducted

away by a pipe *L*, through which, in that case, the blowing off may also take place.

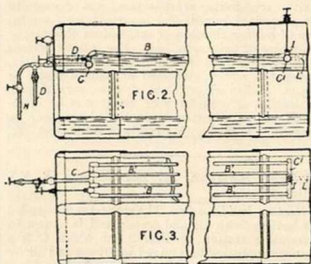

20,370. Herendeen, E. W. Oct. 24.

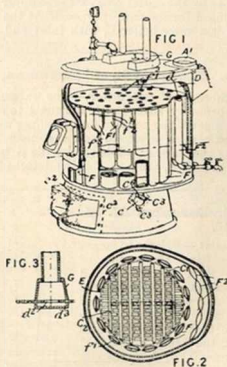

Heating buildings, boilers for. Relates to apparatus for heating buildings by hot water. The combustion chamber *E* is surrounded by tubes *F* with partitions *f'* which extend nearly to the bottom ends. At the uptake side, the edges of

these tubes are arranged closely, but on the opposite side spaces are left as shown in Fig. 2. A number of cut outs f^2 , of varying depth, are also provided. Short tubes F^1 with diaphragms f^3 , are arranged above E and screw into the tube plate d , terminating at f^2 . In the uptake area, a set of tubes F^2 somewhat shorter than the tubes F are arranged as baffles, and through which the return water from the heating system returns to the boiler. The hot water is taken from the central area, a divisional plate being fitted corresponding to the diaphragm plates in the tubes to prevent mingling with the return water and to promote circulation. A number of hot water domes, such as D, may be arranged to lead to a common delivery dome.

20,506. Kitson, J. W. Oct. 26.

Non-conducting coverings.—The non-conducting composition is contained in two or more segments c of suitable form, and these are kept in position by a metal band e having a loop f , through which the end is inserted and bent back, to hold the segments tightly against the pipe or other body to be protected.

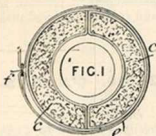
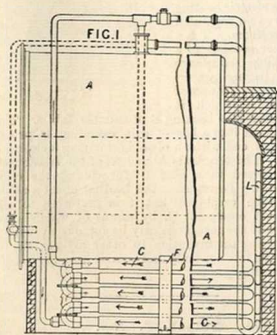
20,509. Hodgkinson, J. Oct. 26.

Heating water, boilers for. A vermiform appendage, opening into the boiler at different levels,

is provided in the furnace flues, the arrangement forming an auxiliary heater, an automatic water-circulator, superheater, and in some cases a transmitter of heat merely. As applied to an internally-flued boiler A, Fig. 1, the flattened coils C represent the water circulator, which draws its supply from the boiler or is provided with feed from external sources. The supports F of the coils are so arranged as to secure the elements of the coils between grips by the insertion of cottars. A settling-chamber, constructed with a mid-feather, may be also provided in connection with the system. Suitable jointing for the pipes is provided. In one case a screw union is formed with internal shoulders, against which the lengths of the piping abut when tightened up. Convenient valves regulate the respective flows. The auxiliary heater may form a closed circuit, one half of which traverses the water space of the boiler for transmitting heat thereto by the water circulating through the coils.

20,550. Wilson, H. M., [Langridge, J.]
Oct. 27.

Heating buildings &c.; steam trap; thermostat.—

Steam is supplied to the radiators in the various parts of a building or ship through the apparatus shown in section in Fig. 2, which regulates the supply of steam and allows the water of condensation to escape. Steam is supplied by a boiler through a pipe, not shown, and passes by the pipe G to the various radiators, the supply being automatically regulated by the valve F, carried by the valve-stem D^1 , which is made from an alloy having a high co-efficient of expansion, so that when it becomes heated by a too great supply of steam, it expands and closes the said valve. To increase the movement of the valve, it may be carried by a lever, to which the stem D^1 is jointed between the valve and the fulcrum. Any water of condensation in the heating system flows into the vessel A and lifts the float D. The outlet valve E is thus opened to allow the water to escape, while the valve F is closed to prevent the escape of steam from the heating system. The valve-seating E^1 is

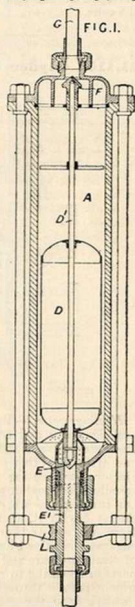

screwed into the crosshead L so that it can be adjusted. The apparatus shown may itself be used as a radiator.

keep the valves tight when the apparatus is not at work. To open b and c together, the collar a' must be shifted on the spindle.

20,805. Shulver, A., Self, J., and Constance, G. Oct. 30.

Boiling pans.—Kettles, stewpans, coppers, and other vessels for boiling liquids are constructed with a bevelled flange b, having a flat seating c, on which a hollow cone d is placed when it is desired to boil milk without it boiling over. The milk passes up the cone through the tube f, falls over the cooling surface g, and returns to the saucpan &c. through openings h at the bottom of the cone.

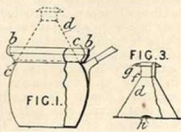

21,477. Preston, R., and Thornley, T. Nov. 8.

Boiling pans, paper-pulp digesters, &c. are lined with a cement consisting preferably of 20 parts of asbestos, 10 parts of litharge, and 70 parts of crushed slag. The crushed slag, or its equivalent in sand, may be omitted, and a suitable quantity of sulphate of lime or of barium may be added. The dry ingredients are ground and made into a pasty mass by means of a solution of silicate of soda or potash of a strength of 100° to 120° Twaddell. The composition may be applied in two or more coats like builders' plaster, or it may be used for embedding in position lining bricks or tiles &c., and for pointing and making joints.

21,110. Glydon, G. Nov. 3.

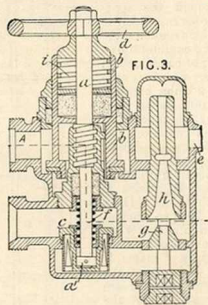

Heating water.—Relates to ejectors used for heating water and consists of means for opening the water valve b and steam valve c together, or one after the other. The apparatus shown is an ejector for heating water. In the Figure the spindle is screwed down and the two valves closed. On turning the wheel d, the spindle a rises and carries b with it, thereby allowing water to pass from A to e. As the spindle rises, the projection a' engages the valve c and lifts it against the action of steam pressure and a spring f. The valve c has ports in its casing to regulate the supply of steam, which passes through g and forces the water through h to the outlet e. The springs i and f

21,549. O'Neill, H. G., and Jewell, E. Nov. 8.

Heating by electricity.—Relates to electrically heated robes, towels, quilts, bandages, and other articles of flexible fabric, for applying heat to the body. By way of example, Fig. 2 shows a towel, and Fig. 3 the electric heating device separated therefrom. The latter consists of a flexible resistance A, having waterproof and fireproof coatings, which is secured by a backing B of suitable fabric. This is inserted into a bag of soft towelling D, provided at one end with an opening d having a closing flap D'. The terminals A' and A'' of the resistance are connected to a plug B' for closing the electric circuit. To regulate the heating effect a rheostat may be employed, but it is preferred to use a branch conductor C, by means of which a good part of the resistance may be cut out at will. In applying the invention to other articles, the form of the interior body and outside case are modified accordingly.

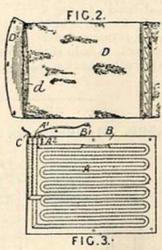

21,571. Geipel, W. Nov. 9.

Steam traps.—Relates to improvements in steam traps of the type described in Specifications No. 1876, A.D. 1871, No. 7860, A.D. 1893, and No. 995, A.D. 1884. Instead of screwing the

valve spindle *a* to the bracket *b*, it passes freely through the hole *c*, and is surrounded by a coiled spring *d* limited by collars *f* and *g*, so that normally the valve is open, as shown by Fig. 1^a. Upon steam blowing through the discharge pipe *h*, the unequal expansion of the pipe *h* and rod *i* brings the valve seating on to the valve and closes the outlet, while if any further expansion takes place the valve stem compresses the spring and no injury is caused. In modified arrangements, a pivoted lever is interposed between the spring and valve spindle.

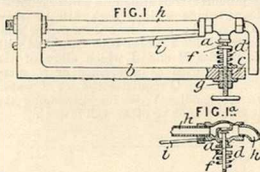

21,697. Hadfield, T. Nov. 10.

Heating air and other gases.—Relates to gas stoves for heating purposes. The invention is shown in vertical section in Fig. 3. The combustion chamber *B* is fitted into a case *A*, and contains in its floor three atmospheric gas burners *E*, the nozzle *E*², and the opening *E*³, of the mixing chamber, being coned as shown in the Figure. The products of combustion pass through the opening *B*¹ to the chamber *F*, which contains a baffle plate *F*¹ to cause circulation of the gases round the walls of the chamber, from which they finally issue through the flue *K*. Cold air, entering by the tube *I*¹ through which the flue *K* passes, traverses the heating chambers *P*, *Q*, which surround the combustion chamber and then pass around the outside of the chamber *F*, issuing through perforations *J*¹ at the top of the stove. The door *D* of the combustion chamber is provided with panels of glass, mica, or other transparent material

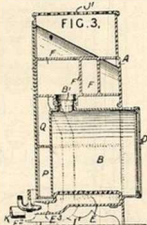

gases and products of combustion from which, after circulating around the boiler, escape by the outlet flues *A*, *B*. The boiler is especially adapted for heating greenhouses and the like.

21,819. Roberts, R. E. Nov. 12.

Heating water for baths &c. A coil of piping *a* is arranged in the fire-grate of the stove or fire place, and connected by flow and return pipes *c*, *d* with the hot water system, so that the water entering the coil by the pipe *c* is heated by the fuel contained within the coil *a* and led away by the pipe *d* for use in baths and the like. A short vertical pipe fitted to the inflow pipe serves to collect sediment, and the front portions of the coil *a* may be utilised as fire-bars.

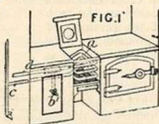

21,841. Willis, P. R. J., [La Londe, J.], Nov. 12.

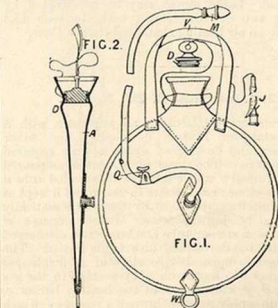

Hot water bottles &c.—The apparatus is a combination hot water bottle, water-cushion, syringe,

21,781. Quadling, G. Nov. 12.

Heating water.—Relates to heating water boilers of the type shown by Fig. 1, in which *E* is the outer and *G* the inner shell of the boiler furnished with inlet and outlet pipes *D*, *C* respectively. The boiler is supported on a distance piece *H*, *H*¹ provided with an orifice *R* for the insertion of a lamp or gas burner, the hot

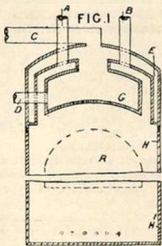

and spray producer, consisting of a rubber or other receptacle A having a filling neck with a screw stopper D. At the side there is a screw connection on which fits a rubber tube furnished with removable nozzles M and J which allow of the apparatus being used as a syringe or a spray producer. A clamp Q regulates the jet of water, and there are handles V, W for suspending the apparatus from a hook or other wall fastening.

21,971. Shorland, E. H. Nov. 14.

Heating air and other gases.—Stoves or fireplaces are

constructed with air heating chambers at the back and sides communicating with arched or cross chambers placed in the path of the products of combustion. The back chamber *f* is provided with gills or plates *g*, and air entering the chamber *k* passes between these gills on its way to the branched cross tube *b*², which conveys it to the outlets *i*. The side chambers are indicated by dotted lines in Fig. 2, and contain baffle plates or gills for the purpose of more completely heating the air in its passage to the cross tubes *b*, *b*¹ which are also provided with plates or gills both externally and internally. The grate *a* is arched, and also slopes downwards towards the front, the grate surface being thereby increased. Large stoves may be constructed by placing two or four stoves back to back and forming an air heating chamber between them.

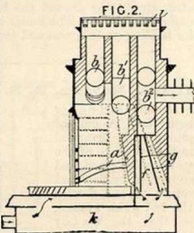

22,013. Hearson, C. E. Nov. 14.

Thermostats.—Relates to an apparatus with a thermostat for heating developing and other solutions and developing dishes to any required temperature. The developing solution is poured into a funnel *f* and circulates in a coiled tube *d* which is immersed in water in the vessel *a* kept at the required temperature by the thermostatically regulated heating apparatus. Water entering at *e*¹ circulates in similar tube *e*, whence it is discharged at *e*² into the developing dish to be heated. The thermostatic apparatus consists of a diaphragm valve *g*, *g*¹ which controls a by-passage in the gas pipe *j*, *g*², *g*³ which supplies the heating burner *g*, the main supply passing through a passage *o*¹ which is controlled by a hand valve *p*. The valve *g*, *g*¹ is controlled by a flexible capsule *u* containing a

liquid which boils at the required temperature, and acts on the valve through the rod *x*, the

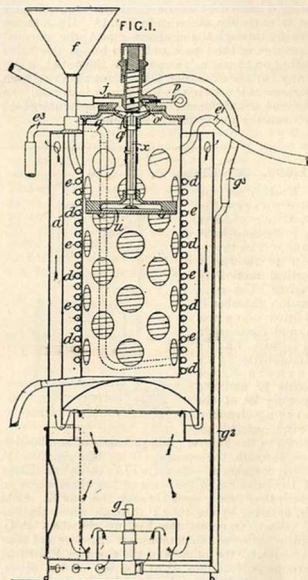

capsule *u* being immersed in the liquid contained in the vessel *a*.

22,059. Brook, H., Watson, H., and Hardcastle, J. Nov. 15.

Heating buildings

etc.—Relates to pipes for heating apparatus, which are fluted after the manner shown by Figs. 5 and 8, so that their radiating power is increased, while their sectional area is diminished. The pipe joints may be of the ordinary spigot and socket type or other well known form.

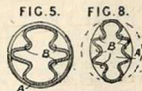

22,597. Nightingale, E. Nov. 22.

Steam traps.—The condensed water is first led into the chamber *f*, in order that it may deposit foreign matter held in suspension, and afterwards it passes through the bore of a perforated pipe *a* past the valve *e*² into the stem *g* and hollow float *f*, finally passing into the casing *c*. As soon as steam begins to enter, it forces out the water contained in the float *f*, causing this latter to rise and throw the links *d*, connecting the pivoted valve collar *e* and an adjustably fixed collar *b*¹, into a position at an angle with the axial line of the pipe *a*, thereby forcing the valve stem *e*² on its seat and shutting off the steam. To prevent air from closing the valve, there is a conical valve *h* regulated by a spring for permitting the escape of air into the casing without raising the float.

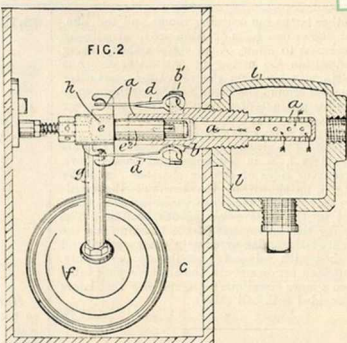
**22,965A. Thompson, P.**, [Coffin, C. L.]
Nov. 21.

Heating by electricity.—Metal or other conducting bodies are heated by bringing the metal &c. into circuit with a liquid electrode containing a substance more volatile than water, which volatile constituent is inflammable. In the Figure, a rivet *Z*¹ is placed in a bridge piece *Z*² connected to one pole of a generator and its end is immersed in a liquid *Z*¹ contained in a vessel *Z* connected to the other pole of the generator.

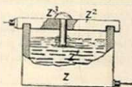
**23,055. Christmas, C.** Nov. 28. *Drawings to Specification.*

Heating water, boilers for. Consists in the addition to boilers of looped water-tubes depending into the flues. To secure the tubes to curved plates of the flues, a suitably shaped washer is placed on each side of the flueplate about the end of each tube in order to form level bearing surfaces for screwed nuts securing the tubes in position.

23,095. Kite, C. F. Nov. 28.

Heating buildings &c.—The radiator sections are corrugated, as shown in cross section by Fig. 3, thereby increasing their heating and radiating power. Each radiator is provided with the usual

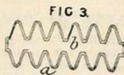

regulating valves, and two or more may be coupled together so that the hollow spaces between the corrugations form flues for heating the air which may be admitted through hand operated slide valves and permitted to circulate between the radiators, thereby heating and ventilating the apartment.

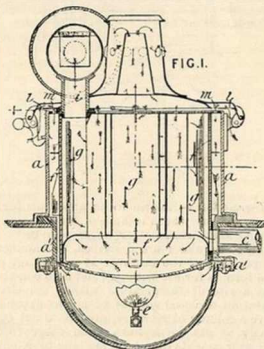
23,142. Sykes, T. Nov. 29.

Heating by air circulation.—Relates to means and apparatus for utilizing the heat from gas, oil,

and other lamps for warming rooms and the like. Fig. 1 shows one form of lamp provided with an extension a' to allow of an air chamber f being placed within the casing a ; this latter casing is supplied with air from the ventilator i , and after circulating around the tubes g made for the passage of the hot products of combustion from the burner a it escapes by the outflow pipe c into the compartment or room which it is desired to heat and ventilate. The air supply for the burner e enters the orifices l, m in the cover and passes down between the sides of the air chamber f and the casing a , as shown by the arrows; the ventilators may be furnished with vanes to enable them to set in the most advantageous position. The pipes for the conveyance of the hot air from the lamp are rectangular or oval in cross section, and furnished with valves for regulating the supply. In modified arrangements, the air conveying tubes pursue a more circuitous path, and the ventilators are provided with ball valves.

23,179. Lake, H. H., [Lion, A.]. Nov. 29.

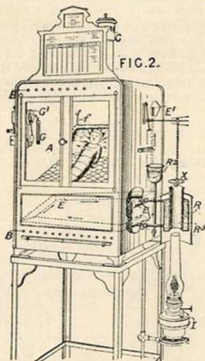

Thermostats.—Relates to an apparatus for rearing prematurely born infants, or for hatching eggs, rearing silkworms, or for other purposes. Two forms of regulator are described, to maintain the temperature of the chamber at a constant point. One form is for use with gas, and is so constructed that a rise of temperature within the chamber causes an enclosed volume of air to expand and drive a column of mercury upward to cut off the supply of gas for a time. The other form of regulator consists of a bent metallic tube, one end of which is fixed and the other end of which is connected to a pivoted lever, from which is suspended the damper X for opening and closing the central flue R^3 of the boiler R .

23,191. Grummitt, J. Nov. 29.

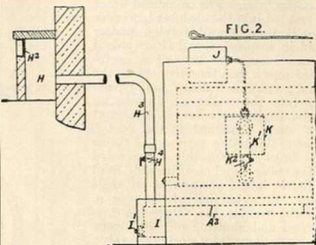

Heating water; boilers; water supply.—In order to prevent incrustation and corrosion in heating water boilers of the saddle type, the water is drawn from the cistern J into an intermediate receiver K , where it mingles with hot water issuing from the boiler by means of the pipe K^1 , the result being that most of the impurities in the feed are deposited in the receiver K and drawn off by means of the cock K^2 . The air for combustion in the grate is drawn into the chamber H through the perforated grating H^1 , and passes by the pipe H^2 into the chamber I and flues A^2 . A cleaning door I^1 is provided, and the air supply is regulated by the valve H^3 .

23,298. Saville, C. Dec. 1.

Heating water.—A method of heating water in a tank A consists in passing steam through the coil B , which, after circulating therethrough, is discharged by the perforated pipe E and condensed. Cold water is led into the tank by the pipe G , and is drawn off by means of the pipe H .

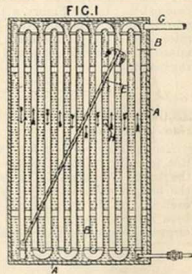

23,569. Jackson, W. Dec. 4.

Heating air.—A chamber E , in which tea, coffee, grain, &c. are dried, is heated by hot air supplied from the tubes a , around which the hot gases from the fire circulate. The tubes are in sets, opening alternately into the air on the two sides of the furnace, the other ends opening into chambers d

communicating with the drying chamber. Similarly arranged chambers opening at *i* are formed in the

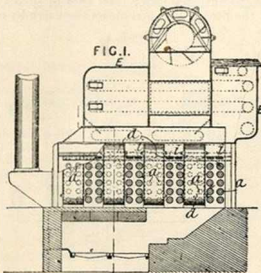

roof of the furnace, which also supply hot air to the drying chamber.

23,689. Read, H. P. Dec. 5.

Heating water. sectional boilers for. The water boxes *b*¹, *b*², *b*³, *b*⁴ are connected by tubes *a*¹, *a*², *a*³, *a*⁴ such that water entering by the inlet pipe *E* circulates through the tubes *a*¹ and *a*², then rising into the water box *b*¹, it enters the system of tubes *a*³, finally escaping into the water box *b*⁴ in a highly heated condition, from whence it is led away by the outflow pipe *F*. The furnace is of the ordinary type, and the back plates *c*¹, *c*², *c*³, *c*⁴ of the water boxes are made detachable in order that the tubes may be easily packed. The packing for the pipes

is of any ordinary kind and is secured in annular or conical recesses in the tube plate.

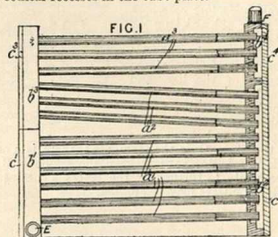

23,697. Woakes, A. B. Dec. 6.

Heating water.—Relates to improvements in apparatus of the class described in Specifications No. 259, A.D. 1892, and No. 11,749, A.D. 1893.

Electrodes for use in heating water are constructed of a pair of concentric platinum tubes *i*, *j* coated with enamel *a*, *a*¹ and perforated by orifices *h*, so that water or other liquid can circulate in the annular space *g* and so make a circuit for the passage of an electric current through the liquid, which thereby becomes heated. The apparatus is inserted in a glass tube holder *b*, through which the leads pass and are connected up by suitable contact devices. In modified arrangements, the electrodes are flat and are contained in suitable holders or grids.

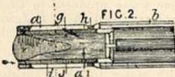

23,758. Wright, S. H. Dec. 7.

Churning air.—Relates to means for churning cream by means of a current of air, the temperature of which is regulated in a special manner. In the Figure *h* represents the vessel in which the cream is churned. The vessel *h* is fitted with a lid *i*, with a pipe *j* leading to a suitable exhaust pump, and also with a perforated pipe *k* connected by the pipe *d* to the vessel in which the air is heated or cooled. The said vessel is formed with double walls *b* and *b*¹, and is fitted with a cover *c* having a depending flange *c*¹ which fits between the walls *b* and *b*¹. Perforations *b*², *b*³ are made in the said walls to allow the current of air to pass through the apparatus, as shown by the arrows. A jar *a*, containing the cream to be churned, is placed inside the vessel *b*, *b*¹. The vessel *b*, *b*¹, which is preferably made of porous earthenware, is filled with hot or cold water until the cream in the vessel *a* and the vessel *b*, *b*¹ itself is of the desired temperature. The water is then drawn off from the vessel *b*, *b*¹ and the tap *g* closed, and a given quantity of cream drawn from the vessel *a* into the churning vessel *h*. The tap *g* is then opened and air is drawn through the vessel *b*, *b*¹ into the vessel *h* until the churning is completed.

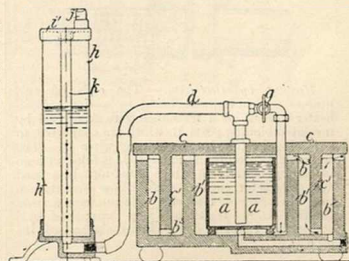

23,902. Simon, S. Dec. 8.

Non-conducting coverings.

—Upon a backing of asbestos cloth A there are attached a series of flat segments B of fibrous loose asbestos or the like, and formed slightly wedge-shaped to permit of the finished covering being wrapped round steam pipes and the like. Over the segments C there is a network of asbestos yarn to keep the segments B in place, while, to further fix the layers, a coating of a soluble silicate may be applied.

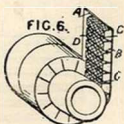

24,199. Fisher, J. A. Dec. 12.

Non-conducting compositions.—A mixture in various proportions is made of the precipitated lime waste produced in Clarke's water softening process, fossil meal (infusoria), and quicklime, while flour is added to render the mass adhesive and asbestos fibre to give it the requisite coherency and toughness. The composition is mixed with water to the consistence of mortar and plastered upon the surface to be coated.

24,510. Davidson, S. C. Dec. 17.

Heating air.—Air is heated by drawing it through a chamber through which pipes carrying exhaust steam pass. The steam expands in a chamber at the top of the pipes and another chamber at the bottom receives the water of condensation.

24,583. Whittingham, G. H. Dec. 18.

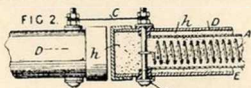

Heating by electricity.—The ends of two heaters are shown, one being in section. Each heater consists of a resistance wire A, carried by insulated binding posts B which are connected to adjoining heaters by conducting wires C. The surrounding iron radiating pipe D is filled with an insulating material h which must also be a good heat conductor, such as sand. As a precaution, a tube E of glass or mica separates the wire A from the tube D, but the tube E may be replaced by a coating of enamel on the inner surface of the pipe D.

24,650. Beech, E. W. Dec. 18.

Heating water; boilers; valves and cocks.—Within the casing A hot water circulates from the

flow and return pipes T and W of the boiler and forces its way past the valve L into the inner casing B until the water level rises to such a point that the float Q lifts and closes the valve by means

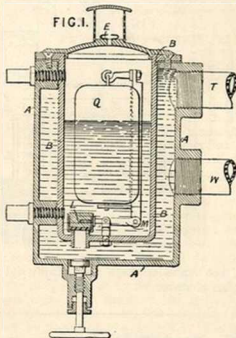

of the lever M. The float Q is so arranged that if the normal pressure is exceeded the steam in the casing A lifts the valve and escapes through the orifice of the whistle E, whereby the pressure is relieved and an alarm is raised.

24,852. Scholz, O.
Dec. 21.

Heating air.—Relates to an inlet ventilator adapted to heat the incoming air, placed near the floor, and a plain outlet ventilator placed near the ceiling. The inlet ventilator, Fig. 1, has a number of vertical cross tubes d through which hot air passes from a lamp b and escapes into the outer air by a pipe h. The ventilator is fitted with a sliding door or valve e, to close the inlet after the room is sufficiently heated. The incoming air is heated by passing between the hot tubes. The

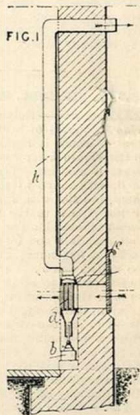

air rises after entering the room and escapes by a plain outlet ventilator near the ceiling at the opposite side of the room. The system is specially applicable to restaurants.

25,021. Naylor, S. Dec. 24.

Heating buildings &c.—Relates to water heating and circulating apparatus in connection with domestic fireplaces, and consists of a tube formed either by coring out the interior of a cast iron block, or by casting a block of iron about a

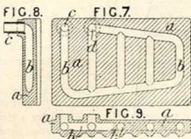

separate iron or copper tube bent to required shape. In Figs. 7, 8, and 9 are shown three sectional views of a boiler constructed by coring out the interior of a cast iron block *a*; *c* being the inlet and *d* the outlet pipe. Instead of employing the vertical tubes shown in Fig. 7, the tube *b* may be formed as a continuous zigzag. The front of the block *a* is ribbed to promote absorption of heat from the fire, and when a tube is cast into the block it is left partly exposed at the back to minimise the danger of an explosion.

25,252. Williams, J. H. Dec. 29. *Drawings to Specification.*

Heating water, boilers for.—In connection with the settings of steam generators, instead of employing brickwork, water chambers are employed from which hot water may be drawn as desired.

A.D. 1895.

85. Prew, E.
Jan. 1.

Heating air; heat buildings.—Relates to means for warming the air of rooms, conservatories, and the like by means of a U-tube *P* let into the flue *c*² of a fire-grate *F*. The hot products of combustion by circulating round the U-tube, heat the air which enters by the inlet *p*³ and escapes by the *p*⁴.

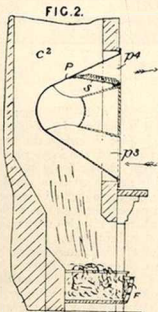

91. Baker, W. J.
Jan. 1.

Heating and purifying water.—Consists in apparatus for separating lubricating and other greases from the exhaust steam of steam engines and for condensing and utilizing the cleansed steam, or pure live steam, for heating and purifying water for boiler feed and other uses. In the Figure, *A* is the grease separating chamber into which the exhaust enters at *F*; *B* is the heating chamber, in which the

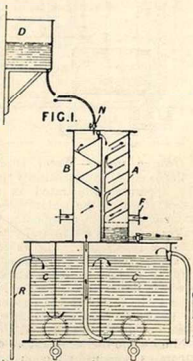

cleansed exhaust meets a spray of the incoming feed water at N, and in which a stream of the precipitating reagent supplied from the tank D mingles therewith. Beneath is the settling tank C, C, in which lime or other sediment is deposited, and wherefrom the purified water may be drawn off through the pipe R. A modified form of the separating and heating chambers is also described in the Specification. Draw-off cocks, baffles, hand holes, and other usual fittings are provided.

477. Taylor, W. H. Jan. 8.

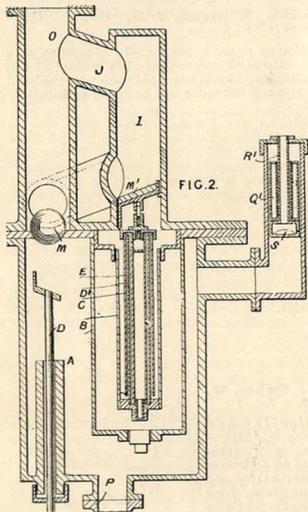

Heating water.—Water supply to or from a boiler is cut off automatically in frosty weather by the apparatus illustrated in section, when the temperature of the water falls sufficiently. The water passes from an opening O to an opening P, unless cut off by a spherical valve M resting in the position illustrated. The valve M may be raised by a hand rod D, to open the supply, and then falls through an opening J upon a support M'. If this is where illustrated, the valve M returns by a side tube to its seat, but the support M' may be held up by the thermal expansion of a suitable liquid contained in a vessel A, and the valve M is then held up while the temperature of the water in the apparatus remains high enough. For this purpose,

the support M' rests on a tube C and float E, which slides in a fixed casing B, provided with an inner tube D'. Mercury is placed between the casing B and tube D', to separate the water between the tubes B, C from the expandible liquid between the tube D' and float E. Such apparatus may be placed just below a supply cistern at the highest point of a system, and provided with a valve S to admit air to the pipes when water is drawn from them after the valve M has closed. Valve S is carried by a float Q', and closes the lower end of an open tube R', when raised by water in the apparatus. When open it permits steam to escape. Another apparatus is specified for automatically stopping the water supply to or from a boiler after any stoppage in the supply, until it is opened by hand. It is similar to the apparatus illustrated, excepting that the support M' is carried by a float in the side tube I, instead of the thermal apparatus. It is preferably placed near the boiler.

738. Siepermann, W., and Riegemann, H. Jan. 11.

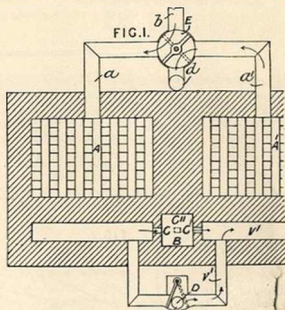

Heating air.—The apparatus is shown in sectional elevation by Fig. 1. The air from the supply pipe *b* enters the regenerative chamber A by means of the inlet pipe *a* and escapes below through the orifice *c* into the chamber B. The highly heated air then divides, one portion passing through the outlet *c'* for use, whilst the other portion passes through the passage *c'* into the chamber V' where it mingles with waste gases from furnaces coming through the passage *c'* and passes into the chamber A', thereby highly heating the latter; the waste gases escape finally by the outlet pipes *a', d'*, as shown by arrows. When the valves *E* and *d* are thrown over, the air to be heated passes through the chamber A' while the waste gases pass through the chamber A.

743. Greenwood, W. W. Jan. 11.

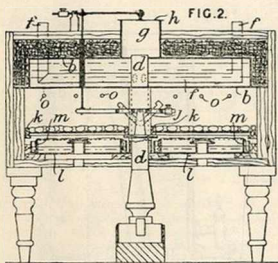

Thermostats for incubators. The machine is heated by means of a hot-water tank *b*, through which passes a central flue *d* from which radiate four flues *f*, *f* which pass, respectively to the four corners of the tank. The top of the flue *d* leads into a chamber *g* closed by a damper *h* operated by any suitable thermostat such as a bent tube *j* filled with ether and mercury and connected by suitable mechanism to the said damper *h*.

747. Shydecker, E., and Brown, H. S. Jan. 11. Drawings to Specification.

Heating by electricity.—To assist in the heating of a multitubular steam generator, resistance coils through which electricity is passed are placed within tubes traversing the boiler water-space. The coils are surrounded by any suitable heat-diffusing medium.

Major, C. Jan. 16.

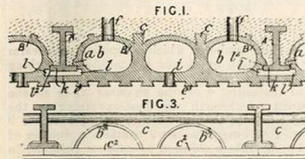

Heating buildings &c.—Fireproof lintels or blocks *B*, Fig. 1, are formed with transverse passages *b* which come into line when the blocks are laid in position, and may be used for conveying hot or cold air. Openings *f*, *i* are provided in the floor and ceiling for the purpose of putting the rooms in communication with the flues. Fig. 3

shows a modified form of block having flanges *c*, and tubes or flues *b* projecting on each side of a central web *C*.

1129. Milan, F. Jan. 17.

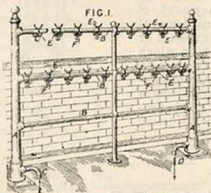

Heating buildings &c.—Racks formed of tubular metal uprights *A* and cross tubes *B* are provided with hooks *E* and number tablets *F*; hot air, water, steam, &c. enters at *C* and circulates through *A* and *B* and leaves at *D*, thus drying wet clothes hung on the hook *E*. Fig. 2 shows an ordinary heat radiator with hooks *E* for hanging cloaks &c. on.

1370. Beszant, E. N. Jan. 21. Drawings to Specification.

Heating water, coil for. In order to heat water for domestic use, a coil of pipe is placed in the chimney flue of an ordinary grate connected by flow and return pipes to a cylinder attached to the ordinary boiler. As the hot air and gases circulate around the coil the water is heated, and with the arrangement described the risk of explosion through the formation of steam is much lessened.

1960. Major, C. Jan. 28.

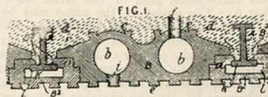

Heating buildings.—Passages *b* in flooring-blocks *B* communicate with the rooms above and below by means of apertures *f*, *i* in the floor and ceiling, and may be used for heating purposes.

2018. Davidson, F. A. L. Jan. 29.

Heat, utilizing solar.—Fig. 3 shows a cross-section of a signalling apparatus, which can be used as a cooking-stove. On the chimney-cowl *c* of the signal-lamp *C* is placed a mess-tin or other vessel, on which the sun's rays are focussed by a burning-glass *n*, carried by a support *k* and provided with adjusting screws.

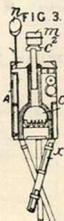

2380. Tatham, H. B. Feb. 2.

Heating water &c., boiler for. The apparatus consists of a boiler *B* heated by a lamp, and provided with suitable cold water inlet pipes *p*, *p'* and draw off cocks, *s*, *s'*, the lower one being intended for completely emptying the boiler, while a tube *t* prevents the water-level from rising too high. To the lower part of the boiler a central hollow disc *D* is attached by studs *a*, which form a means of communication with the boiler. This hollow disc serves as a deflector for the lamp flame, while the

flue *d* provides for the escape of the waste gases. A modified form of boiler of annular or sinuous

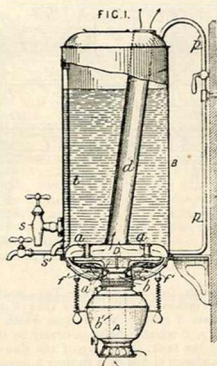

type may be used, and the lower depending portion may be formed as a truncated cone or as a coil of piping.

2429. Postle, J. D. Feb. 4.

Heating air.—Relates to processes and apparatus for thawing frozen meat and other frozen substances, and for warming and drying air, which apparatus, with the necessary modifications, may be used also for drying fruits, meats, and other food-stuffs, for drying timber or clothes, for evaporating and concentrating liquids, and, lastly, as a freezing chamber. The Figure shows one form of the apparatus. The materials to be treated are placed in the chamber 2, which is supplied with warm dry air by the means shown. These consist essentially of a pump or blower 1, a moisture-absorbing chamber 9, a moisture-condensing chamber 11, a heat-exchanging chamber 5, and a heating chamber 19. The air inlet of the pump 1 may be connected either to the outlet 4 of the chamber 2, or to the external atmosphere, and, in the latter case, either direct or through the heat-exchanger in the chamber 5. The outlet of the pump may be connected either to the moisture-absorbing chamber 9 or to the moisture-condensing chamber 11. The moisture-absorbing chamber 9 contains a number of perforated discs, mounted on a rotatable shaft, and dipping into a solution of calcium chloride, in which is immersed a cooling coil 32. From it the dried air passes into a filtering chamber 12 containing perforated plates 13, and thence into a purifying chamber 15 containing coarse charcoal. The latter chamber may, by means of the pipes 17 and 18, be placed in communication with either the chamber 5 or the chamber 19. In the chamber 2 there are rails 36, upon which the materials to be treated are suspended, and a perforated ceiling 37 and floor 38. A modified and more compact form of the apparatus is also described.

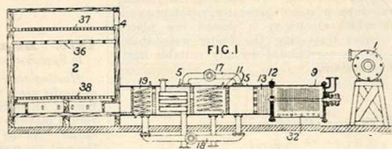

2723. **Eydman, F. H.** Feb. 7.

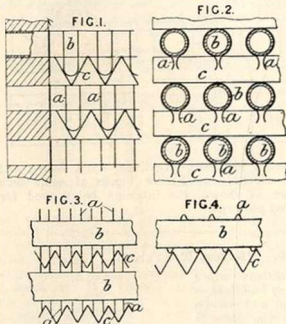

Heating by steam circulation.—In tubular apparatus loss of efficiency is caused by the formation of a film of water on the tubes due to condensation. According to this invention means are provided for removing such films by causing them to collect into drops which are directed into troughs by which they are conveyed away. In the arrangement shown in Figs. 1 and 2, loops of wire *a, a* are placed on the tubes *b, b*, so that their ends hang into troughs *c, c* which may be corrugations in a metal sheet. Or annular or helical flanges *a, a*, as shown in Figs. 3 and 4 respectively, may be employed, the said flanges dipping into troughs *c, c* as described above.

2826. **Seagrave, G., and Bevington, S. B.** Feb. 8.

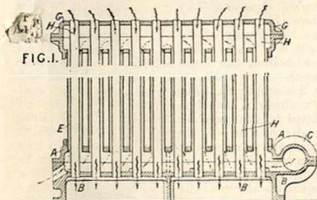

Heating air.—A method of heating air by exhaust steam consists in passing it through the inner tubes H of a radiator, while the exhaust steam entering by the inlet C circulates around the air tubes in the annular spaces between the tubes E and H. Both sets of tubes are fixed in flanged half-boxes or steam chests A, B, G, H, provided with suitable inlet and outlet passages and

baffle plates to guide the course of the steam. The heated air is drawn off by a fan and may be utilized for various purposes, such as for drying clothes, heating buildings, and the like.

2871. **Carron Co. and Bamforth, T.** Feb. 9.

Boiling pans.—Relates to steam jacketed boiling and cooking pans. The steam pipe A leads into an annular chamber B, from which pipes *b* provided with valves *b'* lead to the jackets of the various pans *c*. Above B is another annular vessel E, into which the water supply pipe F enters, and from which pipes *c* regulated by valves *c'* lead to the interiors of C. Branch pipes *g* lead from the pans C to an uptake G, whose lower end dips into a condensing pipe H, so that any matter carried with the steam falls into H and is carried off by a pipe I to the drain.

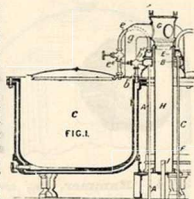

2381. **Bell, W.** Feb. 9.

Heating water, boilers for. The inner shell W of an annular boiler C has water-pockets or hollow baffle plates BP to cause the hot gases ascending from the pivoted gas burner GP to pursue a circuitous course and thereby more efficiently heat the water in the boiler before escaping through the chimney or flue F. An upper chamber CW receives condensation water from the flue F¹ and drains it away through the pipe CP. Suitable pipes WP are provided for the inlet and outlet of water.

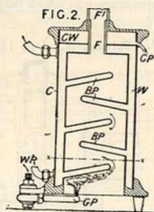

3203. **Wilson, M.** Feb. 14.

Heating water &c.—Relates to a method of preventing explosions in kitchen boilers and hot water cylinders. To the boiler &c. is fitted an elbow-pipe A, the upper end of which is closed by a valve H operated by a pivoted float I inside the boiler or cylinder, so that, should the water level fall through any cause, the valve H is opened to relieve the pressure. A gauge glass C, surrounding the elbow pipe A, D, shows the level of water inside the boiler, while the opening of the valve H

sets an electric bell ringing by means of the arm N and wire O. If the ordinary water-supply fails the boiler may be filled through the elbow-pipe E, A.

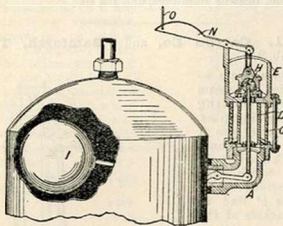

3271. Hammer, L., and Slama, E.
Feb. 14. *Drawings to Specification.*

Coverings and compositions, non-conductors of heat.—Boxes, bottles, jars, and like vessels, and plate or dish boxes or carriers are formed, by casting or pressure, of a non-conductor of heat, or the vessels, made of glass, metal, or other material, may be lined or covered with the non-conductor, or the parts of the vessels may be made with double walls, the non-conductor being placed in the spaces between, the construction serving in all cases to keep food stuffs and the like contents at the temperature at which they were placed in the vessels.

3407. Klein, J. Feb. 16.

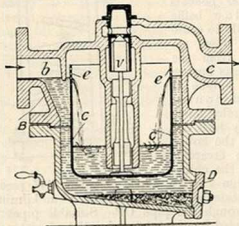

Steam trap.—Water of condensation flows into the trap casing B through the inlet *b*, and buoys up the hollow float C until the water rises sufficiently to flow through the perforations *e*, causing the float to sink and open the valve *v*. The steam pressure then forces the water away through the outlet *c*, thereby lightening the float C, which is again buoyed up, and by means of its attached valve closes the outlet. The sludge door D is so situated that cleaning can be effected without disconnection, while the arrangement of the valve box permits of the packing standing a high pressure.

3561. Kleine, J. F. Feb. 19.

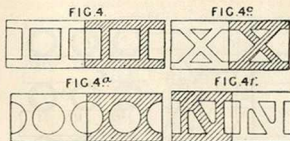

Heating buildings.—Ceilings, walls, floors, and roofs are built of hollow blocks of some such section as shown, the interiors being used for heating purposes.

3614. Pfister, T. Feb. 19.

Heating water; heating buildings.—In an oil lamp stove the flame is surrounded by an annular boiler, which takes the place of a chimney and provides a supply of hot water to a circulating system for warming green-houses and the like, J, J' being the outlet and return pipes respectively.

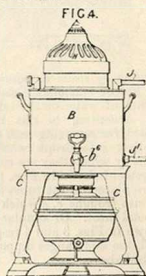

3850. Standing, W. Feb. 22.

Safety apparatus for boilers. To prevent accidents by bursting of domestic hot water and other boilers, the apparatus shown in section in Fig. 2 is employed. The screw threaded socket A is fitted to the boiler, or laterally to one of the circulation pipes. A copper tube B is of such strength as to burst if the pressure in the boiler rises dangerously, and the outer tube C conveys away the water and steam liberated in such case.

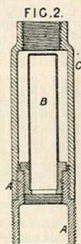

3870. Hopkinson, J. A. Feb. 22.

Heating water; heating buildings.—A hot-water supply apparatus is heated by an open boiler not

forming part of the circulatory system. In one form, a cylindrical water container A, furnished with a loosely-fitting lid a, encloses the circulator B, supported upon legs b' and provided with flow

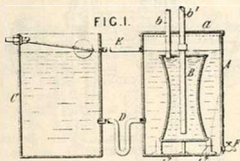

and return pipes *b, b'* to the circulating system, while a cistern *C* is connected to the container *A* by means of a syphon tube *D* below and a pipe or conduit *E* above, so that there is always sufficient water to cover the inner vessel *B*. The fire-boiler *A* forms part of a kitchen range or fireplace, and the heating of the water contained within it causes a circulation of water through the pipes *b, b'* and vessel *B* for heating buildings and the like, while the arrangements adopted prevent the formation of steam; by means of the tap *F* hot water can be drawn off for domestic use. Several modified forms of the inner vessel *B* are shown and described in which coiled tubes, corrugated cylinders, and the like are used.

4120. Meek, J. E. Feb. 26.

Heating by electricity.—Relates to a compound or mixed fabric consisting partly of metallic wires or strips, which are heated by the passage of a current. The fabric is applicable for making heating pads,

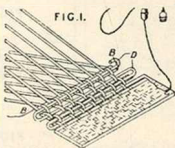

sheets, sweaters, and other wearing apparel, cushions, furniture coverings, curtains, table covers, carpets, rugs, mattresses, blankets &c. for heating the human body, railway cars, rooms, furniture, car seats, &c. Fig. 1 shows a piece of the completed fabric and the arrangement of the conductor *B* and non-conducting filling threads *D*, preferably of asbestos, which are woven together so that the conductor is wholly or partially embedded in the non-conducting portion, which preferably forms the warp of the fabric. The fabric may be covered with flannel, felt, plush, &c., which may be in the form of a removable sheath; or a waterproof coating may be used when intended for medical use. In a modification, the conductor may be placed between two layers of insulating material which are then stitched together. The fabric or casing may be treated with antiseptics and the threads or yarns may be waterproofed.

4133. Haden, P. Feb. 26.

Heating water &c.

—Relates to hot water systems for domestic supply and the like, in which the supply cistern *c* forms part of the circulating system, thereby preventing the freezing of the pipes. In the present system, the outflow pipe *e* is connected to the hot water tank *b* by the branch *e'* and to the cistern *c* by the branch *e''* containing a cut off tap *e'''*, while the pipe *e* is led into the cistern and terminates above it with an open end to prevent an excess of pressure. The descending main *d* connects both tanks with the boiler, and by suitably regulating the tap *e'''* a circulation of hot water is effected throughout the system and freezing is prevented. The supply pipe *f* runs parallel with the rising main *e* to prevent ice forming in it.

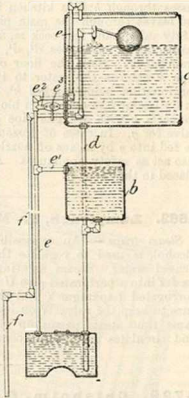

4262. Smith, J., and Stanfield, W. H. Feb. 27.

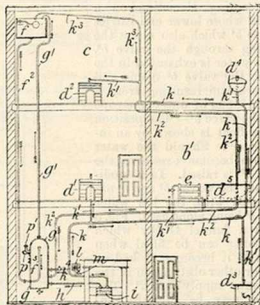

Heating buildings.—The Figure shows a system for heating a house and supplying hot water to baths, lavatories, and the like. The cistern *f*

supplies water to a cylinder *g* through pipes *f*², *f*³, the latter terminating in a perforated cap. Water passes through *h* to a kitchen boiler *i*, is heated, and leaves through the main pipe *k*, which has a safety valve *l* and test cock *m*, and supplies wash-basins *d*¹, *d*², lavatories *d*³, *d*⁴, and a bath *d*⁵ by branches *k*¹. Near the floor of the room *c*, the pipe *k* returns the water to the cylinder *g*, the continuation being marked *k*². A pipe *k*³ forms an outlet for *k* in event of a block, and a branch *k*⁴ connects *k* with *g*. The pipe *g*¹ acts as a safety valve for *g*. In cases of frozen pipes, water may be fed into *g* by means of nozzles *p*¹ and *p*², which also act as safety appliances. A heating coil *e* is placed in the room *b*.

filled with alcohol and connected to the valve *F*. As long as steam circulates in the casing the valve *W* closes the pipe *B*, and the expansible capsule 15

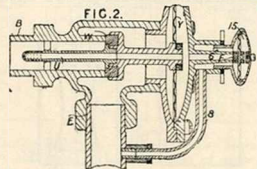

4662. Lamplough, F. March 5.

Steam traps.—An expansible liquid, such as alcohol, is used to regulate the outlet for condensed water. Steam entering by the inlet *B* passes into a perforated pipe *U* to the back of the corrugated diaphragm *Y* and thereby exerts pressure to keep the valve *W* on its seat, while at the same time steam passes up through the pipe *G* and circulates around the corrugated capsule 15

prevents escape of steam by means of the by-pass *S*, but as soon as water begins to collect the valve *W* is lifted from its seat by the diaphragm *Y* and a discharge of water takes place through the outlet *E*, while the by-pass *S* allows steam to escape from the back of the diaphragm. In modified arrangements, the diaphragm *Y* is either replaced by a piston or is wholly dispensed with, in which latter case the capsule 15 directly controls the valve *W*.

4729. Chisholm, G. March 6.

Heating water.—The invention relates in the first place to a safety valve shown in Fig. 5. A float *b* resting on a plate *b*¹ is raised by the water when the heating apparatus is in working order until the valve *b*² is closed. The valve *b*¹ has its seat within another valve *b*² kept on its seat by a spring *b*³ acting on a spindle, whose lower end carries a valve *b*⁴ which also closes the opening through the valve *b*¹. If the water is exhausted in the boiler, the valve *b*¹ opens and allows steam resulting from a sudden influx of water to escape past the valve *b*⁴. The position of the float is shown by an indicator *b*⁵. Should the water pressure become excessive the valve *b*² is raised. In a modification, the valves *b*¹ and *b*⁴ are dispensed with, the low water valve *b*¹ being alone used. Fig. 3 shows a funnel *C*² by which the boiler can be filled when access to it becomes choked by frost or other obstruction in the cold water supply pipe *d*³. The funnel may be directly connected to the above described safety appliance, or as shown to the hot water pipe *d*⁴ attached to which is the above described

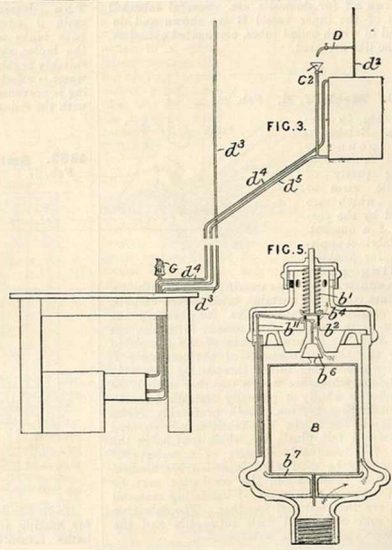

safety appliance shown at G. D is a discharge pipe connected to the hot water cistern vent pipe d' , and designed to prevent accident should the vent pipe become choked.

4831. Noble, K. D., and Irving, J. March 7.

Heating water.—The invention is illustrated as applied to steam generators, but may, equally well, be applied to other boilers. Fig. 2 shows a longitudinal section of one form of boiler in which two headers B, C are connected by water tubes A^1 , through which pass smaller smoke-tubes A^2 . Each header may consist of a plate folded as shown, or of two plates, flanged and riveted together. Over the front header is a steam and water drum D which is connected by tubes E to water-drums G below, communicating with the header C. The tubes E, backed by firebrick M, form the sides and back of the boiler casing and may have inside them smaller tubes through which the water passes downwards. The furnace gases pass upwards among the tubes A^1 from the furnace H and then rearwards and through the tubes A^2 to the uptake. Or, the gases may pass through tubes A^2 first and

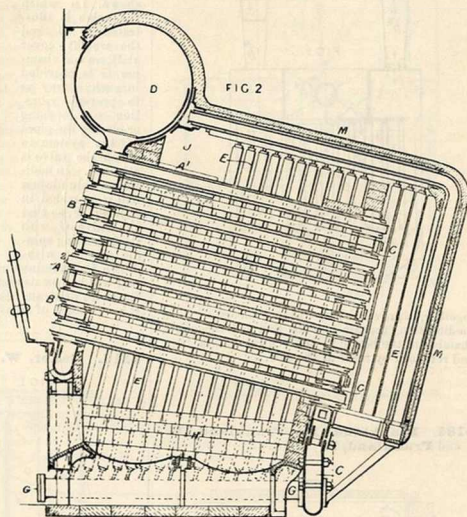

then around the outer tubes A^1 . In a modified form of boiler, a single transverse drum replaces the two longitudinal drums G, G, and a single longitudinal drum replaces the transverse steam drum D, the two being connected by tubes placed outside the fire-brick boiler casing. When inner tubes are placed in the circulation-tubes E, they are maintained concentric by distance pieces secured to them and may be flared at one or both ends.

5023. Joyce, H. W. March 9.

Heating air.—Relates to heating air for distribution in hop, malt, and other drying kilns and stores. For this purpose, air is passed in a tortuous manner through hollow firebars, from which the heated air is distributed as desired. Fig. 1 represents the firegrate in plan, part being shown in section, and Fig. 5 a sectional elevation on the line 4, 5, Fig. 1. Air, entering by the mouths b , passes from the boxes b^1 through the bars g^1 of rounded wedge-shaped section to the rear chamber b^2 , from which it returns by other inclined bars g^2

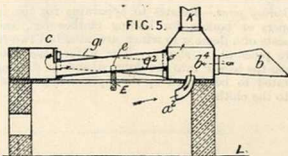

to the box b^4 , the heated air being then distributed by the conduit K. Air may be admitted direct to the box b^4 by the pipe a^2 , Fig. 5. A firebrar bearer E, made up of separate sections bolted

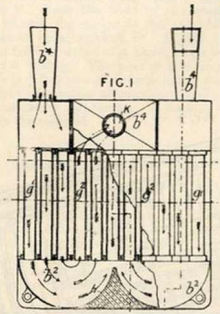

together, is provided with distance pieces e . In a modification, the air may be first led through a chamber in the box b^4 to the central hollow bars, and returned by those at the side.

5184. Frankland, H., Frankland, H., and Frankland, F. March 12.

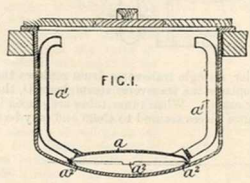

Boiling pans.—Relates to apparatus for use in coppers or boilers for boiling clothes &c., and consists of a dome a to which are attached two or more pipes a^1 , as shown. The water passes between the legs a^2 into the dome a , and on boiling is stated to be forced up the pipes a^1 to pour out on to the clothes.

5387. Waller, J. F. March 14.

Valves and cocks.
—Relates to a safety apparatus for boilers. In dead-weight safety valves of the form shown, in which the valve is illustrated at C and the weight cover at H, an air chamber G is provided in such a way as to prevent vibration on opening or closing the pipes of the system to which the valve is attached. In addition, an aluminium ball is provided in the cage F, so that the valve C with its depending spindle may be withdrawn for examination. On this taking place, the ball will bed on its seat and prevent the escape of the water or steam behind it. The seat of the valve C is composed of an asbestos compo washer.

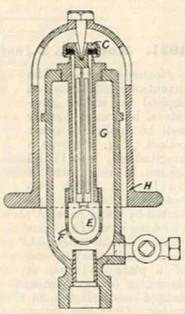

5516. Baker, W. J. March 15.

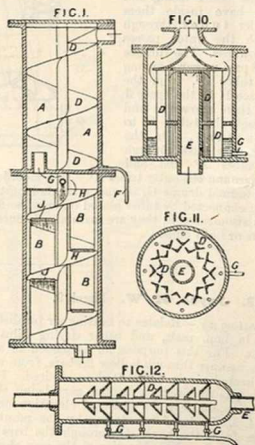

Heating water.—Relates to means for drying,

purifying, and condensing steam, and for heating and purifying water for boiler feed and other purposes. Several forms of apparatus are described in the Specification, of which typical examples are given above. In Fig. 1 is shown an apparatus for freeing exhaust steam from lubricating grease in the upper part A, and for utilizing the cleansed steam for heating feedwater in the lower part B. In each part the steam is caused to take a helical path by a web D, H. In the upper part are certain radial baffles, not seen in the Figure, and the oil and water deposited there are allowed to collect and are withdrawn by a pipe F. In the heater or condenser, as the case may be, a jet of water is introduced at G, and at various points in the helical web falls in a cascade through slits J. Fig. 10, with its section in Fig. 11, shows another construction of the grease and water separating apparatus, in which the steam is caused to impinge in the troughs of a number of angle-irons D on its way to the outlet pipe E. The inlet and outlet pipes, and the angle-irons, may be either vertical or horizontal and otherwise variously disposed. Fig. 12 shows a simpler form of similar apparatus in which a removable group of conical baffles are in the line of flow of the steam, and deposits are drained off by pipes G. A construction of ring-jet for feedwater heaters in two parts, so as to facilitate the drilling of the holes, is also described.

5561. Bruce, W. March 16.

Heating by air circulation.—A method and apparatus for heating consists in providing an apparatus of the type described in Specification No. 7978, A.D. 1894, in which a number of sections C connected below by a casing A have gas burners B,

the products of combustion from which circulate in the sections C and flues D, D', thereby heating the air flowing in from the shafts I past

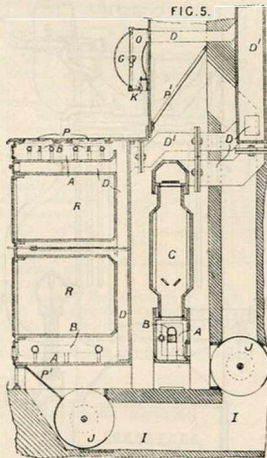

the valves J, J. The air for heating is purified before entering the room or apartment by passing through filter frames P¹.

5562. Crispin, J., Crispin, H. J., and Crispin, G. March 19.

Heating buildings.—In order to heat and ventilate rooms and the like, the spaces between successive pipes *a* of the heating coils are blocked up by means of strips *b* and kept in position by bolts *c* and nuts *c'*, so that a channel is formed for the air which enters through the grating *d* and passes up between the piping *a*, escaping at an outlet above into the room or apartment which it is desired to heat and ventilate. When the heating coils are vertical, the strips *b* at the rear are not carried down to the base, and those in the front are not carried to the top, whereby a channel is formed for the flow of air through the apparatus. In modified arrangements, the strips *b* are dispensed with and ribs cast upon the heating pipes themselves.

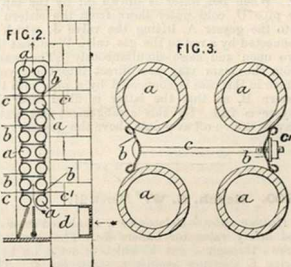

5746. **Forcher, E. A., and Winterflood, J.** March 19.

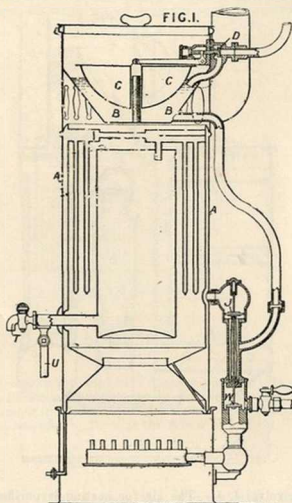

Geysers.—The geyser shown is supplied from a cistern B containing a float C which controls the water-supply from the main by means of a valve D. When hot water is drawn off by the tap T or pipe U, cold water flows from the cistern B into the geyser A, lifting the valve J, which is connected by a rod to the gas valve W so that the two open and close simultaneously. The water from the main may pass direct into the geyser, which in this case is connected by a pipe with the cistern B, so that the latter is filled after the geyser is full. By this arrangement hot water may be drawn off at points above the geyser.

5900. **Beech, E. W.** March 21.

Heating water.—Relates to a combined draw off and safety valve for boilers &c. The spindle H is raised through a nut F which is acted on by a spring E abutting against a screw cap C. The spindle is enclosed in a casing R, and it terminates in a head J which is hollowed out to receive the stem L of a valve K. The stem L is notched

enable it to be secured by a set-screw N, and the valve has feathers O engaging with notches in the head J and compelling the valve to turn with the spindle. Q is a drainage tube for water

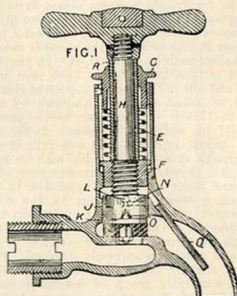

leaking past the head J. The valve can thus be raised either by the spindle or by excessive pressure. The spring may be contained in the head J, or weights may be used in place of the spring. An adjustable collar is sometimes used to prevent the spindle from being screwed down too far.

5981. **Naylor, S.** March 22.

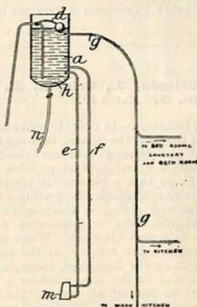

Heating water.—A system of heating water for house supply comprises an ordinary boiler m and an open hot water cylinder a, placed at the top of the house and connected to the boiler by means of



flow and return pipes *f* and *e*. The hot water supply pipe *g* is led away from near the top of the cylinder, while the cold water inlet pipe is controlled by a ball valve *d* and delivers the water at the bottom of the cylinder; a pipe *n* serves to convey away sediment collecting in the dish-shaped base *h*.

6181. Johnson, J. Y., [Morineau, A., and Blanc, C.] March 25.

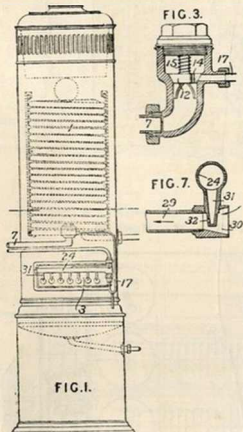

Heating water &c.—Fig. 1 is an elevation of a cylinder in which the water (or other liquid) is heated by a pipe 7 through a valve shown in detail in Fig. 3. When water is not being withdrawn from the heating-coil the valve 12 is held closed by the spring 15, equilibrium being maintained above and below by providing a perforation 14. When water is being drawn off, the valve is lifted and admits water to the coil and also to a small tube 17 which conveys it to the under side of a diaphragm or piston which operates a valve controlling the supply of gas to the stove 3. Thus, when water is being drawn off, gas is supplied to the stove and is ignited by a pilot jet, but when no water is passing through the heater the gas is cut off. A small tube removes the surplus water from below the said diaphragm or piston. The gas is supplied by a pipe 24, Fig. 7, from which depend short close-ended tubes 31 having perforations 32 directed into the perforated burner-tubes 29 which are closed at their inner ends. Air is drawn into the said burner tubes through the conical mouths 30.

6272. Seagrave, G., and Bevington, S. B. March 26.

Heating air and other gases for warming dormitories and buildings, disinfecting clothing, drying skins, clothes, and cereals. Consists of a number of removable sections with channels *B*, for the passage of the furnace gases to the uptake *C*, and channels *H*, so that air &c. entering at *I* passes out at *J* in a heated state. The firebars *D* are hollow, and oval in section, and a passage may also be made through the firebride to supply additional air. The furnace flues and the air conduits are arched. A suction fan may be fitted at *J*. When thin strata of air have to be heated, the depth of the passages *B* and *H* is decreased.

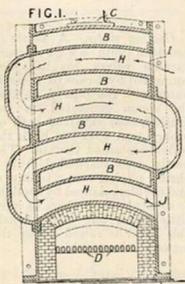

6396. Clayton, J. March 28.

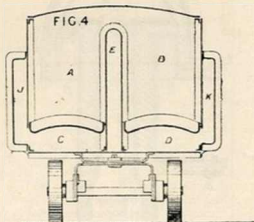

Boilers for tar, pitch, and the like are formed in two sections *A* and *B*, as shown in transverse section by Fig. 4, each section having separate heating furnaces *C*, *D* communicating with the central partition flue *E* and jacket flues *J*, *K*. The apparatus is provided with the usual doors and taps, and is mounted on wheels to render it portable, while the design provides that either section can be heated independently, and should one of the sections boil over the superfluous material flows over the partition *E* instead of running over the sides of the apparatus and being wasted.

6408. Walbrand-Evans, F. W. March 28.

Heating water.—A kettle *a*, provided with safety and vacuum valves, has its spout connected by means of a screw union with the pipe *j*, so that the steam generated in the kettle passes into the bath or other vessel *k*, and so heats the water contained therein. The kettle *a* is suspended from a chain *c* passing over a pulley *e*, and counterbalanced by a weight *f*, so that when there is very little water left in the kettle this latter is raised up by the action of the weight.

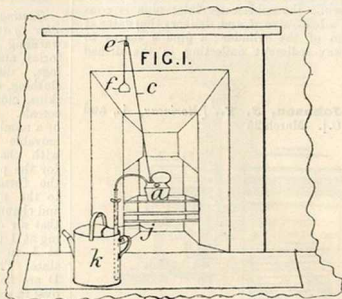

6535. Beck, F. W. March 30.

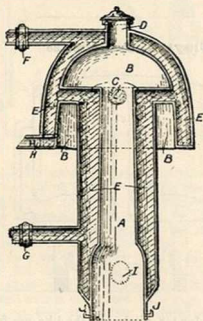

Heating water, boilers. The boiler is made in two parts or sections, the lower one consisting of two tubes, so joined as to form a water-container *E*, connected by three horizontal tubes *C* to the upper annular dome *B*. The inner tube *A* is made in the form of a lamp chimney to receive a lamp or other convenient heating apparatus, the lugs *J* serving to hold the latter in position. A sight hole *I* and cleaning hole *D* are also provided. The boiler is connected by means of flow and return pipes *F* and *G* respectively to heating pipes and the like, and a fume pipe *H* conveys away the fumes formed by the lamp or other heating agent.

6565. Tee, H. March 30.

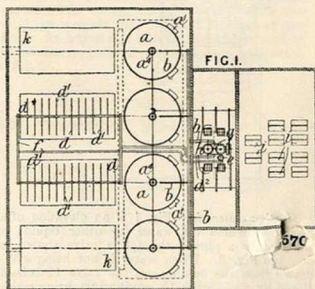

Heating by steam circulation.—Relates to improvements connected with the electrolysis of chlorides and other salts, and the evaporation of brine and other solutions. Brine or other liquid to be concentrated is put into closed vessels *a*, heated by furnaces beneath in the usual way. The steam evolved from the pans is led by the tubes *b* to the low pressure engine *g*, which drives the dynamos *h* employed in producing current for electrolyzing brine (to obtain chlorine and alkalis) or other liquid in the tanks *i*. The exhaust steam from the engine is led by pipes *d'* to open salt pans or other evaporating vessels *d* having condensing pipes *d'* therein. The pans *a* may be heated by steam produced by the furnace flues being surrounded by water.

6565A. Tee, H. March 30.

Heating by steam circulation.—Refers to the Specification of Letters Patent No. 6565, A.D. 1895, and relates to improvements connected with the electrolysis of chlorides and other salts and the evaporation of solutions. Steam at high pressure is generated in the boilers *p* heated by fuel, and is led to high pressure engines *q* developing power for driving dynamos *h* which provide current for use in electrolyzing brine in tanks *i* to obtain alkali and chlorine. The exhaust from the engines is led to chambers, below closed evaporating or salt pans *a*. The steam given off from these pans is led by pipes *d'* to condensing pipes *d* in the open evaporating or salt pans *d*. The water resulting from the condensation of steam in the vessels beneath the pans *a* is pumped back into the boilers *p* by a pump *f*¹ through the pipe *f*. Some modifications are described, in one of which a compound condensing engine is employed, the low pressure part being supplied with steam from the closed pans *a*, which are heated by the exhaust from the high pressure part, while the exhaust from the low pressure part is led to the open pans *d*.

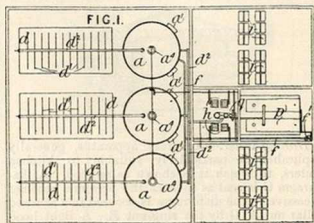

6611. Cooper, J. March 30.

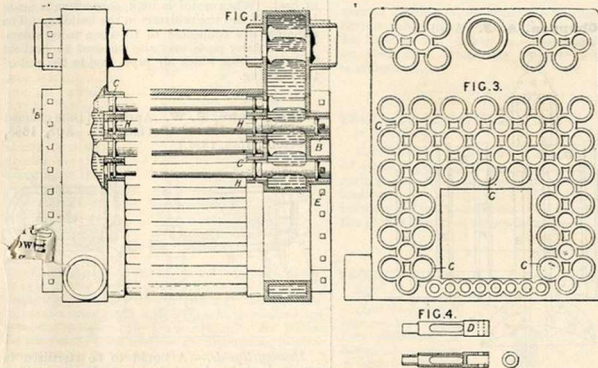

Heating water &c.—An improved sectional boiler is described. The tubes are tapered and are arranged, alternately, in opposite directions. Fig. 1 is a side elevation of a boiler, partly in section, and Fig. 3 is a view of the inside face of a header or end box. Sockets *C* are cast on this face of, alternately, larger and smaller diameter. The small end of each tube is placed in one of the smaller sockets, a tight joint being made by a packing ring *H*, by caulking, or otherwise. Its other end rests in a large socket on the opposite header, and is similarly jointed. The small end is held up against the header by a closing piece *D*, shown in detail in Fig. 4. This is passed through a socket *B*, on the outer face of the header, opposite the corresponding one *C*, and is held against the tube by a key *E* driven transversely through the socket by a bridge and screw or by other means. By this arrangement any tube can easily be withdrawn and replaced. The lower row of tubes, if used as firebars, are made parallel.

6691. Schaeffer, A. G. April 1.

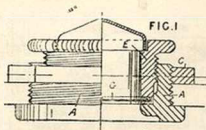

Heating water.—A safety apparatus, generally applicable, is particularly suitable to kitchen boilers, to which it is shown as applied. A diaphragm G is rent as soon as the pressure becomes excessive. The diaphragm is secured in a screwed collar-nut A, G by the ring-nut E. A light hood may be provided to keep the diaphragm clean. The holder A, C may be fitted, if desired, from the exterior. The diaphragm may be of mica or of metal, in the latter case being grooved. It may also be electroplated or provided with a non-corrosive coating. Instead of a plain diaphragm, a tube flanged at its inner end and closed at its outer end may be employed.

6705. Choppen, A. J. April 2.

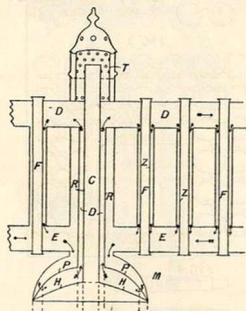

Heating buildings; boilers.—A boiler M of a hemispherical type has internal partition plates P, H, so that water rises from the boiler into the pipe R, and after circulating in the pipe system D, Z returns by the inflow pipe E. The fumes from the heating apparatus escape by a central flue C and perforated cap T, and the air of the building is heated by circulating in the tubes F.

7249. Baker, W. C. April 9.

Heating buildings

etc.—Two parallel water tubes pass through the parts A, B of the furnace, and are connected by taper tubes Q, whose larger ends screw into the manifold O, and the bottoms are attached to nipples 8 of the tube K. These pipes are connected to a dome N by the pipes P and M, the water circulating in the direction of the arrows. Two sets of fire-bars D, E are used with doors H, I. The frame G is adapted for four sections of heating tubes.

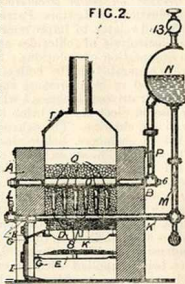

Each section forms a complete generator, so that any number may be used with suitable connections. Petroleum or other liquid fuel may be used instead of coal. When water is used, connection is made between N and the radiators in the building. The radiators are connected to 13 when using steam. The hot water pipes may also be used to heat air in a room, from which air pipes lead to the rest of the building.

7286. Kuhn, E. W. April 9. [Date claimed under SEC. 103 of PATENTS & C. A. C. R., 1883, October 15th, 1894.]

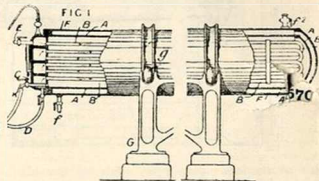

Heating liquids.—A liquid to be sterilized is rapidly heated and cooled alternately in apparatus to which an oscillatory or gyratory movement can be given. Such an apparatus may consist of an elongated cylinder A, containing a series of tubes B in connection with a partitioned chamber C for the circulation of the heating or cooling liquid, and enclosed in a jacket F for the same purpose. The surfaces of the cylinder and tubes are coated with silver or other metal not acted on by the liquid under treatment. The cylinder is charged and discharged through the cock K, and the heating or cooling liquid is supplied through the cocks D and f, and passes off through the cocks E and f'.

For the purpose of giving the necessary motion to the apparatus, it may be mounted on rollers *g* carried by the supports *G*, but other means may be employed.

7345. Postranecky, C. April 10.

Boiling pans.—The outer casing *b* of the pan has its edge perforated by holes *d* with the burr left on, so that when the casing is fitted into the cup, formed by the boiler, shell *a* and the rim *c*, and fusible metal poured in, a fluid tight joint is formed.

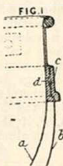

7402. Lander, M. T. April 11.

Heating air.—Fireplaces by which warm fresh air is supplied to a room, are provided at the sides and back with a chamber *A*, into which cold air is admitted by a flue *A*¹. The back of the grate is shaped as shown to obtain a greater heating effect upon the air. For regulating the admission of warm air to the room, an opening *L* at the top of the fireplace is provided with a valve plate *B*, which is held in any desired position by hooks *C* thereon engaging the edges of the opening. Behind the valve is a wire gauze screen *D*, held in position by a rebate or lugs on the grate casting. The jambs of the front of the fireplace are removable, to give access to the air chamber for cleaning purposes.

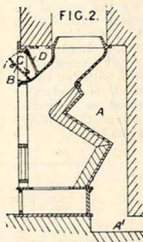

7496. Pyle, J. April 13.

Heating water by steam. A casing *A* is arranged with covers *D* and *E*. Water entering at *G* passes through a perforated plate *H*, through the casing to the outlet *J*. Steam is admitted at *K*, and passes from the tube *L* through a vertical vessel *R*, or through coiled pipes *F*, *Q*, *M*, *N* surrounding *R*, arranged so as to be about the same length. The coils *P* and *R* are single, and the third coil

consists of the tubes *M*, *N* arranged like a two-threaded screw. Short water tubes *S* cross *R* at

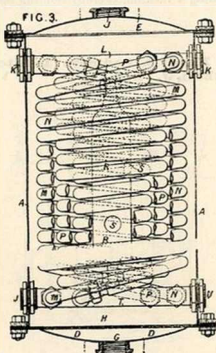

various heights. The coils are connected to a bottom tube *T*, from which the condensed steam &c. flows to the outlets *U*. This apparatus may be used as a feedwater heater with slight modifications.

7349. Edwards, E. M. April 10. *Drawings to Specification.*

Valves and cocks for kitchen boilers &c. A draw-off tap is placed immediately underneath the valve seating, and is in communication with the pipe leading to the safety valve. The tap is opened before a fire is lit, and it can thus be seen whether the pipe is frozen or otherwise stopped.

7662. Poulson, J., and Onderdonk, C. S. April 16.

Heating buildings.—Air valves for radiators. A casing *A* contains a float *G* attached to the valve stem *H*, which is loosely supported by a compound metal spring *F*. When steam enters the radiator it drives the air before it through the orifice *C*, and the expansion of the spring *F*, due to the steam,

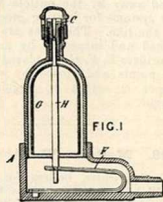

gradually closes the valve. If water enters the radiator the float G is forced upwards, thereby closing the orifice C, while the arrangement prevents water of condensation collecting at the top of the casing and forming a vacuum, thereby holding up the float and closing the air outlet.

7754. Hardy & Podmore (Limited), and Southall, J. April 18.

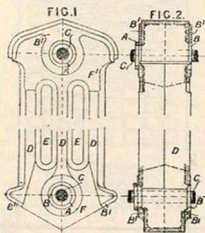

Heating buildings, radiators for. Fig. 1 is a side and Fig. 2 a front elevation of one section of a radiator which is provided with spigots A for engaging the holes B. The sections are held together by wrought iron rods C, and the fans B' are cast against metal chills so that machining is rendered unnecessary. The heating fluid circulates through the hollow arms D while the air passes upwards around them through the spaces F, E, F'.

7820. Sewell, J. C. April 19.

Non-conducting coverings.—Sheets of animal or vegetable fibre are first formed into the required shapes for covering pipes and the like, and then soaked in a solution of alum and water. The inside surfaces are coated with silicate of soda, and upon this a coating of fine clay is applied; the different coatings prevent charring of the fibres. When the temperatures of the heated surfaces are not very high, the coating of silicate of soda may be omitted, or, if this is used, the fibre need not be soaked in an alum solution.

7845. Murray, R. S. April 19.

Boiling pans.—Combined apparatus for boiling, cooling, mixing, or creaming sugar &c. for confectionery. Fig. 1 shows the general arrangement. The boiling pan A, preferably steam-jacketed, is fitted on the floor x and connected by a pipe f with the cooler B, which is preferably suspended as indicated. The mixer C is placed below the cooler.

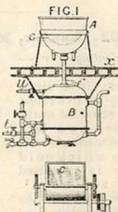

7860. Chapman, J. April 19.

Heating buildings.—A jacketed furnace A, or other suitable heating device, is connected up to the flues D, S so that the hot air and gases, in passing therethrough to the outlet D, heat the air or water circulating in the annular jackets surrounding the flues; the heating fluid is conveyed away by the outlets M, N to pipe systems for heating greenhouses and the like. The flues are readily cleaned and inspected by means of the orifices E, F, G, H placed at suitable points and closed by plugs; a damper Q serves to regulate the draught.

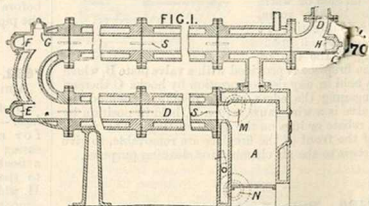

7906. McCaig, W. April 20.

Heating water, boilers for. The portable boiler A is connected to the outflow and return pipes C', B' by connecting pipes C, B and swivel joints D, E, so that when the boiler is not in use it can be raised to the position shown by dotted lines, away from the range or other heating device. The pipes B', C' lead to the hot water tank, and taps L, K are provided to cut off the supply when

1895]

ABRIDGMENT CLASS HEATING.

the apparatus is not in use, while a sludge pipe I' is attached to the fitting I.

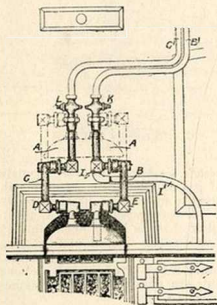

7979. Weiss, J. L. R. April 22.

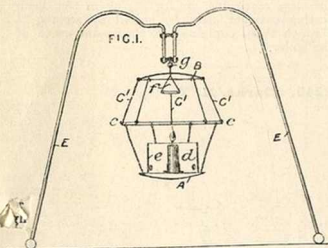

Bed warmers.—An apparatus for warming beds and promoting perspiration consists of a lamp formed by two dished metal plates A, B, connected together by wires or chains c' and a ring c . The lower plate A is fitted with a sconce d to hold a candle and a guard or chinney e , while the upper plate is furnished with a hook g for attaching to a support consisting of four legs E. The apparatus when in use is set in a bed, and the coverings are then placed over the patient and over the apparatus, so that the heat of the candle may warm the bed and promote perspiration in the patient. To extinguish the flame, the lower plate A is raised until the candle enters the extinguisher f .

8080. Tritton, C. H. April 23.

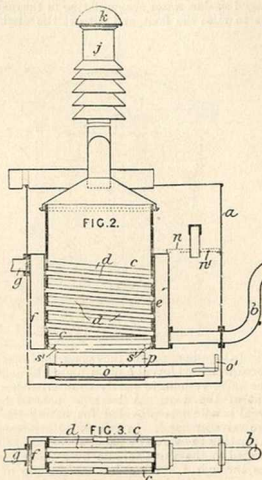

Geyer.—An apparatus for heating water in the “cups” of gas holders, in tanks, and other vessels. The apparatus is immersed wholly or partially in the water to be heated, and means are provided for draining off the water of condensation formed within it. An oblong casing a is provided with an inner shell c , having inclined tubes d connected up to water-boxes e, f , which latter are in connection with the inlet pipe b and outlet pipe g respectively. The water passing through the apparatus is heated by a Bunsen burner o supplied with gas by the pipe o' , and with air through perforated gratings n, n' . The products of combustion escape by a cowl j formed by a number of perforated cones, and having a cap k to prevent down-draught. Any water of condensation formed within the casing c trickles down, and is directed by channels s' into a slit copper tube p , partly surrounding the burner, where it is evaporated and passes away as steam through the cowl j . In modified arrangements, the evaporating device may be ribbed or corrugated, and also provided with suitable collecting gutters, and the water-tubes d may be replaced by coils or hollow plates arranged in any convenient manner.

8160. Fletcher, G. April 24.

Steam traps.—A closed casing a has an inlet b and an outlet c for condensed water, the discharge of

which is regulated by an equilibrium valve *d* provided with a valve spindle *e* carrying a float *i* arranged so that water accumulating in the casing *a* tends to raise the float, and with it the discharge

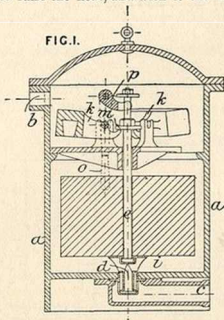

valve. In the upper part of the casing, the inner ends of three weighted levers *k* press upon the collar *m* of the valve spindle to partly counterbalance the weight of the float. A lever *p* operated by an external handle *o* is provided for lifting the discharge valve by hand. In a modified arrangement for actuating the valve by hand, a vertical spindle connected to the valve spindle by a sliding joint passes through a stuffing box at the top of the casing, thus allowing the valve to be directly lifted.

8167. Labre, A., and Coussinet, A.
April 25.

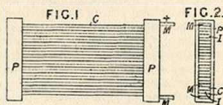

Heating by electricity.—Relates to electrical heating applicable for use in apparatus for ironing, calendering, mangling, pressing, glazing, embossing, and finishing linen or other fabrics, and for finishing hats and hot-pressing leather and similar material. The apparatus is applicable to presses used for flattening, smoothing, embossing, and moulding materials of the kind referred to. The device consists of bars or strips of carbon arranged in series, the form and dimensions of which depend upon the nature of the apparatus to which it is to be applied. In the form shown in the Figures, a series of strips *C*, arranged side by side, are separated at their ends alternately by non-conducting incombustible pieces *I* and conducting pieces *M*, the whole being clamped together in an insulating frame *P*.

8199. Lamplough, F. April 25.

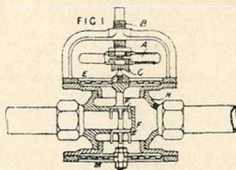

Thermostats.—Apparatus for regulating the supply of gas or oil to burners or the supply of heating-fluid to systems of heating-apparatus and the like. A corrugated capsule *A*, filled with a volatile fluid, has its lower expansible surface *C* pressing upon the spindle of a regulating-valve *F*. A screw *B* serves to adjust the capsule, and the walls *E* and *M* of the valve casing *H* are corrugated, the ends of the valve spindle being attached thereto.

8223. Defries, W., [Geneste, Herscher, & Co.].
Drawings to Specification.

Heating air.—In connection with a steam disinfecting apparatus, air for drying in the disinfecting chamber may be heated by passing it through tubes contained in the steam space of the boiler.

8245. Darke, E. T. April 26.

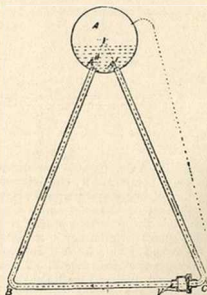

Heating water.—The invention is shown applied to a boiler in which *A* is a water drum receiving the ends *A*¹, *A*² of tubes *BA*¹, *CA*¹ united by the horizontal portion *BC*, and consists in placing in the non-return valve *v* in the system. On heating the device, horizontal portions uniformly, water will apply when

the left-hand tubes into the drum. The weight of the water in A¹, C and the partial vacuum formed in A¹¹, B causes the valve *v* to open, and the pipes are filled again, thus ensuring circulation in the water. These valves may be fitted in connection with two hollow firebars. One valve may serve two or more sets of tubes, provided it is placed in a down-cast shaft common to the sets. If necessary, a non-return valve may be placed at A¹¹.

8444. Prince, H. April 29.

Heating liquids.

— An apparatus for heating water and other liquids consists of casing *a*, with a steam inlet *c* and water inlet *d*, controlled by suitable screw down valves *c'*, *d'*, so that steam passing down the core *g* will draw the water with it through the mixing cone *f*, at the same time heating or attemperating it. The upper cone is made to slightly enter the lower end, leaving an annular space of about one sixteenth of an inch wide, and two separate outlets may be provided.

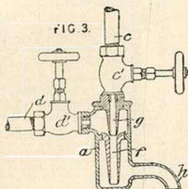

8455. Lant, J., and Cooper, J. April 29.

Heating water.

— An apparatus for supplying hot water to buildings and the like comprises a cylinder A furnished with an outer jacket through which the hot air and gases from a fire-grate G are led by means of a pipe H in the flue I, and after circulating through the jacket escape again into the flue I by means of a pipe H'. The hot water is drawn off for use in baths and the like by means of suitable pipes, and a store tank above controlled by a ball cock in the cylinder A keeps this latter well filled. In modified arrangements, straight, curved, or spiral tubes are substituted for smoke boxes at each end, cylinder A, and the hot gases circulate in the tubes instead of a jacket.

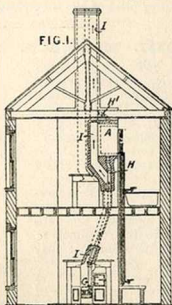

8510. Yates, E. April 30.

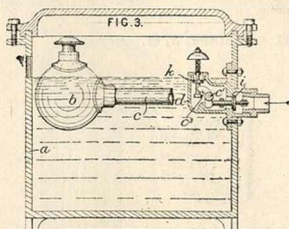

Steam traps.—Within a casing *a* is a float *b* pivoted to the valve box *d* by a trunnion hinge at the end of a hollow arm *c* and packed by a suitable gland. As long as steam from the piping fills the ball it floats upon the surface of the condensed water in the casing *a*, but when condensation takes place the water enters and the ball sinks, and thereby opens the air valve *k* and water escape valve *i* by means of the fingers *c'*, *c''* to allow water to enter the trap from the piping. As soon as the water is succeeded by steam, the ball rises and closes the valves. The air valve is arranged to close first so as to direct steam into the ball and cause the trap to operate quickly. Slightly modified arrangements are described and illustrated.

8673. Levi, L. May 2.

Thermostats.—Relates to a thermostatic apparatus for closing electric bell circuits and actuating ventilators or valves. Mercury contained in spherical bulb B, when expanded by rise of temperature, raises the piston C in a stem A till the piston rod D comes in contact with the lever F, and thereby closes an electric circuit or actuates a valve or ventilator. The bracket H carrying a lever F is adjustable in height, so that it can be fixed to bring about contact of D and F at any required temperature.

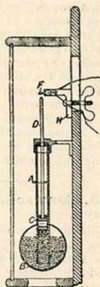

8680. Hirst, G. H., Hirst, J., Hirst, A., and Beaumont, A. May 2. *Drawings to Specification.*

Heating air.—Furnace waste gases are utilized for heating air, which is passed through a tubular

apparatus placed in the path of the furnace gases. The heated air is used for drying or for other purposes.

8751. Sheldon, J. G. May 2.

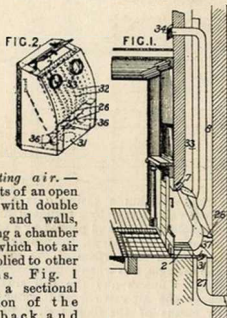

Heating air.—Consists of an open stove with double back and walls, forming a chamber from which hot air is supplied to other rooms. Fig. 1 shows a sectional elevation of the fire back and adjacent chimney, Fig. 2 a view of the heating chamber detached. The smoke from the fuel burnt on the grate 2 escapes through the damper 1 into the chimney B. A supply of hot air, available for warming other rooms, is obtained in the following manner:—Cold air entering the flue 27 passes through the aperture 31, controlled by the damper 37, into the lower portion of the back of the heating chamber. Part of the air now passes through the openings 26, and thence over the rear surface of the fire-back 1, which is provided with ribs 32 to increase the heating surface, while the remainder passes through openings 36, controlled by dampers, into the side chambers. Flanges on the side plates are arranged to prevent too free circulation of air in the side chambers. Hot air flues issue at 33 from the rear wall of the back heating chamber, and thence lead upward to other rooms, one being shown entering at 34. The air in the flues is further heated by the products of combustion passing up the chimney.

8863. Dawson, J., and Oldham, G. W. May 4.

Heating water and other liquids.—Consists in means for utilizing waste heat from boiler and other furnaces in the heating of water or other liquids, for feeding boilers, or for manufacturing purposes. Within a chamber, through which the furnace gases are allowed to flow, are arranged a number of tubes B connecting a pair of boxes C, D. The latter, preferably attached to the sides of the chamber, are divided by partitions G so as to compel the liquid to be treated to pass backwards and forwards through successive tiers of the tubes in a zig-zag path. In order to clean the exterior of the tubes a water spray, or steam, is

admitted from time to time through a perforated plate N at the top. The tubes may be fixed by means of wooden bushes H. These are compressed

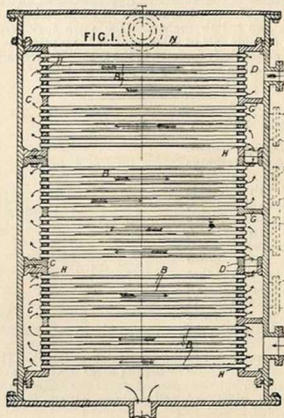

before insertion, so that on becoming moist they expand and securely grip the end of the tube, while their extremities engage with the inner and outer faces of the tube-plate.

9331. Moore, E. J. May 11.

Steam traps.—A device for intercepting sediment, before steam enters the trap, consists of a casing A provided with an inlet I and outlet O, so arranged that steam passes through a perforated disc E, whereby any foreign matter is separated and falls into the receptacle C, from whence it may be drawn off in any suitable manner. A screw cap B allows of the disc E and distance-piece D being taken out for cleaning and repairs.

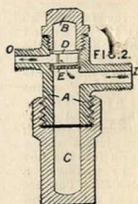

9160. Winterflood, J. May 13.

Geysers.—A vertical cylindrical casing A is provided with a ring gas burner B, the in use of combustion from which ascend by the g device. The circulate around the cage-like struc ply when

escaping through the outlet fine Q. Water is admitted by a rose or spreader T and is further

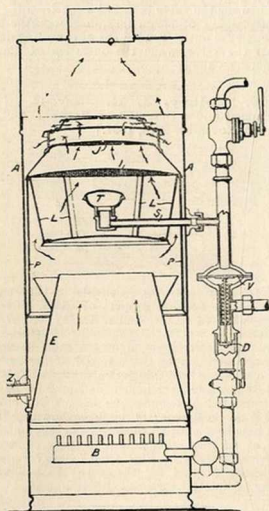

broken up by the sheets of gauze J, I, so that it is brought into intimate contact with the hot gases from the burner B and thereby heated. A small part of the water enters the annulus formed by the cylinders A, P and serves as a water-jacket; the main supply is drawn off by an outlet pipe Z. Water, entering by the pipe S, presses upon a diaphragm V so as to control the lift of a valve D, and thereby regulate the gas supply.

9524. Boulton, A. J., [Bruno Nordberg Co.], May 14.

Heating water.—Steam is supplied through the branch a^2 to one half of the annular chamber a^1 in the lower head A, passes among the tubes C, C to the other half of the annular chamber a^1 , and finally escapes through the branch a^3 . The said annular chamber is divided by partitions J, Fig. 3, which, with the plates K, K between the shell H and the tubes, prevent the steam passing direct from one branch to the other. The upper and lower heads have removable covers, b and a respectively, to facilitate cleaning, and are connected by a large central tube D. Water to be heated passes into the heater by pipe F, flows up through the tubes C

and D to the upper head B, and then passes down through the pipe E and away by the branch E'. The casing H can easily be removed to allow of

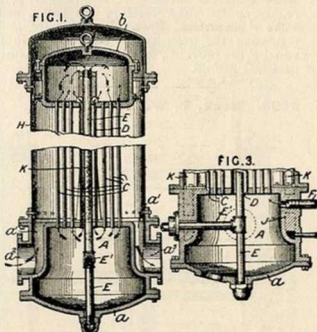

the examination or repair of the tubes. Owing to the slow movement of the water in the chambers A and B, any solid matter in suspension is deposited therein.

9563. Lawrence, W., May 14.

Heating water.

—Relates to the automatic admission and regulation of the supply of water to steam boilers or other pressure vessels without the use of an ordinary forcing pump or injector; also, in conjunction therewith to the softening, purifying, sterilizing, heating, and re-cooling of the water. The apparatus, the general arrangement of which is shown in Fig. 7, comprises a boiler or compressed vapour supply E, an "equilibrium pump" G, a precipitating and settling apparatus in conjunction with a pressure cylinder H, and a heat interchanging or cooling apparatus H. The purification and sterilization of the water are

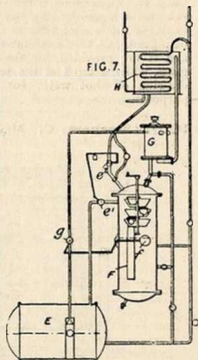

effected by the heat of the steam in the vessels F and G. When it is desired not to heat the water in these vessels, a float is employed to separate the water from the steam. A ball-valve f , g , for regulating the water level in the boiler, and a valve e^1 controlled by a blow-off valve e^2 for regulating the quantity of steam used in the vessel F, are provided, together with other usual or necessary fittings.

9680. **Beck, F. W.** May 16.

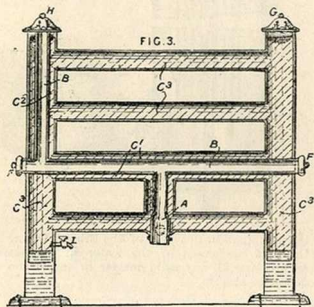

Heating by water circulation.—The hot air and gases from a lamp or burner contained within the receptacle A circulate in the tubes B, and thereby heat the water contained in the hot water system of pipes C¹, C², C³. Perforated caps or covers F, G, and H are provided for the escape of the waste gases, while a tap I at the base may be used for drawing off hot water for domestic and other purposes.

9707. **Herbert, C.** May 16.

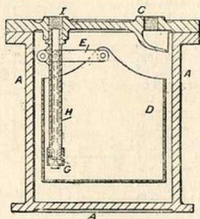

Steam traps.—A casing A, provided with an inlet C and outlet I, has a hollow float D attached to the pivoted lever E, which latter is attached to a controlling valve G by a link H. As water

accumulates in the casing, it presses up the float D and valve G until the level rises above the upper edge of the float, when the latter begins to fill, causing the valve G to fall away from the seat. The pressure of steam now discharges the water through the outlet I, until the float rises again and shuts the valve, when the operation of the float commences anew.

9708. **Delany, J. H.** May 16. [Date claimed under SEC. 103 of PATENTS &c. ACT, 1883, November 23rd, 1894.]

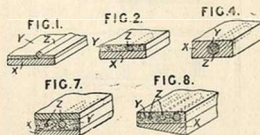

Heating by electricity.—Consists in the employment of a base or support of china, porcelain, terra-cotta, tiling, or similar earthy or vitreous material, to which the conductor is attached by vitreous enamel, having about the same coefficient of expansion. Both the material of the base and the enamel are fired at high temperatures. Figs. 1, 2, and 8 show three arrangements adapted for heaters, X being the non-conducting base, Y the enamel, and Z the conductor; in the form shown in Fig. 8, the base is of unequal thickness and the conductors are of varying cross-section to carry currents of different strengths. Figs. 4 and 7 show forms more especially adapted for rheostats, the conductors being completely surrounded by the enamel.

9802. **Moehn, J. N., Katz, J., and Mahler, A.** May 17.

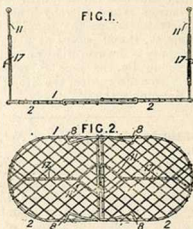

Boiling pan attachments.—The apparatus is intended for handling clothes in a wash boiler or boiling pan, and it consists of a clothes support 1 made in two sections 2, slidingly connected by the frame bars 8, so that the frame can be adapted to any size of boiler. At the extremities of the hinged handles 11, adapted when not in use beneath the support or holder, and furled when

1895]

ABRIDGMENT CLASS HEATING.

hooks 17 for holding the clothes support when elevated for draining.

9919. Schindler - Jenny, F. W., and Stotz, P. May 20.

Heating by electricity.—Relates to means for heating hollow soldering irons electrically. A refractory insulated body or block *a* is formed with perforations or channels *d, k* extending from back to front and cross channels *g* from one side to the other and with grooves *h* passing round the tapering edge and communicating with the channels *g*. The wire &c. conductor is introduced in one of the channels *c* at the top and passes through a cross channel *e*, groove *f*, and one of the channels *g*, from which it is wrapped in grooves *h* and channels *g* round the tapering edge of the body *a*. It is then passed along a groove *f* to the second cross channel *e*, lower channel *c*, groove *l*, to the channels *d, k*, and back through second groove *l* to one of the top channels *c*.

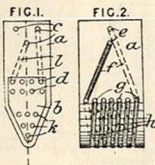

10,367. Westmorland, J. May 27.

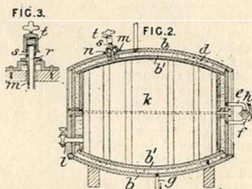

Heating liquids.—Relates chiefly to improved means for regulating the temperature of beers, wines, and beverages in casks. A casing made in halves surrounds the cask *k*, and is constructed so that the walls *b, b'*, preferably made of metal, have a layer of sawdust or felt between them. Water or air admitted to the upper half through *d* circulates through the pipes *e* and *f*, which are coupled at *h*, and leaves the lower half through *g*. A slot is cut for the insertion of the tap *l*, and provision is made for the vent peg *m* which passes through the cover *n*.

10,370. Green, A. L. May 27.

Heating air.—Figs. 1 and 2 show an arrangement for heating air for drying cocoa, coffee, tea, and the like in which two furnaces are employed, but the arrangement may, equally well, be applied to a single furnace. The furnaces are separated by a wall *X'*, and the lower portion of the chimney is divided by a wall *C'* to divide the draughts. Air is pumped through piping *D* provided with branches *E* to which are coupled perforated pipes *F* under trays *K* containing the materials to be dried. Or the pipes may be bolted to the trays direct.

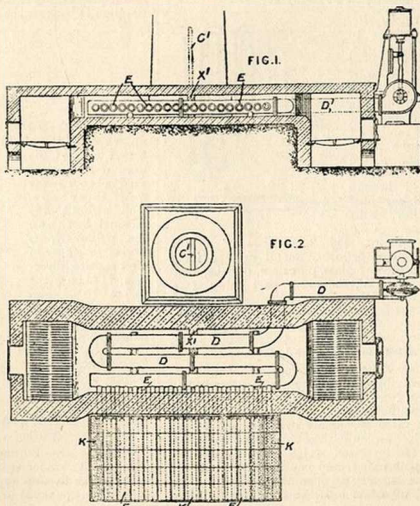

10,560. Laird, W. H. May 28.

Heating water, boilers for. The arrangement shown in Figs. 1 and 3, Fig. 3 denoting a sectional plane on the line 3, 3, Fig. 1, is that preferably employed for heating water or producing steam at a low pressure. The furnace P is surrounded by water-sections F here shown when grouped together rectangular in plan. The sections fed from the pipe G open out to the upper pipe I which, by the branch J, communicates with the main multitubular boiler A. The lower parts of the section are also in communication with the main water-space by the pipe G. The fuel, coked in the magazine above the dumping plate R, is burnt upon the grate C. Air for secondary combustion enters by apertures N, descends as shown by arrows, and passes into the furnace gases by perforations o. Ashpit air also enters from the jacket F¹¹. Heat-conducting pins F¹ projecting into the furnace are provided. For starting the fires the dampers S and U may be opened so that the gases pass direct to the uptake above the chamber A¹¹.

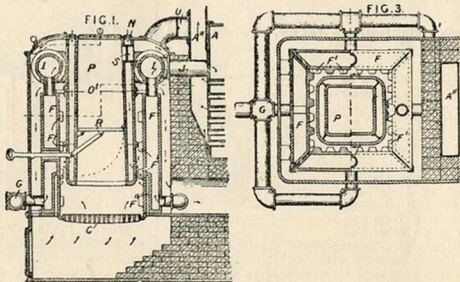

10,587. Reed, C. J. May 28.

Heating by electricity. — Relates to electric heaters, adapted for use as radiators or for heating water, flat irons, &c. As shown in Fig. 2, the radiator consists of a heat radiating tube A of the form shown, the metallic part of which is connected through a holder S, provided with a key, with the mains. The heating conductor, Fig. 2, consists of a thin coating of silver or other metal on the inner surface of a tube of glass, porcelain, or other non-conducting material, the lower part being afterwards provided with a lining of copper to which the conductors *cc* can be soldered.

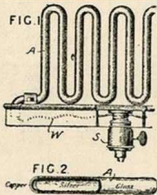

steam, pressing upon the water in A, forces it along the pipe D back to the boiler, while the spindle of

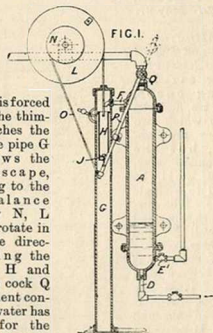

the valve J is forced up, when the thimble H reaches the base of the pipe G and allows the water to escape, while owing to the unequal balance the pulley N, L begins to rotate in an opposite direction, lifting the thimble H and closing the cock Q until sufficient condensation water has collected for the above operations to be repeated.

10,897. Peake, S. June 1.

Steam traps.—The invention relates to steam traps for use with apparatus of the type described in Specification No. 15,616, A.D. 1893. The water of condensation flows into the receiver A past the non-return valve E¹, finally overflowing into the thimble H by the pipe F. The thimble now descends owing to the increased weight, thereby rotating the coned pulley N, L and causing the band O to pull up the lever P to open the cock Q for the admittance of steam into the reservoir A. The

10,921. Davidson, S. C. June 1. *Drawings to Specification.*

Heating air.—Furnace gases which have been diluted with air for smoke consuming purposes, are mixed with atmospheric air, the heated mixture being then conveyed in the required direction when

11,016. Blackman, H. June 4.

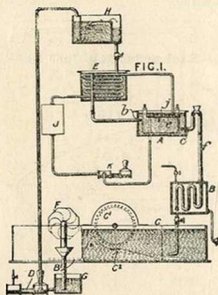

Heating liquids.—Relates to electrolysing and bleaching, A being an electrolytic cell and C a bleaching tank, the liquid employed (generally brine) continually circulating from one to the other and back again. As the liquid leaves the electrolytic cell it passes down a tube *f* and through a steam or other suitable heater B, after which it passes into the tank C. Within this, the liquid may be further heated by a coil B'.

11,081. Biles, W. June 5.

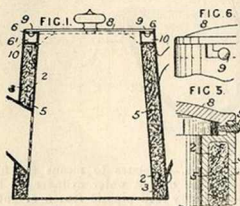

Heating water.—Vessels employed for boiling are made with double walls 2, 3, the space between which is packed with asbestos, slag-wool, or other non-conductor of heat 5. The lid 8 is attached by means of pins 9, the heads of which are passed into the enlarged ends of slots in a ring 6, and it is then secured by giving it a partial turn. Pockets 10 or clear spaces are formed beneath the slots by separate plates, or by a continuous ring 6', fixed to the double walls. In a modified form, the pins are mounted in the ring 6 and the slots are in the lid. In Figs. 5 and 6 another of fixing the lids, as applied to earthenware is shown.

11,088. Lake, H. H., [Buas, P. I.]. June 5.

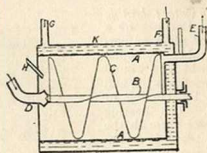

Heating liquids.—An apparatus for heating milk and other liquids, for the purpose of sterilizing the same, is composed of a horizontal cylinder A, surrounded by a steam jacket K and containing a shaft B with helical blades C for the purpose of keeping the liquid in motion. The liquid enters the cylinder at D and leaves at E, while the steam enters the jacket at F and leaves at G. An air pipe H prevents the accumulation of pressure within the cylinder.

11,351. Johnson, J. Y., [Pieper, C.]. June 10.

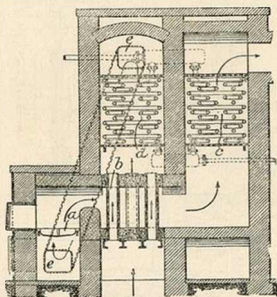

Heating air and other gases.—The superheating of the steam or gas is effected in two stages, viz., by direct action of the cooled furnace gases, and by air heated by the same. The arrangement is shown in the Figure in which the gases from the furnace *a* are shown as being cooled in passing around the air pipes *b* on their way to the second portion *c* of the superheater. The heated air from the pipes *b*, after traversing the first portion *d* of the superheater, is conveyed to the furnace ashpit by the trunk *e*.