

hollow, so that steam or hot water may be passed through to heat the saturated air.

16,811. Twells, A. H. Aug. 19.

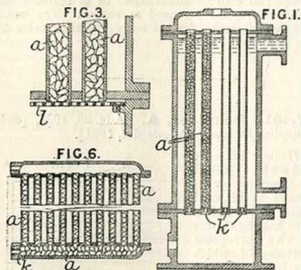

Boiling-pans; heating air; heating buildings; heating water.—In condensers, heaters, and coolers in which steam flows through tubes, the tubes are filled with pebbles or small pieces of stone. The invention may be applied to apparatus for heating, boiling, or evaporating water or other liquid, or for heating air or other gases by steam, or to apparatus for superheating, cooling, or condensing steam. Fig. 1 shows a fresh-water condenser or distiller, the pebbles *a* being supported by perforated ferrules *k*. The pebbles may be supported by a perforated plate *l*, as shown in Fig. 3. In an apparatus for heating air, shown in Fig. 6, the lower header is also filled with pebbles. Horizontal tubes of evaporators or vats or pans may be similarly filled with pebbles.

16,881. Rayer, C. Aug. 21.

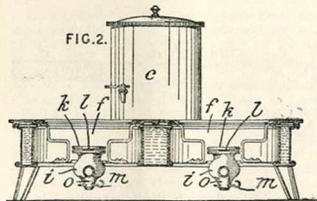

Heating water.—In a gas-heated boiler, consisting of a water casing having openings *f* in which burners are located, the burners are provided with adjustable caps *k* by which the outlet of gas from a

collecting-chamber *i* is regulated. As shown on an enlarged scale in Fig. 4, the cap *k* is mounted on a shaft *l* which passes through the gas chamber *i*. The shaft *l* is provided at its lower end with a pin *m* working in grooves in an extension *o* of the

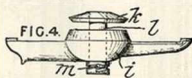

chamber *i*. On the cap *k* being turned, the space between the cap and the gas chamber is increased or diminished. A cylinder *c* serves as a water reservoir to the boiler. Cooking-vessels may be placed in the openings *f*.

16,973. Weaver, J. J. Aug. 22.

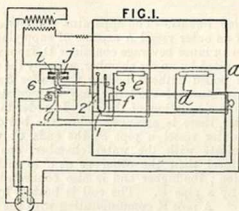

Heating by electricity; thermostats.—Relates to incubators heated by means of electric radiators and provided with a thermostat or thermostat-like apparatus for throwing some of the radiators into and out of circuit so as to regulate the temperature. Fig. 1 shows one arrangement, in which the incubator *a* is heated by radiators *d* which are always in circuit and by additional radiators *e* which are thrown into and out of circuit by a switch *g* operated by the segments *b* connected to an armature placed between the magnets *i, j*. A maximum-and-minimum thermometer *f* having contacts 1, 2, 3 is placed inside the incubator, and the circuits are arranged as shown so as to throw the radiator *e* into and out of circuit as the temperature reaches its lower and higher limit respectively. In a modification, an ordinary mercury thermometer is used, with a contact placed so as to close a circuit when the temperature reaches its higher limit. In this form, the radiator *e* is always in circuit unless the temperature rises too high, when contact is made and a magnet energized and a switch operated to throw the radiator *e* out of circuit.

17,364. Heibel, H. Sept. 1, 1904, [date applied for under Patents Act, 1901].

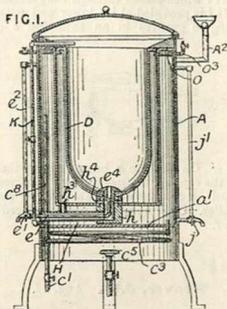

Heating liquids.—The apparatus consists essentially of an outer vessel A capable of supplying hot water to an inner beverage container D, from which it is separated by an air chamber, whereby the water may be boiled without boiling the coffee &c. and the temperature of the latter may be regulated by permitting circulation of the air. In order to heat the water, there is arranged below the bottom a' of the outer vessel a pipe e', the ends of which communicate with the water chamber, one at a higher level than the other as at e' to maintain circulation; the higher end is also connected to a supply by a pipe e'. The coil is heated by the burner e'. A pipe K communicating with the lower part of the chamber A serves to supply hot water to the usual coffee bag in the vessel D. For drawing off the coffee, there is a pipe e with stop-cock e' connected with the bottom of the vessel D by a boring h and a hollow screw e'. To protect it from the

water, the pipe e is encased in a larger pipe H, which forms an air chamber round it, in communication with the air chamber surrounding the vessel D by the pipe h' and holes h' in the stuffing-box so as to permit circulation. Pipes e, e', provided with cocks, by means of which hot air may be allowed to escape and cool air admitted so as to regulate the temperature, are arranged as shown. The usual gauges e', j', cock j for hot water, and relief valve A² are provided.

17,451. Schröder, A. Aug. 30, 1904, [date applied for under Patents Act, 1901].

Heating air.—In a double-walled chamber or oven heated by air, cold water enters at 1, 2 into heating-boxes 3, the corrugated bottoms of which are heated, e.g. by gas. The bottoms 4 slope upwards to the back and are provided with a passage 10 leading into a rear aperture through which the combustion gases pass up to the chimney. The flow of cold air is regulated by manifold perforated slides operated by lateral levers such as 11. According to the Specification as published under the Act of 1901, the heating-chamber may be filled with metal turnings &c. and air is led to the hottest part of this chamber and thence by apertures into a distributing-chamber over it; the gas pipes below the heating-chamber are adjustably supported by screw holders along the longitudinal recesses in the bottom of the chamber; the middle pipes are made shorter than the outer ones.

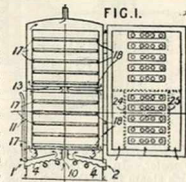

17,584. Moon, R. Aug. 31.

Thermostats.—Apparatus for indicating and controlling temperature by opening and closing valves, windows, doors, &c., and for operating fire-extinguishing sprinklers and alarms, consists of a tube e capable of sliding over a fixed tube b connected by flexible piping c to tubes or vessels a containing the oil or other expanding liquid. By means of the projection d attached to the tube e, the latter is connected up with the damper, valve, &c. controlled. A similar but more compact arrangement supported on a board is described, and the adaptation to a greenhouse for opening the

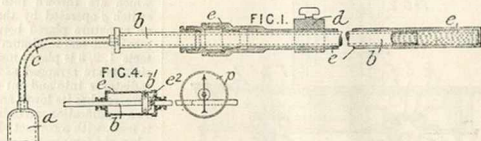

fanlight is also shown in the Specification. In the modification shown in Fig. 4, the closed pipe b slidably through the ends of the cylinder e communicates through apertures e' with one side of the piston b' fixed to the tube b, which may be provided with indicating-means p.

17,642. Bonnicart, J. Aug. 31. [*Loubatières & Co., H.*].

Footwarmers.—Figs. 1 and 2 are part longitudinal and transverse sections, and Fig. 4 a part underside plan, of a carriage heater. The cover-plate 1 is attached to a lower plate 2, from which the outer perforated mantle 5 is suspended so as to enclose the combustion cylinder 6, this being supported on the bottom plate by the flange 7. To heat the top plate uniformly, conducting metal tongues 10 are riveted to the flange 7 so as to be in contact with the top plate as shown, and have their inner ends bent over the fuel-holder 9, which is mounted on a door 8 forming the bottom of the cylinder. A non-conducting slab 4 is fixed to the cover-plate above the cylinder. In an alternative form, the flange is dispensed with and the tongues are riveted directly to the plate 1. The heater is mounted with the top plate level with the floor, the stove being exposed to the air under the carriage so as to give the draught for the combustion of solid petroleum or other briquetted fuel. In the form shown, the door 8 is secured by a hook 12 carried in a tube 13.

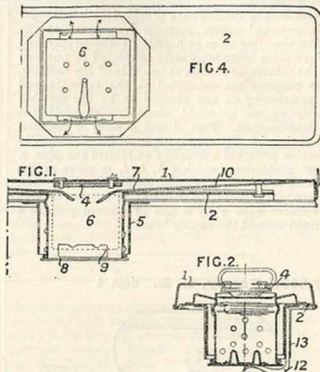
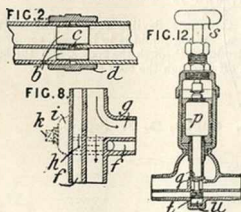
17,750. Nesbit, D. M. Sept. 1.

Heating buildings &c.—In a one-pipe steam heating-system, the flow and return passages are made of different cross-sectional areas, that of the flow passage being the larger. The divided pipes are coupled by means of internal hollow nipples or ferrules *b* which keep the passages in alinement. The ferrules are provided with bead-like surfaces *c* which are compressed between the meeting edges of the pipes so as to make sealed joints. The pipes may be drawn together by an external socket *d* or union, or by bolts passing through flanges on the ends of the pipes. A T-piece, Fig. 8, for coupling the divided pipes has a continuous return passage *f* and a continuous flow passage *g* through the right-angled portion. The return passage *f* is connected to the corresponding passage on the branch by a hollow belt-like projection *h*. A boss *i* having a plug *k* allows the passages to be inspected and cleaned. A discharge pipe may be

fitted to the boss. The valves arranged on the pipes have double openings to control the flow in each passage in the pipe. Fig. 12 shows a screw-down valve in which a valve *u* controlling the larger passage carries at its lower end a valve *t* having an opening *u* to control the smaller passage. The valve stem carries a chamber *p* for holding shot. The valves may be operated by the spindle and hand-wheel *S*. The divided pipe is also shown applied to the upward and the downward steam heating-systems.

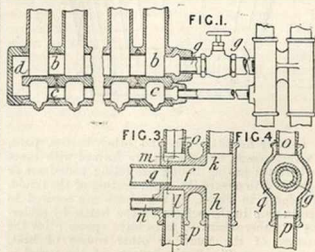
17,791. Nesbit, D. M., and Ashwell & Nesbit. Sept. 2.

Heating buildings &c.—In radiators having the flow and return passages connected to one end only,

the sections or columns are provided with two separate flow and return passages *b, c*, arranged one below the other so as to permit of the supply and return pipes being separately connected to one end of the column or section at one side of the radiator. The passages are connected at the opposite end only, either by an end piece *d* or by the member itself, so as to avoid short-circuiting of the heating-medium. Figs. 3 and 4 show a common connexion for the supply and return pipes. The junction piece has a branch *f* to receive the pipe *g*. Four projecting branches *h, k, l, m* serve as the general supply and return main branches. The return pipe *n* from the radiator is connected with the return main *p* by means of a cored passage *q* formed around the supply branch *f*.

17,853. Terrey, E. L. Sept. 4.

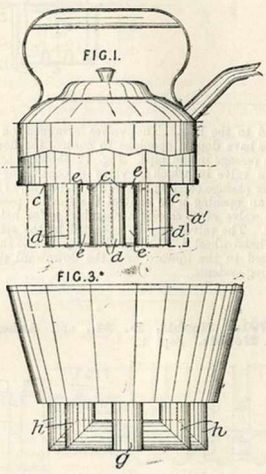

Heating liquids.—Tea and other kettles, pans, cooking-vessels, and the like are formed with bases or bottoms having hollow projecting containers or holders *d* to ensure the rapid heating of the liquid. As shown in Fig. 1, the containers are secured in apertures *c* in the bottom of the kettle by soldering or other means so as to leave spaces *e* for the passage of the flame or other source of heat. As shown in Fig. 3, the bottom of the vessel is provided with cup-like containers *g* and tubular containers *h*. The containers may, however, be of any shape or number. They may be attached to

or formed out of, the bottom of the kettle, as by stamping. A protecting-shield *a'* may be arranged around the containers.

[Reference has been directed under Patents Act, 1902, to Specifications No. 4286, A.D. 1876, No. 16,698, A.D. 1886, No. 7421, A.D. 1887, No. 703, A.D. 1896, and No. 19,835, A.D. 1902, [Abridgment Class Hollowware].]

17,963. Nogué, R. Sept. 5, 1904, [date applied for under Patents Act, 1901].

Heating air; heating liquids.—Apparatus for the production and supply of hot air or liquid under pressure for medical or dental purposes consists of a reservoir *a* fitted with cocks *c, e*, pressure gauge *f*, safety-valve *g*, and thermometer *h*, and heated by a lamp *i*. Air is forced into the reservoir and heated, and is drawn off as required through a flexible tube *j* connected to a hand-piece. When liquid is to be used, compressed air is introduced through the cock *e*, and the liquid is drawn off through the cock *c*.

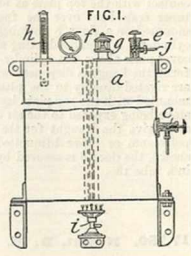

18,050. Gibbs, G. J. Sept. 6.

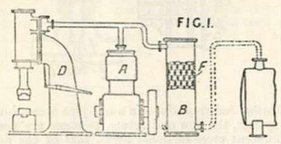

Heating air.—In a compressed-air installation, a heat accumulator abstracts the heat of compression from the air passing from a compressor to a reservoir, and afterwards restores the heat to the air as it passes from the reservoir to the apparatus to be driven. In the form shown, a compressor *A* normally supplies a compressed-air hammer *D* directly with hot air, but delivers into a reservoir by way of the heat accumulator *B*, when the hammer is not working; upon restarting, the hammer is supplied partly from the compressor and partly from the reservoir, the air from which is re-heated as it passes through the accumulator *B*. The accumulator is provided with cast-iron or other heat absorbing grids *F* as shown, or with depending pipes, containing water or a chemical

solution, of alum &c., which preferably communicate with a closed overhead chamber provided with a liquid inlet and regulating-cock.

18,216. Bolze, H. A. Sept. 8.

Heating buildings &c.—By an arrangement of connecting-pipes, a hot-water system for heating buildings may be supplied with water at different temperatures. Fig. 2 is a diagrammatic view of a portion of the installation, in which *a* represents the heating-means for supplying water of the usual temperature, and *i* the means for supplying very hot water. A rotary pump *b* causes the circulation of the water, which passes along pipes *e*, *f* to the radiators as shown. The two pipes may be connected by a pipe *g* fitted with a valve *h*, in order

that the two liquids may be mixed together when and as desired. Cocks *p*, *h* or a three-way valve *m* permit the regulation of the supply to the various radiators. By supplying the hot water only, a

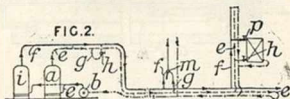

radiator or bath-water may be readily raised to the required temperature. In a modification, only one heater is employed, the warm water being circulated without any further heating except that afforded by the addition of the hot water proceeding from the heater.

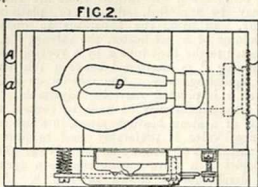
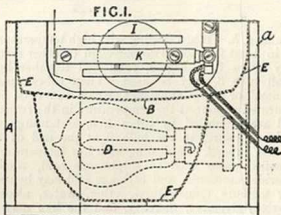
18,265. Scott, W. H. Sept. 9.

Heating by electricity; thermostats.—Apparatus for warming infants' food &c. consists of a box or receptacle *A*, open at the top, and provided with supports or recesses *a* for a bottle or food-container. Heating is effected by an electric resistance of any form, preferably a lamp *D* kept at low incandescence, by connecting in series with another lamp, which may serve as a night lamp, or by using a lamp having more than one filament in series. *A* perforated or reticulated guard *B* is provided. The box may contain a layer of non-conducting material, and have a metal lining *E*. Any form of

thermostatic regulator may be fitted, that shown consisting of a capsule *I*, the expansion of which acts upon a lever *K* to separate contacts, which are normally pressed together by a spring. Napkins and the like are dried by being placed over the upper part of the box, and at the same time serve to retain the heat within.

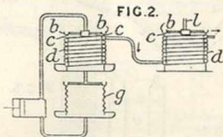
18,321. Birk, A. E. A. Sept. 11.

Heating gases and liquids.—A heat-interchanging apparatus consists of a liquid distributor *b*, a transmission surface *c*, and a tubular coil *d*. The apparatus is arranged to work on the counter-current principle. The convolutions of each coil are in contact with each other and are continuous. Fig. 2 shows an arrangement in which the liquid to be gasified is passed through two sets of coils, while different kinds of liquids or liquids at different temperatures may be passed over the coils. The liquid to be treated passes upwardly through the coils in succession. The cooling-water which has passed over the first coil may be collected in and passed over a series of corrugated plates *g* to be re-cooled. The second coil has a continuous supply of fresh water by means of the pipe *l*.

[Reference has been directed under Patents Act, 1902, to Specifications No. 3169, A.D. 1887, No. 17,570, A.D. 1891, No. 17,735, A.D. 1895, No. 17,694, A.D. 1902, and No. 3917, A.D. 1904, [Abridgment Class Cooling &c.]]

18,482. **Factow, H.** Sept. 13.

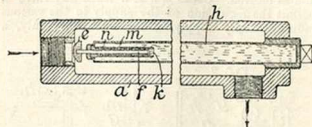

Steam traps; thermostats.—The valve *e* of an expansion type steam trap or other temperature-regulated apparatus is closed by the expansion of mercury or other liquid in a tube *h*. When steam enters the casing *a*, the pressure of the liquid, due to its expansion, acting upon a head *k* formed on the valve-rod *f*, and working in a tube *m*, closes the valve against the action of a spring *n*.

18,507. **Fournier, J. B.** Sept. 13.

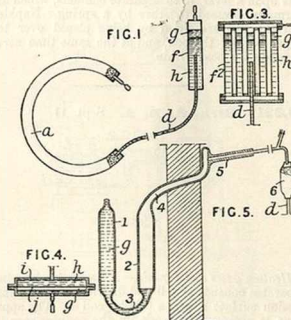

Thermostats.—Relates to means for utilizing variations of temperature for operating temperature indicators, valves, and brake or other mechanism. The indicator &c. is operated by a bent tube, as in a Bourdon pressure gauge, which tube is connected by a small flexible tube to a small reservoir or bulb *f*, Fig. 1, partly filled with volatile liquid and partly with non-volatile and nearly inexpandible liquid, such as mercury, which also fills the flexible tube *d* and the bent tube *a* of the indicator &c. This bent tube contains, in addition to the mercury &c., as large a quantity as possible of a less expandible substance such as sand. The part of the apparatus containing the volatile liquid is exposed to the varying temperature, and its maximum vapour pressure is transmitted to the bent tube of the indicator &c. The end of the flexible tube *d* within the reservoir, Fig. 3, is so situated that all planes passing through the end

divide the reservoir into equal parts. The reservoir may consist of a bundle of tubes *f'*, Fig. 3. Or a box *i*, Fig. 4, may be used with a central flexible diaphragm *j* between the volatile and non-volatile

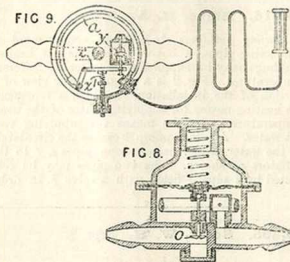

liquids *g*, *h*. When dealing with high temperatures as in blast furnaces, two porcelain or other refractory tubes 1, 2, Fig. 5, connected together by a small tube 3, may be used. These tubes contain a metal or other substance, which can exist as a saturated vapour at the temperature in the furnace, and are connected by tubes 4, 5, containing a gas under pressure, to the bulb 6 at the end of the flexible tube *d*. In dealing with low temperatures, liquefied gases such as sulphurous acid, methyl chloride, ammonia, and carbonic acid may be used. For medium temperatures, ether, water, alcohol, benzine, glycerine, mercury, and the like may be used and the intermediate liquid dispensed with. Before being filled, the various tubes are washed and may be nickelled, silvered, or platinized internally. In using the apparatus to operate the regulator of a gas heater, the valve *y*, Fig. 9, is connected to the bent tube *a* by a rocking lever *x*. A spring *z* is interposed between this lever and a regulating-screw. The spindle on which the lever *x* is pivoted may be adjustable. A similar arrangement may be used to control the regulator of a steam heating-system, in which case a reducing valve is preferably used to prevent sudden variations of pressure on the valve *y*. This may consist of a valve *o* connected to a spring-pressed diaphragm as shown in Fig. 8. The temperature in a furnace burning coal, coke, gasolene, alcohol, coal-gas, &c. may be kept constant by a regulator operated by the bent tube *a*.

18,596. **Reyscher, K.** Sept. 14.

Heating air.—An arrangement for drying materials comprises an air-compressor *a* which compresses and thereby heats the air withdrawing through pipes *r*, *i* in the centre of the drying-chamber *t*, and forces it through the tubes *i*, whence it escapes through an air motor *e* to the condenser *m*. The

materials are contained in the chamber *t*, which is separated from the chambers containing the pipes *i*, *i'* by a perforated diaphragm *o* and similarly divided off at the tops from a series of chambers *o*. In connexion with each of these chambers *o* is a fan which circulates the air from the chamber *t* through the chamber *h*¹ and among the tubes *i*¹, where it is heated by the hot air withdrawn from the centre through pipes *r*, and into the chamber *o*, whence it again passes to the drying-compartment *t*. The air is thus continuously circulated and heated by contact with pipes through which is withdrawn the moist air heated by the compressed and previously-used air in the tubes *i*.

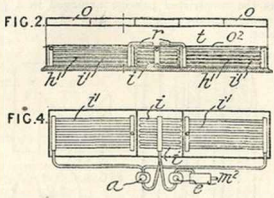

18,788. McAlear, J. Sept. 18.

Heating buildings.—Relates to a steam heating-system in which the use of ordinary radiator air valves is avoided, the air being removed from the radiators without discharging into the atmosphere. The radiators are provided with drip openings and constricted passages, through which only air and a relatively small quantity of steam are conducted, leading from the supply pipes to the drip openings. Two forms of the heating-system are shown.

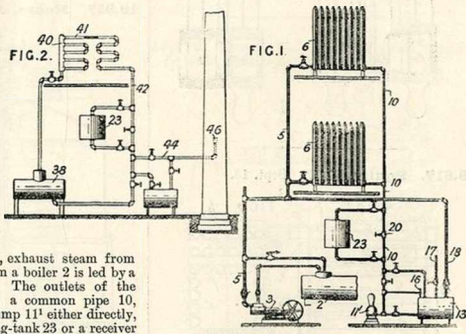

As shown in Fig. 1, exhaust steam from an engine 3 or live steam from a boiler 12 is led by a pipe 5 to the radiators 6. The outlets of the radiators communicate with a common pipe 10, which leads to an exhaust pump 11¹ either directly, or indirectly through a cooling-tank 23 or a receiver 13. The pipe 10 is provided with a valve 20, which, when closed, causes the vapour or discharge from the drip openings to pass by valve-controlled pipes to the cooling or condensing tank 23. The tank 23 may be utilized as an indirect radiator coil. When another valve in the pipe 10 is closed and the valve 20 opened, the vapour passes through valve-controlled pipes to the receiving-tank 13, which is provided with a pipe 17 open to the atmosphere, an air-valve 16, and a pipe 18 leading to the supply

pipe 5. As shown in Fig. 2, steam from a boiler 38 passes to a coil 40 consisting of two heaters connected by a pipe 41 having a partition wall or diaphragm and restricted opening, as described in Specification No. 18,788, A.D. 1905. The return pipe 42 communicates, as previously described, with a cooling-tank and receiver and also has a branch 44 leading to a nozzle 46 located in a shaft.

18,788A. McAlear, J. Sept. 18.

Heating buildings &c.—Relates to a radiator having a constricted passage, through which air and a relatively small quantity of steam are conducted, communicating on one side with the intake opening and on the other side with the discharge opening. Figs. 1, 4, and 5 show different constructions. As shown in Fig. 1, the steam chamber 9 of the last loop is separated from the steam chamber 5 of the contiguous section by a wall 8. Above the wall 8 extends a wall 10 which forms with a short cross

wall 11 a passage 12. The wall 11 has a restricted opening 13, so that steam, on arriving at the last section of the radiator, passes up the passage 12 and through the opening 13 into the chamber 9 before reaching the outlet 7. An opening 12¹ closed by a plug is provided in the upper wall of the section for access to the opening 13. As shown in Fig. 4, the constricted passage is in a pipe outside the loop. The upper end of the pipe has a T-shaped piece 15 within which is located a diaphragm 16 having a constricted opening through which the steam is allowed to pass from one section to another. Fig. 5

shows the constricted passage arranged in a pipe 18 connecting the upper portions of contiguous sections.

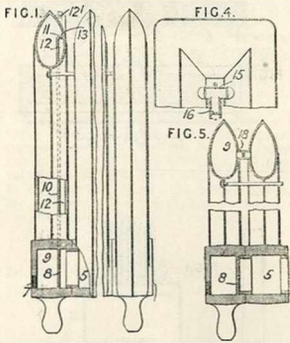

18,817. Squire, T. F. Sept. 18.

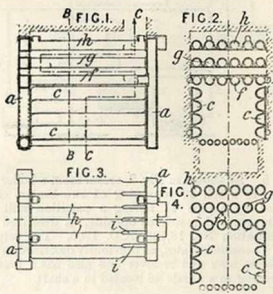

Heating water.—In tubulous hot-water boilers, the tubes are made of a more or less flat-sided section and are placed close together so as to take the place of baffles for the greater portion of their length. The tubes may be reduced at their ends so as to allow the furnace gases to pass in a serpentine course to the chimney. The flattened tubes also form the sides of the furnace space. Fig. 1 shows a sectional elevation of a boiler thus constructed; Fig. 2, a cross-section on the line B-B, Fig. 1; Fig. 3, a plan; and Fig. 4, a cross section on the line C-C, Fig. 1. The tubes forming the sides of the furnace are made with outer flat faces and

placed in contact. They are reduced at their extreme ends only where connexion with the headers *a* takes place. The water tubes *f, g, h* are also of D-section and placed in contact, but, where openings are required for the passage of the gases, they are reduced in width, as shown at *i*, Fig. 3, where the ends of the tubes are made circular. The tubes in the rows *f, g*, are similarly reduced in cross-section where necessary. The path of the gases is indicated in Fig. 1 by the section line C-C. In a modification, the tubes are uniform in their lengths, external junction pieces connecting the flue-spaces being provided. In a further modification of boiler, the upper rows of tubes are lengthened and the chimney outlet placed behind the rear header at the base of the boiler.

18,837. House, J. Sept. 18.

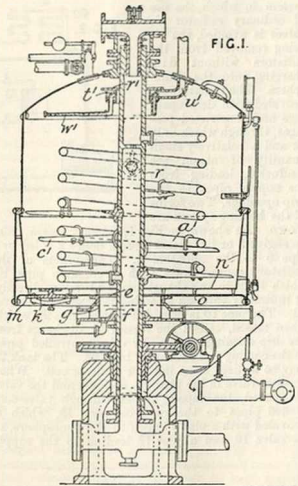

Digesters.—Relates to a vessel which serves as an infusion or decoction mash-tun and digester, a raw grain gelatinizing and converting vessel, and a worts boiler and cooler, and is suitable for carrying out the process of brewing described in Specification No 18,351, A.D. 1905. [Abridgment Class Beverages]. The base of the vessel is provided with a perforated lining *n* with conical walls supported by ribs *o*. A hollow rotary shaft *r*, through which steam or water may be passed and which carries a spiral tube *a'* or radial loops of

tubes and curved stirring-blades *c*, passes vertically through the vessel. An opening *e* in the base of the vessel communicates with a casing *f* forming an underback and provided with a cylindrical perforated wall *g*. A second opening *k* in the base is closed by a dropping door *m*. A sparger in the upper part of the vessel consists of a fixed casing *r* and a rotatable casing carrying vanes *v*, against which the water is delivered by a pipe *w*. The water is sprayed through the perforated arms *w*.

18,861. Thouaille, H. R. Sept. 19.

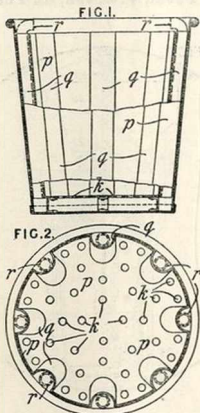

Boiling-pans.—An apparatus, adapted to be placed in a washing-boiler to enable the clothes to be washed with a small quantity of water, consists of a shell *p* fitting within the outer boiler shell. The shell *p*, the perforated bottom *k* of which is supported at a short distance from the boiler bottom, is formed with channels *g* which convey water from the bottom to the top of the vessel. Instead of the channels *g*, tubes *r*, having their ends bent towards the centre of the boiler, may be fixed to the inner shell. The Provisional Specification sets forth a modification in which a central tube with a top spreader is employed.

18,923. Reid, R. Sept. 19.

Heating liquids.—Relates to an apparatus for making oil gas, the apparatus being usable also for other heating purposes. The generator comprises a

series of tubes *D*¹, *D*², supported by a plate *D*³, Fig. 3, inside a casing *F*¹, which is heated over a grate *F*² or gas-burner *F*³. The outer tubes *D*¹ are connected in pairs by short conduits in the plate *D*³, the inner tubes similarly by the U-tubes *d*. The liquid is supplied at either end of the series from a tank.

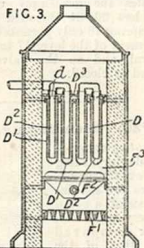

19,276. Ruud, E. March 27, [date applied for under Patents Act, 1901].

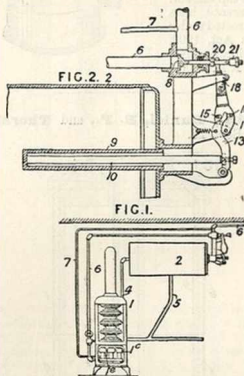

Heating water; thermostats.—A thermostatic device, for use in connexion with hot-water storage tanks, consists of an expandible rod which, by means of an arrangement of levers completely and instantaneously opens or closes the gas-supply valve. Fig. 1 illustrates the general arrangement of the coil-tube boiler 1 and storage tank 2 connected by the usual pipes 4, 5. The burners 1^c and pilot jet 1^a are supplied with gas through the pipes 6, 7 respectively. The expandible tube 9, Fig. 2, projects into the tube 2, and secured to its closed end is a rod 10, the extremity of which bears against a spring-held pivoted lever 13. The free end of this lever acts against one or other of two stops 15, 16 on a pivoted lever 17, which

operates the gas-supply valve 8 by means of shoulders 20, 21 threaded on the valve spindle. The spring 18 only permits a complete and sudden movement of the lever 17 to the right or left of the vertical, and so the valve is either completely opened or closed.

19,720. Glendinning, W. M. Sept. 29.

Heating water.—A boiler for heating water for greenhouses and the like consists of a coil *d* of very small diameter compared with that of the flow and return pipes *e, f*, to which the coil is connected. The coil is located in a casing near the top thereof. [Reference has been directed under Patents Act, 1902, to Specification No. 14,501, A.D. 1900.]

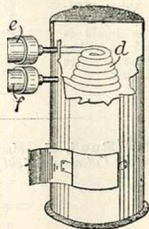

19,724A. Daniel, E. F., and Thornley, G. Sept. 29.

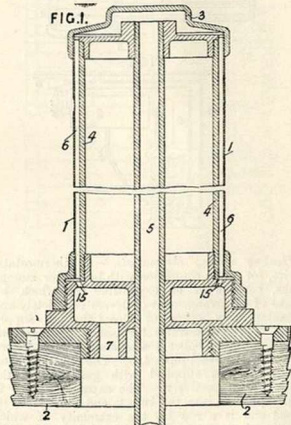

Heating liquids and gases.—Relates to apparatus

for cooling or heating fluids, particularly applicable to the cooling of brewers' wort and the like. An outer tube 1, closed by a cap 3 and suitably supported within the containing vessel 2, is fitted with a core 4 and an internal tube 5 through which cooling-water is supplied to the space 6 between the tube and the core. Ports 15 communicate with the outlet 7, from which the water may be conveyed to a cooler and returned to the inlet pipe 5. A number of such arrangements may be fitted to one vessel.

19,740. Pebal, V. E. von, and Fuchs, F. Sept. 29.

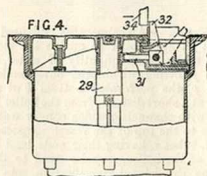
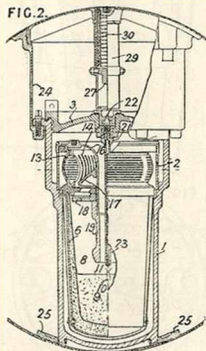

Heating by chemical action; heating gases.—Thermit is utilized to heat compressed air or gases employed in driving automobile torpedoes. The act of launching fires a fuse which ignites the thermit, and, when the reaction of the material is complete, the air, which at first passes direct to the motor, is allowed to impinge on the molten mass,

the change of path being determined by the movement of a double-seated valve actuated by the fall of pressure of the compressed air. Fig. 2 shows a cross-section of the heating-apparatus, which comprises a cylindrical casing 1 into which the air is admitted, and which is fitted with an airtight cover 3 and is rigidly secured to the torpedo shell by means of lugs 25 at the bottom and by attachment to a cylinder 24, itself secured to the shell, at the top. The casing 1, which may be lined with non-conducting material, supports an inner cylinder 3, which is screwed and soldered to it, and to which are attached a funnel 16 terminating in a nozzle 19, which forms the air inlet, and perforated curved portions 13, 14 enclosing an annular space which is packed with steel gauze, through which the air flows before reaching the outlet. Baffles 17, 18 are supported by the funnel 16. The thermit 9 is placed in a casing 8 of white metal within an iron crucible 6 which is lined with magnesite. A thin copper covering-plate 11 and a fuze 10 are provided. The igniting-fuse consists of a plug 21, carrying a percussion cap, and a cup-shaped firing-stud 22, operated by a striker 27 under the influence of a spring 30, and normally locked by a bolt 31, Fig. 4, engaging the guide-sleeve 29. On launching, a projection 34 strikes against a lever 32 attached to the bolt 31, and releases the striker. The flash of flame from the percussion cap passes down a small tube 23 and ignites the fuse 10, thus starting the reaction of the thermit, which melts the covering-plate 11 and allows the air or gas to impinge on the surface of the mass.

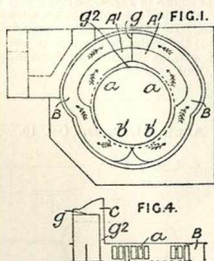
19,949. Clayton, W. Oct. 3.

Boiling-pans.—The steam arising from a boiling-pan is carried off through an arrangement of horizontal and vertical flues surrounding the pan. Fig. 1 shows a plan of the arrangement and Fig. 4 a sectional elevation of a portion of the flues. The vapour escapes through four series of perforations a, a', b', b' into two horizontal flues A', A', B, B , each of which is divided by the vertical partition g .

By means of a bent sheet, a narrow vertical flue g^2 is also formed, the whole five passages opening into the uptake c , which leads into the chimney.

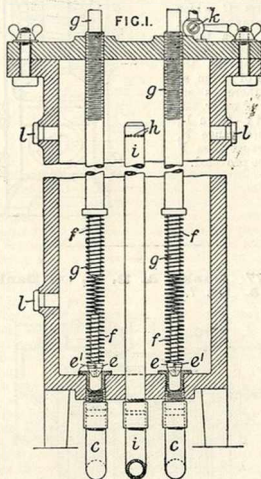
20,048. Douglas, A. Oct. 4.

Steam traps.—Relates to steam traps in which spring-controlled or weighted discharge valves are opened by the pressure of accumulated water of condensation. In a casing, one or more vertically-disposed valves e close the inlets c leading from a chamber in which the water of condensation collects. The valves are normally held on their seats by springs f which are adjusted by the screw-threaded spindles g projecting through the cover of the casing. A water-outlet pipe i having escape orifices h is carried to a high level so that a quantity of liquid is maintained above the valves e . A small passage e' through the valve e allows the inlet c to communicate with the interior of the casing when the valve e is on its seat. In action, the valves e lift when the pressure of the water of condensation on the underside of the valves reaches a certain value. Some of the liquid in the casing then escapes by the pipe i . An air-escape pipe k is provided in the cover, which is secured to the casing by bolts and nuts. Openings l in the casing are arranged for attaching a gauge glass.

20,159. Mathewson, J. E. Oct. 5.

Heating air.
Consists in heating air, particularly compressed air, by passing it through a worm C which is immersed in water in a boiler A. The boiler is closed against the escape of steam, so that there is no waste of water. A safety-valve D, pressure gauge E, and gauge-glass F may be provided.

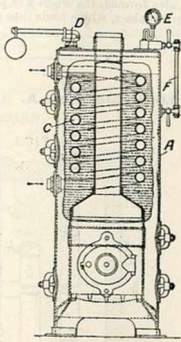

20,277. Danks, A. B. C., and Danks, J. A. Oct. 7.

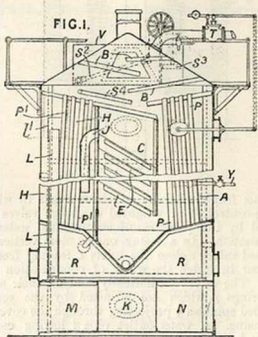

Heating water.—Water, supplied at the top of the apparatus through the float-regulated valve T, is heated by exhaust steam as it descends the inclined shelves B and mixes with chemicals supplied by the pipe s' in the chambers A. Some of the impurities are deposited on angle-pieces or plates E in the chamber C, which the water leaves by the pipe J, and others in the chamber H. A pipe L, having a circular shield l' at its top conducts the water to the chamber M, whence it passes through

a wood-wool filter K to a chamber N to which a boiler feed-pump may be connected. The exhaust steam is supplied to the chamber R and heats the water in the chambers A, C as it passes upwards through pipes P, P' before coming into direct contact with the water on the shelves B. Live steam and air may be passed into the chamber A through the pipe Y. The shelves B, tubes P, P', and chamber R may be omitted and the water heated previously by independent means or by the introduction of live steam. It is stated that water treated in this way may be used for feeding boilers generally; in laundries, for boilers, heaters, condensers and circulators; in laundries and textile manufactories, for washing, dyeing, colouring, and bleaching purposes; in hydraulic presses; and for washing clay and ores.

20,283. Cotton, G. Oct. 7.

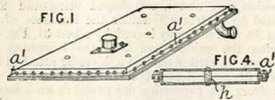

Heating water.—In water-heaters or boilers of the kind described in Specification No. 4250, A. D. 1904, the trays or casings are formed of stampings instead of cast metal. The stampings are provided with perforated flanges a' by which they may be riveted or bolted together. One stamping may be flat as shown in Fig. 1, or both plates may be dished as shown in Fig. 4. Stays h may also be provided. Various forms of trays are shown in the Specification. In the Provisional Specification it is stated that the heater may be used in conjunction with the apparatus described in Specification No. 7770, A. D. 1905.

20,463. Aspinall, F. B. Oct. 10.

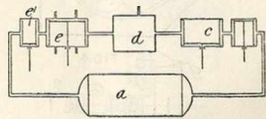

Heating water by exhaust steam on its return to the boiler. The exhaust steam passes from the low-pressure cylinder c to a receiver d, where it is partly condensed. The uncondensed steam is drawn off by the pumps e, e', which also act as compressor and boiler-feed pumps, also water from the condenser and hot-well, and, if necessary, "make up" water, are injected into the pump e'.

The exhaust steam is compressed in the presence of this water and returned to the boiler *a*. A hot-water supply may be obtained by introducing additional water into the pump *e*.

20,470. Sandbach, W. Oct. 10.

Heating liquids.—Heating or cooling coils or drums are suspended in a milk, cream, or other vat. As shown in end elevation in Fig. 1, the coils *c* are suspended from trolleys *d* arranged to reciprocate on rails at the ends of the vat by means of connecting-rods *n* attached to sprocket chains *l* which are continuously driven through suitable gearing.

[Reference has been directed under Patents Act, 1902, to Specification No. 21,969, A.D. 1904.]

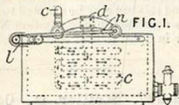

20,893. Davidson, S. C. Oct. 14.

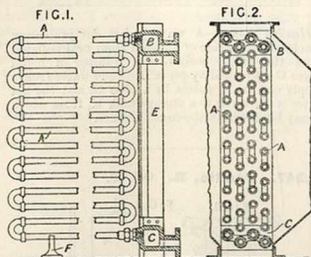

Heating gases and liquids.—Surface apparatus for use in heating or cooling fluids consists of sections formed of sinuous pipes arranged in quincunx and connected to inlet and outlet chambers supported by a vertical pillar, the sections being readily dismantled for transit. One section, shown in Fig. 1, consists of the continuous piping A connected by screw unions to inlet B and outlet C supported by a pillar E and stool F. Several such sections may be arranged side by side as shown in Fig. 2, so that the pipes of one section alternate with the spaces between those of the adjoining sections. A casing may be attached to the pillar E for the passage of air or other fluid between the pipes.

20,966. Bishop, R. C. Oct. 16.

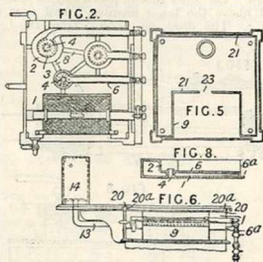

Heating water.—A boiler for gas stoves, ovens, hot-plates, and the like consists of a flat chamber 1, which may constitute the top of an oven. The boiler is formed with recesses 2, in which the burners 3 are placed, and channels 6, in which the gas pipes lie, cross-channels 8, which connect the recesses, allowing the products of combustion to escape should one of the recesses be covered by a vessel placed over it. A bay 9 is adapted to receive the grill-pan and grid. Air-tubes 4 passing through the boiler feed the burners, the radiant heat from which heats the water. The channels 6 slope downwards towards a gutter 6^a which collects any liquid boiling over from utensils placed over the burners. The underside of the boiler is formed with lugs which rest within ribs 21, Fig. 5, on the top of the oven, the upper part of the boiler also having lugs 20^a, Fig. 6, which are bolted to lugs 20 on the top of the range. A small space 23 is left to allow air to pass under the boiler to the air tube 4. The boiler is connected by circulating-pipes 13 with a hot water cistern 14, supported on an extension of the range top, beneath which the combustion gases from the oven are allowed to pass.

21,063. Geipel, W. Oct. 17.

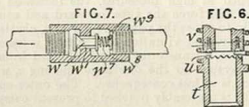

Steam traps.—Relates to improvements in the form of steam trap described in Specification No. 21,571, A.D. 1894, and consists (1) in arranging the discharge valve in such a way that it opens against the effluent water and steam; (2) in the prevention of chattering and scoring of the valve face and seat by an additional throttling device; and (3) in providing automatic means for

operating the lever by which the trap is blown through. The inlet tube *a*, preferably of brass, is placed above the lower member *b* and near the frame *c*. The discharge passage from the brass

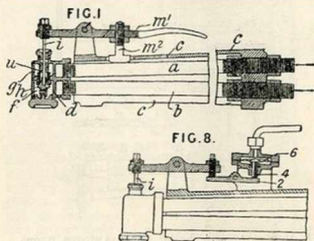

tube is formed in the valve casing *d* such that the escaping water passes to the lower chamber *f*, which contains the valve *h*. The valve thus opens against the water and steam when the expansive action of the trap comes into operation and raises the seating from the valve. The effluent is conveyed by a suitable passage in the casing from the chamber *g* to the lower hollow member *b* of the trap, from which it escapes in the ordinary manner. The valve is loosely fitted upon the spindle *i*. The arm *m*¹ of the hand-lever may, if desired, rest against a fixed stop on the frame *c* to limit its downward movement. In order, however, to utilize the upward movement of the tubes due to contraction, and thereby to increase the opening of the valve, one of the tubes, such as *a*, is made to act against the arm *m*¹ through a rigid rod *m*² and to push the valve from its seat at the time when the seat is moving away from the valve. Fig. 6 shows the throttling device in detail as applied to the valve casing *d*, and Fig. 7 when situated in one of the arms of the trap. It comprises a flanged tube *t* arranged to slide in a seat and normally held in place by a spring in its fully opened position. When the water is being discharged at high pressures, the increased fluid friction will force the tube outward and cause it partially to close the passage. By this chattering of the valve and vibration of the trap is lessened. In addition, a transfer of wear is effected from the valve aperture to the discharge opening *u*, where the wear is of less consequence. The outer end of the tube is preferably notched to prevent complete closure. A renewable wearing piece or stop *v* may be fitted. When the throttling device is transferred to the outlet branch, as shown in Fig. 7, it takes the form of a cone-valve *w* which controls a constructed passage in the tube. The valve is formed with the extension *w*¹ and with the plate *w*² against which presses the spring *w*³, having as an abutment the perforated plate *w*⁴. Instead of arranging the arm *m*¹ of the hand-lever to be operated by the expansion tube *a*, as in Fig. 1, or

arranging it to bear against a fixed support, it may, as in Fig. 8, be operated through the lever 2, which in its turn is acted upon by the rod 4. The upper side of the diaphragm 6 (or piston) is open to the pressure of the steam which fills the arm *a* of the trap. The position of the arm against which the stem *i* of the valve acts will be automatically varied upon variation in the steam pressure to which the trap is subjected, as in the traps described in Specification No. 21,783, A.D. 1897. The valve and its stem may be adapted to rotate intermittently as described in Specification No. 24,518, A.D. 1901, or in Specification No. 16,439, A.D. 1905.

21,237. Kellor, G. Oct. 19.

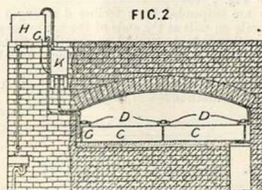

Heating water.—A water-jacket for protecting articles near the side of an oven from heat radiated from the walls consists of a number of metal boxes *C* connected by pipes *D*. Cold water from a supply cistern *H* enters by a pipe *G*, and the hot water is delivered to a storage tank *K*, from which it may be drawn in the usual manner.

21,247. Tomlin, B. Oct. 19.

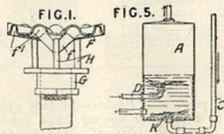

Heating water; heating by water circulation.—The cold-water supply pipe *C* and the hot-water flow pipe *D* are furnished, within the tank *A* of a domestic water-heating system, with spreaders *K*, to prevent the mixing of the entering currents. The spreaders consist of bosses *G*, Fig. 1, which are secured to the ends of the pipes, each carrying, by means of rods *H*, a plate *F*, which is preferably formed with a central depression *f* and radial corrugations *f*¹, which break up and distribute the entering liquid.

1905]

ABRIDGMENT CLASS HEATING.

21,431. **Leyson, S G.** Oct. 21.

Heating liquids.—Relates to apparatus for heating, cooling, sterilizing, filtering, and storing liquids, particularly applicable for the provision of purified drinking water. The water &c. is boiled by means of an electric heating-coil 26 in a pan situated in the upper part of the storage tank 1.

FIG. 2

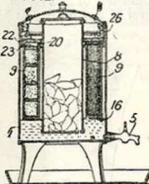

21,444. **Kaerle, F.** July 17, [date applied for under Patents Act, 1901].

Heating buildings &c.—In an electromagnetically-operated valve for use in heating-apparatus, the electromagnet is arranged, as shown in Fig. 1, close to the valve in a separate chamber isolated from the valve chamber by a fluid-tight partition S of mica. In a second arrangement, the valve works horizontally and has a similar operating device on each side. The valves are put into operation by means of a contact-thermometer when certain temperatures are attained.

FIG. 1.

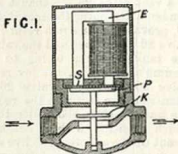

21,445. **Kaerle, F.** July 18, [date applied for under Patents Act, 1901]. Void. [Published under Patents Act, 1901.]

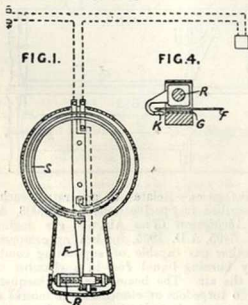

Thermostat.—A bimetallic thermometer is arranged to complete an electric circuit when a

certain maximum or minimum temperature has been reached. A metallic spring F, Figs. 1 and 4, attached to the free end of the bimetallic spring S, moves laterally over the smooth non-conducting surface G, Fig. 4, and the circuit is completed when the spring touches the contact-strip K, the position of which can be adjusted for any required temperature by means of the screw R. To ensure reliable contact, the strip K projects above the level of the surface G.

21,497. **Heide, H. C.,** [Kilborn, H. M.]. Oct. 23.

Heating water.—A device for regulating the supply of gas to the burner of a water-heater, preferably of the kind in which the water is under pressure, as in a coiled tube, by means of the flow of water, comprises an upper water chamber 9 and a lower gas chamber 5. When water is withdrawn from the heater, cold water entering the upper chamber beneath a piston 17, which is prevented from turning by ribs 18 on the inner face of the chamber fitting in grooves in the piston, raises the latter and passes to the heater by the outlet 16. The raising of the piston turns a threaded spindle 19, upon which it is fitted, and the motion is communicated by means of an intermediate spindle 23, provided with a flattened end fitting

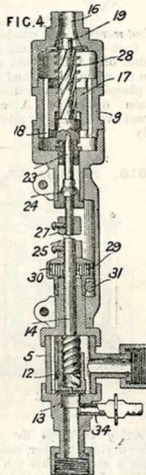

in a recess in the end of the spindle 19, to a lower spindle 14, to which it is loosely coupled as shown at 25, 27. The end of the lower spindle is also threaded, and is fitted with a valve 12, which is prevented from turning and serves to open or close the gas inlet 13. When no more water is withdrawn from the heater, the piston 17 may descend by its own weight so as to close the gas valve, but preferably a spring 28 is fitted on the spindle 19 to assist the descent. A spiral spring 23, attached at one end to the spindle 14 and at the other end to an enclosing case 30, may also be employed, the tension of the spring being adjusted by a worm 31 engaging a thread on the casing 30. The lower end of the spindle 23 is provided with a shoulder 24, and the space around the spindle may be provided with a self-lubricating packing of

heavy grease, such as vaseline. A pilot passage 34 to the gas burners may be provided.

21,598. Aldington, G. Oct. 24.

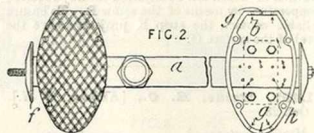

Foot-warmers.—A combined silencer, foot-rest, and foot-warmer for use on motor road vehicles consists of a tube *a* into which pass the exhaust gases from the motor, and two chambers *b* which are placed over the outlet orifices *h* and which contain outlets *g*. A valve *f* is provided to prevent overheating by allowing the gases to escape freely.

21,816. Hughes, W. B. Oct. 26.

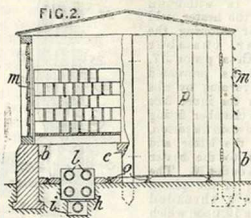

Heating buildings &c.—Where a brick and timber drying-chamber, such as is shown, is erected within a shed so that the hot air escapes through the sides of the chamber into the shed, the upper part of the latter is used for heating or drying.

21,822. Taylor, J. H. Oct. 26.

Steam traps.—Relates to that class of apparatus for automatically returning water of condensation to boilers in which a counterbalanced receptacle is adapted by its movements to operate valves, and comprises among other things the provision of an automatic vent valve for reducing the pressure in the receptacle. The receptacle 2, fitted with a water gauge 3, is mounted and guided in a frame 1, being counterbalanced by weights 13 as shown. Communication with the receptacle is made by two flexible pipes 18, 19, connected to a partitioned chamber 14 secured to the bottom of the receptacle.

A lever 31 pivoted at 30 is attached to the tank and operates the valve 20 which controls the admission of live steam. A lever 32, connected to lever 31 and pivoted at 33, actuates the spindle 27

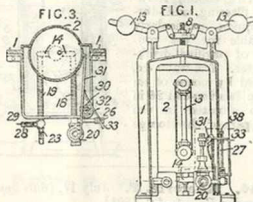

of a vent valve 26. Exhaust steam and water of condensation enter the receptacle through the pipe 19, provided with a non-return valve 23, the vent valve 26 being open and the valve 20 closed. When the tank descends owing to the weight of the accumulated water, the levers 31, 32 operate the valve 20 and vent valve 26, respectively, thus admitting live steam to the receptacle and forcing the water back to the boiler through the pipe 28, which is fitted with a check valve 29. On the ascent of the cylinder, the live steam is shut off and the vent valve is opened, thus reducing the pressure in the tank and again permitting the entrance of the exhaust steam and water. By means of the nuts 8, 38, the position of the weights 13 and the valve 26, respectively, may be adjusted.

21,936. Armstrong, Whitworth, & Co., Sir W. G., Lloyd, E. W., and Sodeau, W. H. Oct. 27.

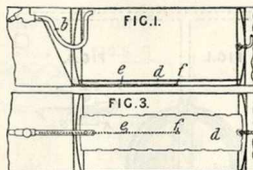

Heating gases.—Relates to apparatus, such as that described in Specifications No. 25,003, A.D. 1904, [Abridgment Class Air and gas engines], and No. 3495, A.D. 1905, for heating compressed air or other gas capable of supporting combustion, by burning liquid fuel in a chamber containing the air. The heated air is subsequently applied to torpedoes or elsewhere for motive and other purposes. In order to prevent the accumulation of fuel in the air reservoir, a draining-tube *e*, which may be provided with a strainer *f* at its

lower end, is connected at its other end to the pipe *b* conveying the air from the reservoir, so that the fuel is withdrawn by the suction of the outgoing air. To hinder the combustion of any accumulated fuel, in case the above-described device fail, a screen or false bottom *d*, provided with holes or gaps which may be covered with wire-gauze, is arranged to divide the lower part of the combustion chamber from the body thereof.

21,995. **Reeve, S. A.** Oct. 28.

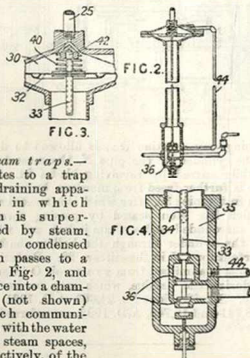

Steam traps.—

Relates to a trap for draining apparatus in which steam is superheated by steam. The condensed steam passes to a trap, Fig. 2, and thence into a chamber (not shown) which communicates with the water and steam spaces, respectively, of the boiler. The chamber contains a float-operated valve controlling the inlet of condensed steam from a separator. The discharge valve 36, Fig. 4, of the trap is controlled by a diaphragm 32, Fig. 3, to which it is connected by a tubular spindle 33. The upper side 30 of the diaphragm communicates with the low-pressure main and with the valve chamber 35 by the pipe 44 and the spindle 33. The lower end of the spindle 33 has a lateral outlet 34, and the upper end forms a valve 42. A spring 40 tends to keep the valve 36 in the closed position. When the water accumulates sufficiently to close the opening 34, the space 30 is shut off and its pressure reduced by leakage past a valve in the pipe 25. The diaphragm 32 then opens the valve 36 and allows the water to pass from the chamber 35 to the float chamber. The pressure created in this chamber closes a valve, and the water from both high and low pressure mains is returned to the boiler.

22,125. **Tejada, J. de D.** Oct. 30.

Heating-apparatus; heating gases and liquids.—
Powerful explosives are fired in small quantities in a chamber, and the resulting gases act directly on

the piston of an engine or are conveyed to a storage chamber and used for generating steam, driving air engines, or for other purposes. The gases may heat air, water, or other substances by

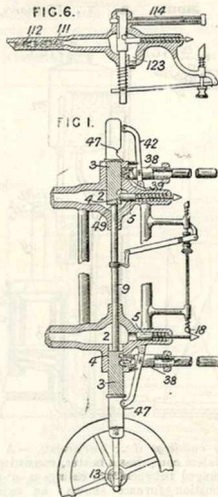

passing through a coil surrounded by them; the excessive heat generated in the explosion chamber may be variously employed, e.g. the chamber may be immersed in the feed-water tank of a steam-generating apparatus. The apparatus employed comprises a chamber 2 in which which works a piston 3 with a cavity 49 for receiving an explosive from a feeder 38 and an anvil 4 on which the hammer 5 impinges for exploding the charge. The piston and hammer are expelled by the explosion; the former may drive a crank-shaft 13, the latter is arrested by a spring catch 18 controlled from the piston-rod 9. Liquid explosives are supplied from a saturated absorber 39, Fig. 1, which is pressed against the anvil at the end of the out-stroke when the end of the lever 42 enters the notch 47 in the piston. Solid explosives as shown in Fig. 6 are supplied in the form of disk-shaped cartridges 114, the cases of which collect in the chamber 123. When the explosion gases are stored, they pass numerous valves 111, 112 on their way to the storage chamber. The chamber 38 containing the absorber may be ventilated for the escape of any gases that may pass along the piston, and the absorber may be withdrawn from the chamber 38 and swung aside during the explosion or a transverse sliding valve may come between it and the piston. The

liquid explosive may be supplied through flexible piping to prevent the transmission of jar to the reservoir.

22,240. Bolt, A. J., [*Lamarre, H.*], Oct. 31.

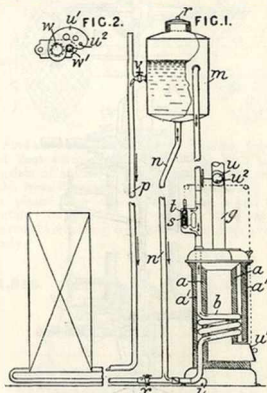

Heating buildings &c.; thermostats.—A water heating-system comprises a heater, consisting of a coil *b* arranged between two casings *a, a'* of the slow-combustion furnace shown; an expansion chamber *m* closed air-tight by a luted lid *r*, and communicating with the boiler flow-pipe *n* and the radiator-supply pipe *p*, and having also a connexion *n* with the boiler inlet *i*, and a thermostatic regulator consisting of a thermometer *s* and a float *t*, the motion of which controls a damper *u* in the furnace flue *a*, or a register *u'* which controls the air-supply. A small hole *u''* in the damper prevents complete interruption of the draught. The register *u'* is constructed as a plate pivoted at *w*, and perforated with a series of holes *w*. Circulation is first set up by closing the cocks *v, x*, which are subsequently opened to allow the water to pass through the whole system. Two or more heating-coils having separate expansion vessels may be employed with the same furnace.

22,241. Haddan, H. J., [*Edson Reduction Machinery Co.*]. Oct. 31.

Digesters for extracting oil &c. from vegetable or animal matter. The material is fed into the cylinder *A* through the upper dome *a*, and steam under pressure is supplied to the jacket *B* by the pipes *d*, boiling being prevented by putting the cylinder in communication with a compressed-air

reservoir *G*. The liberated oil rises in the dome *a* and flows off by the pipe *K* to a tank *J*, this being expedited by pumping in water through the pipe *L*. When all oil has thus been led away, the water,

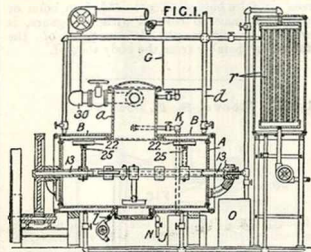

containing any gelatine &c., is allowed to drain from the cylinder by the pipe *N*, the mass being meanwhile stirred by revolving blades *22*. The residue is further freed from moisture by creating suction in the pipe *30*, after which it is treated with air which has been heated by passing through pipes *r* surrounded with a steam jacket, and which enters the cylinder through the hollow shaft *13* and perforations *25* in the stirrers *25*. Preferably also, ozone is admitted from a reservoir *O* in order to deodorize the residue, which may be used as food &c. Specifications No. 24,603, A.D. 1901, and Nos. 18,741 and 18,743, A.D. 1902, are referred to.

22,242. Haddan, H. J., [*Edson Reduction Machinery Co.*]. Oct. 31.

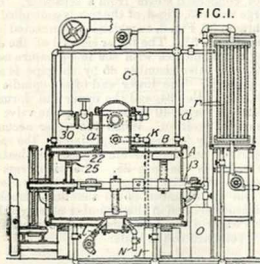

Digesters for extracting oil &c. from vegetable or animal matter. The material is fed into the cylinder *A* through the upper dome *a*, and steam under pressure is supplied to the jacket *B* by the pipe *D*, boiling being prevented by putting the

cylinder in communication with a compressed-air reservoir G. The liberated oil rises in the dome a and flows off by the pipe K to a tank J, this being expedited by pumping in water through the pipe l. When all the oil has thus been led away, the water, containing any gelatine &c., is allowed to drain from the cylinder by the pipe N, the mass being meanwhile stirred by revolving blades 22. The residue is further freed from moisture by

creating suction in the pipe 30, after which it is treated with air which has been heated by passing through pipes r surrounded with a steam jacket and which enters the cylinder through the hollow shaft 13 and perforations 25 in the stirrers 22. Preferably also, ozone is admitted from a reservoir O in order to deodorize the residue, which may be used as food &c. Specification No. 18,741, A.D. 1902, is referred to.

22,246. Carlberger, L. Oct. 31.

Heating by water circulation.—Water for heating a series of incubators and foster-mothers is heated in tanks 1 attached to each incubator and circulated by a pump A. The water passes from the pump A to a tank 38 and thence by a pipe 43 to the tanks 1, each of which is provided with its own heating-appliance and thermostat, thence by pipes 21 to heating-tubes 6, 15 for the incubators, vaporizing-tanks 16, and hatching-out chambers 17, thence by pipes 50, 51, 52 to the tank 39, and thence to the foster-mothers. These consist of tube neaters 24, arranged in tiers in frames 23. The water enters and leaves by the double pipes 25, and by opening the taps *b, b', b'', c, c', c''* the heaters may be connected in parallel, and by opening the taps *b, d, e', e''* they may be connected in series. The water passes from the foster-mother by the pipe 56 to the tank 40 and thence back to the pump A. Overflow pipes 41 lead from the tank 38 to the tank 39 and from the latter to the tank 40. Water is also supplied from the tank 38 to actuate certain mechanism connected with the incubators, and returns to the tank 39.

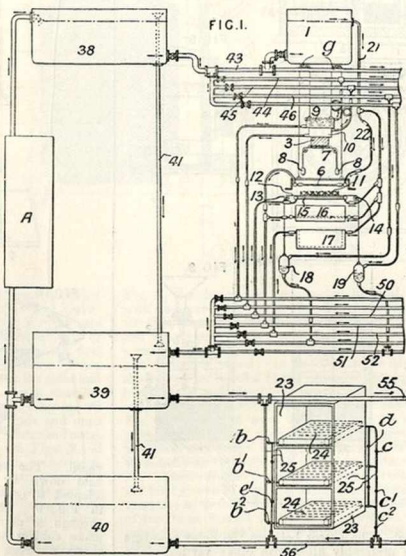

22,314. Berry, A. F. Nov. 1.

Heating by electricity; heating liquids; bed-warmers; footwarmers.—Relates to electric apparatus for heating or cooking liquids &c., in which the heat is generated by induced currents in secondary conductors located adjacent to the primary conductors. The secondary conductor is

formed by one or more solid metal rings or frames, each closed permanently upon itself and arranged within or close to the cooking vessel &c., so as to be co-axial with the primary conductor. The circuit of the magnetic core extends through both the primary and the secondary conductors, and is formed partly by magnetic material arranged within or extending through the vessel. The magnetic core

may be partly constituted by the vessel itself. In the arrangement shown in Figs. 1 and 2, a vessel rests partly within the stationary part of the magnetic core 1. This core, as shown in Fig. 3, consists of plates arranged radially with their flat sides

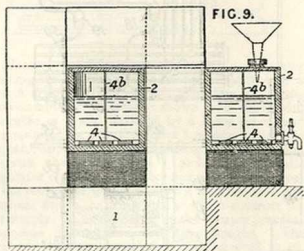
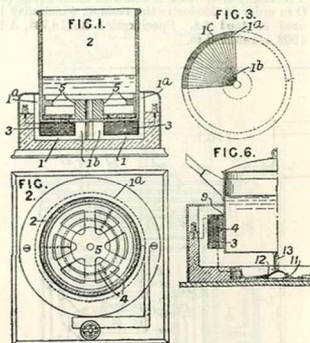

Asbestos or similar material 9 may separate the heater from the primary coil. Fig. 9 shows an annular liquid-container 2 having the magnetic core 1 extending through the centre of the

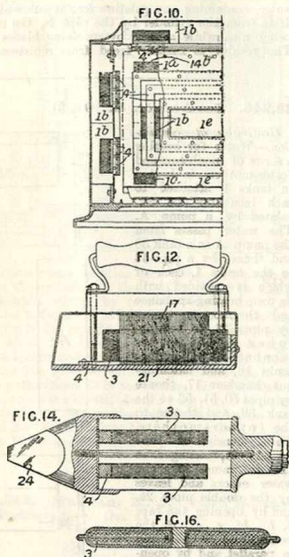

vertical. The spaces between the outer members 1^a are preferably filled with other vertical strips 1^b. The primary conductor 3 is wound in a circular recess formed by the inner and outer members 1^a, 1^b of the core. The secondary conductor 4, which is placed in the bottom of the vessel, consists of concentric metal rings which may be connected by radial bars. These bars are fixed to the underside of the rings so as to support them and allow liquid to pass below them. The rings are held in position by a circular iron casting 5 of double Γ section which also completes the magnetic circuit. The heater and primary coil may extend around the outside of the vessel near the lower edge as shown in Fig. 6. Or the heater may be fixed to the bottom of the vessel.

vessel. The secondary conductors 4 may be held down by rods 4^b. The vessel may be adapted to open and close the circuit as shown in Fig. 6. The vessel by its weight acting through a plunger 13 forces a spring 12 to make contact with a fixed contact 11. Fig. 10 shows an oven or stove having heaters arranged at the sides and top. Two laminated magnetic cores 1^a, 1^b extend into slots 14^b in the non-conducting walls, the primary coils bearing against the portions of the wall between the slots. The magnetic circuits are completed by iron plates 1^c inside the oven. The secondary conductors consist of closed flat metal frames 4 arranged one within the other. Fig. 12 shows a sad-iron. A continuous recess in the magnetic core 17 receives the primary coil. An iron-plate 21 serves as the heating-surface and also completes the magnetic circuit. A separate secondary conductor 4 may be placed in the recess containing the primary coil. Fig. 14 shows a soldering-iron, the primary coil

being disposed in a recess in the magnetic core. A separate secondary conductor 4 may be interposed between the copper cap 24 and the primary coil. Fig. 16 shows a bed-warmer consisting of

two iron plates connected at their edges and also at their central portions so as to form an annular space for the primary coil 3. A footwarmer may be constructed in the manner shown in Fig. 16.

22,316. **Jarvis, G. F.** Nov. 1.

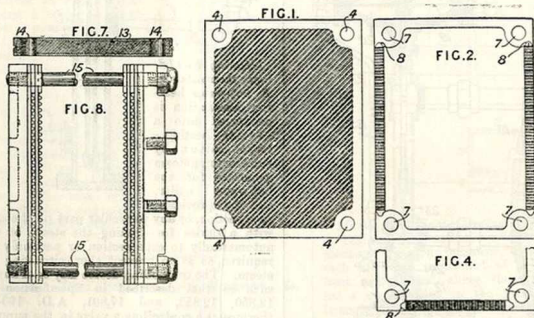

Heating gases and liquids.—Relates to surface apparatus for heating in which indented or corrugated metal plates with plain flat margins are placed together, surface to surface, in contact or nearly so, the chamber formed between the first pair of plates having a distance-frame placed between its edges to close the edges at the sides and leave the same open at the ends, and the chamber formed by the next superposed plate having its edges closed by the frame at the ends and open at the sides, and so on. Each distance-frame, alternate forms of which are shown in Figs. 2 and 4, is constructed with a hole 7 at each corner coinciding with holes 4 in the plain margins of the corrugated plates, so that clamping-bolts can be passed through the holes in the plain distance strips and through the holes in the plates. Each distance-frame is formed of four separate strips. Two opposite strips are formed of flat sheet metal equal in thickness to the distance between the plain margins of the corrugated plates. The other two strips are made of thinner corrugated metal and fit into recesses 8 formed in the plain flat strips. To lessen the weight of the clamping-plates shown in

Fig. 7, the latter are constructed of steel cased with non-corrodible metal 13. They are made of the same size as the corrugated plates and frames and are formed with corresponding holes at the corners. These holes are lined with tubes 14 of non-corrodible metal. In assembling the parts, as shown in Fig. 8, bolts 15 are threaded through the holes of an end clamping-plate. The plain side strips of a distance-frame of the kind shown in Fig. 4 are threaded over the bolts, and the corrugated end strips are then fitted in the recesses of the plain side strips. A corrugated plate is next threaded over the bolts and placed in contact with the distance-frame. Another distance-frame of the kind shown in Fig. 2 is then placed adjacent to the plate so that its plain members form the ends of the frame instead of the sides as before. Distance-frames separated by corrugated plates are thus alternately arranged, the corrugation of the successive plates being in opposite directions. The bolts finally pass through a second clamping-plate, and the two clamping-plates are then drawn together by nuts so as to clamp the margins of the corrugated plates and frames tightly together.

22,383. **Barker, G.** [Noyes, E. P.]
Nov. 2.

Steam traps.—The movement of a diaphragm actuating a valve or an alarm is controlled by the

differential action of constant and varying pressure derived from a vessel containing a liquid and gas under pressure. As shown applied to feeding a boiler 10, the device consists of a diaphragm 19 forming the two compartments 20, 21, the former

being in direct communication with the steam space. The diaphragm carries a hollow rod 22, the lower end of which terminates at the desired water level. Its upper extremity opens into the chamber 21

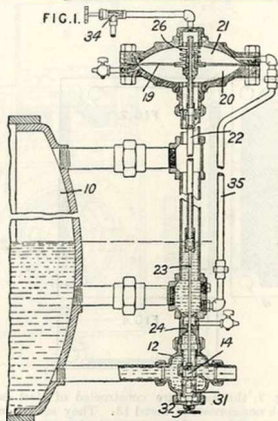

provided with a vent valve 34 which permits a slight leakage. The spindle 23 of the feed-valve 14 is screwed to the tube 22, and, by means of the claw 31, rotatable by the hand-wheel 32, the lift of the valve may be adjusted. The valve casing 12, with the exception of the valve seats, is symmetrical about its central horizontal axis so that when reversed the valve may act as a by-pass if desired instead of as a direct feed-valve. The partition 24 is cone-shaped on both sides to prevent the accumulation of sediment at the centre of its upper side and to facilitate the guiding of the spindle to the aperture when the parts are being assembled. The spindle machine fits its aperture in the partition and is thus hydraulically packed. The action of the apparatus is as follows:— When the level falls, the lower end of the tube 22 is exposed and the pressures in the chambers 20, 21 are equalized, thus allowing the spring 26 to depress the diaphragm and tube 22 and open the valve 14. As the end of the tube is thus again sealed, the leakage of the vent valve 34 causes a diminution of pressure above the diaphragm, which consequently rises and closes the valve 14. The pipe 35 carries back to the boiler any water forced up the tube 22 into the chamber 21. The apparatus may be employed as a gas or liquid trap or may control the height of a water seal.

22,451. Nesbit, D. M. Nov. 2.

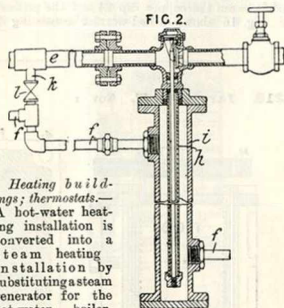

Heating buildings; thermostats.— A hot-water heating installation is converted into a steam heating installation by substituting a steam generator for the hot-water boiler, and by providing each section, or any particular part of the system, with a device for feeding the steam or vapour automatically to each section or part only as it is required, so as to prevent short-circuiting of the steam. The controlling-device may be of any form, such as that described in Specifications Nos. 12,850, 12,852, and 17,801, A.D. 1904. A thermostat *h* controlling a valve in the supply pipe *e* may be enclosed in a jacket *i* into which the return pipe *f* is led. The jacket may be provided with external and internal strengthening-ribs formed in the manner described in Specification No. 6320, A.D. 1904, [Abridgment Class Boxes &c.]. The lower part of the jacket may lead to a mud box or dirt catcher, such as that described in Specification No. 6938, A.D. 1905, [Abridgment Class Steam generators]. Where necessary, the supply mains may be inclined so that the water of condensation follows the same course as the steam; or a drain connexion *k*, fitted with a thermostatic valve *l*, may lead from the supply main to the return main. The discharge of the vacuum pump, to which the jacket *i* is connected, may be collected in an elevated tank, where the air is separated, and returned to the boiler. In converting systems in which one main serves both for flow and return, the discharge from the radiators may be led to a common return pipe leading to the vacuum pump or condenser. Specification No. 12,944, A.D. 1902, is also referred to.

22,452. Stone & Co., J., and Darker, A. H. Nov. 2. Drawings to Specification.

Heating air.— Air for ventilating railway carriages, ships, or other vehicles is heated by passing it through a chamber containing a steam coil or other heating-apparatus.

22,805. Mackay, R. Nov. 7.

Heating water.—Apparatus for heating water by steam. An outer casing, having a water inlet *b* towards its lower part and a hot-water outlet *f* at some distance below the top of the apparatus, encloses an inner closed casing *c* having a steam inlet *d* towards its upper end. An inner tube *e* conducts the steam from near the bottom of the inner casing to near the top of the outer casing, so that steam and water mix before leaving the outlet *f*. The outer casing may be of smaller diameter at its upper part and terminate with an enlargement or dome. The inner casing occupies the lower part of the outer casing only.

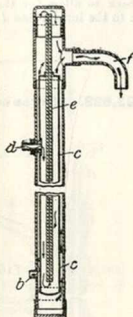

23,117. Smirlan, J., and Lagües, L. Nov. 10.

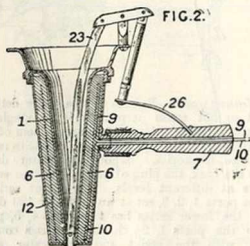

Heating by electricity.—Sealing-wax or other substance is melted in a conical pot 1, Fig. 2, surrounded by a heating coil 12 of german-silver wire in an asbestos coating 6. The electric leads 9, 10 pass out through the handle 7 and are connected by flexible wires &c. to the ordinary house circuit. When in use, the container is held over the article to be sealed &c. and the plug-valve 23 is lifted by depressing the spring 26 attached to the handle. According to the Provisional Specification, a shunt circuit may be used, controlled by a switch, to reduce the consumption of current, and the heating effect, between the intervals of use.

23,141. Mennesson, G. Nov. 28, 1904, [date applied for under Patents Act, 1901]. Void. [Published under Patents Act, 1901.]

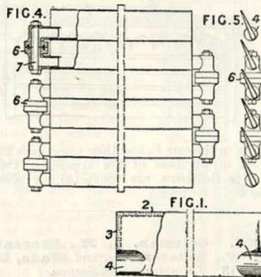

Heating buildings; heating gases and liquids.—A radiator for heating, applicable to heating by means of "vapour pulsators," consists of elements each of which is formed of a thin metal plate bent and united along its edges 2 so that it has a cross-section in the form of an elongated triangle with a rounded base. The ends of each element may be stamped or pressed to form cylindrical portions 4, for tubular connexions, and flat portions 3 which are soldered together. The elements may be arranged one above the other, with their rounded portion lowermost, in lower fashion. The cylindrical portions 4 of the elements are connected at alternate sides by elbows 6. The elements are held together by bolts 7 and nuts. To avoid stamping or pressing the ends of the elements, these ends may be provided with cast metal connecting-boxes.

23,272. Board, H. C. Nov. 13.

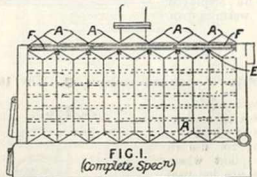

Heating water, boilers for. Arched deflectors *a*, Fig. 2, of the Provisional Specification, are placed over the boiler tubes *c* to baffle the flame &c. passing to the flue *b*. They may be fitted so as to

enclose and form the casing of a portable boiler, as shown in Fig. 1 of the Complete Specification. In this apparatus, the side deflectors A are connected

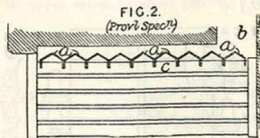

by bolts in the ears E, and their lower ends fit into rabbets in the base of the apparatus; the top and side deflectors are connected by shoulder pieces F

23,307. Coleman, J. M., Stevenson, A. W., Sclater, W., and Wade, C. E.
Nov. 13. *Drawings to Specification.*

Non-conducting coverings and compositions.—Consists in the general application to railway and other vehicles of a plastic mineral composition to render the vehicles fire-proof and non-conductive of electricity and heat. The composition preferably consists of a mixture of asbestos fibre and cement, moulded under pressure to the shape required, the form adopted for panelling consisting of slabs, ornamented or grooved to resemble wood-work, if desired, and having overlapping edges.

23,454. Grossi, C. Nov. 15.

Bed-warmers.—A hollow hand-iron of the shape shown in Fig. 1, adapted to be filled with hot water, and chiefly intended for use in ironing, may also be employed as a warming-pan.

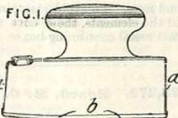

23,567. Sennsrenbrenner, C. Nov. 16.

Heating water.—Relates to concentric serpentine tubing for use in any plant where fluids are led past one another to effect an interchange of heat, such as feedwater-heaters. The

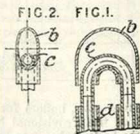

tubes are connected together by bends *b, c*, welded to the tubing, the outer bend *b* being formed oval or of other cross-section so that it may be drawn back to allow for the welding of the inner bend *c* to the inner tubes *d*.

23,623. Gugenheim, L. Nov. 16.

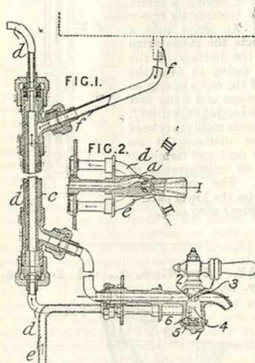

Heating water.—Relates to means for delivering cold or hot water at pleasure by a single cock, capable of being interposed in any system of steam heating-pipes, more particularly for use in railway-carriage lavatories. Upon the water-delivery pipe is a cock, the plug of which has two series of ports at different levels. The upper series has three ports 1, 2, 3, set at an angle of 120 degrees, and the lower series has two ports 4, 5, parallel with the ports 1, 2; the upper series communicate with the spout and the water supply, and the lower series with the steam supply. When the handle is in the position I, neither water nor steam can pass through the valve. When it is in the position II, the ports 1, 2 are connected to the water supply, but no steam passes, and cold water is delivered; when it is in the position III, water is delivered through the ports 1, 2 and steam passes from the pipe *d* through the lower ports up the pipe *e*, thus heating the water passing through the jacket *c*. A groove 6 in the valve allows any condensed water to escape, when the cock is closed, into the chamber 7, whence it passes through a hole.

23,635. Thomas, A. Nov. 16.

Heating water; thermostats.—The supply of gas to the burner *j* heating a steam generator *b* is regulated according to the pressure in the generator. As the pressure rises, water is forced up the pipe *a* into a water seal *d* to the gas supply. The gas pipe projecting into the seal may terminate in a slit so that the supply is cut off gradually. A by-pass *o* serves to keep the burner lighted. If the boiler pressure rises suddenly, water passes over into another water-seal and entirely cuts off the gas supply. In the Provisional Specification, the invention is also described in connexion with a water circulating boiler.

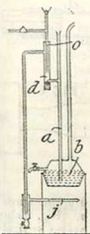

23,697. Wilson, C. W. Nov. 17.

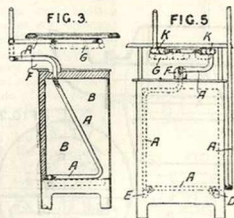

Heating by water circulation; heating buildings; heating water.—Relates to a hot-water heating-system in which the water is heated by the waste heat of cooking-stoves, kitchen ranges, and the like heated by gas, oil, or electricity. A pipe or pipes *A* from the water-circulating tank enter the oven *B* near the front of the stove. The pipe *A* passes over the first set of oven burners *D*, along the back of the oven, and over the second set of burners *E* which are at the other side of the oven. It then rises, preferably in a slanting direction, close to the side of the oven, and passing along the roof thereof and through the flue *F* is carried over the hot-plate burners *G* back to the circulating tank. The pipe may have a hinged connexion *K*, so that it may be lifted clear of the burners *G*. The circulating pipe *A* may be connected to the ordinary hot-water circulation of a kitchen range and form an auxiliary system of hot-water supply when the kitchen range is not in use.

23,929. Ogden, J. E. L. Nov. 18.

Steam traps.—In that class of steam trap comprising a tube *a* enclosing an expansion tube *g* carrying a valve seat *h* and being screwed into a diaphragm *d* separating the inlet chamber *e* from the outlet *f*, a sump-like part is provided in the inlet chamber so that the tube *g* receives the coolest portion of the water of condensation. The valve and its seat may be of the form described in Specification No. 285, A.D. 1904, and a pin *o* determines the extent of movement of the lever *m* spring-pressed upon the valve spindle. The capacity of the expansion tube *g* is reduced by the rod *q* as described in Specification No. 12,875, A.D. 1904. The pin *o* may either rest on a fixed portion of the casing, or, as shown in the Figure, on the cap of a compensating-tube *s* described in Specification No. 13,434, A.D. 1903. If the apparatus is employed in the horizontal position, the water is admitted to the tube *g* at its upper side only.

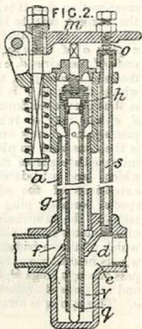

23,989. Cooper, E. H., [executor of Newton H. E.], (Kleeve & Co.). Nov. 20.

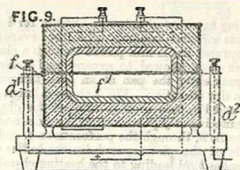

Heating by electricity.—The current of an electrically-heated furnace, stove, or other apparatus is automatically cut off at any desired temperature by the melting of a fusible wire or strip

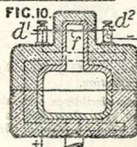

which carries the current and is exposed to the heat of the furnace. The wire *f*, which is of such cross-section that it is not heated by the passage of the current, may be held between the slit ends of two platinum or other metal wires *d, e* attached to a plug *a* of fire-clay, porcelain, or the like. The ends of the wires *d, e* may be provided with intermediate pieces *j, k*, as shown in Fig. 5, between which the strip *f* is held. The wire on melting is thus prevented from adhering to the metal wires *d, e*, and may be removed with the intermediate pieces *j, k*. A new wire with its intermediate pieces is then inserted in place of the melted wire. The intermediate pieces may be in the form of tubes which are introduced into split sleeve-shaped extensions of the wires *d, e*. Fig. 6^a shows a special form of plug for facilitating the replacement of the intermediate pieces. A body part *a* of chamotte is provided with two holes through which platinum-iridium wires pass. The fusible wire is held between two L-shaped pieces *j, k* which pass through rings *h, i* at the ends of the wire *d, e* and are pressed against the body part by a spring *n*. This spring is arranged between a handle piece

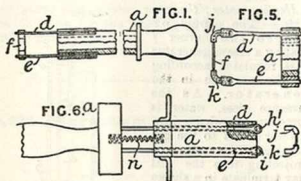

to which the wires *d, e* are attached and the body piece *a*. Fig. 9 shows a muffle in which the fusing wire passes entirely through the furnace and is connected to terminals *d', d''* outside the muffle. Fig. 10 shows a muffle provided with a dome or tower through which passes a fusing wire attached to terminals *d', d''* outside the dome.

24,186. Ray, G. R. Nov. 23.

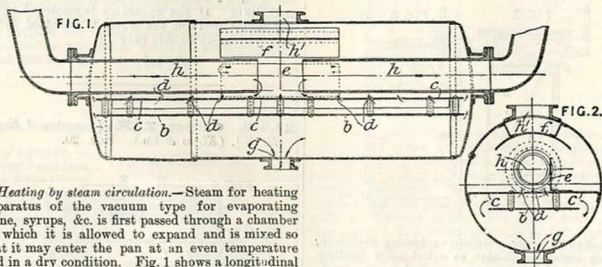

Heating by steam circulation.—Steam for heating apparatus of the vacuum type for evaporating brine, syrups, &c. is first passed through a chamber in which it is allowed to expand and is mixed so that it may enter the pan at an even temperature and in a dry condition. Fig. 1 shows a longitudinal section and Fig. 2 a cross-section of the chamber. Steam entering at *g* passes round the sides and ends of the baffle *b*, through the perforations *d*, and past the ends of the plate *c*, and by the baffles *e, f* to the passages *h, h'* leading to the heating-chamber of

the pan, which may be, for example, of the kind described in Specification No. 29,602, A.D. 1901, [*Abridgment Class Distilling &c.*].

24,272. Gill, J. Nov. 24. Drawings to Specification.

Heating buildings.—Relates to hydraulic apparatus of the type described in Specification No. 8753, A.D. 1905, [*Abridgment Class Pumps &c.*], in which

air or other gas is forced by a blower &c. through jets into a closed water circuit and is compressed and delivered into a reservoir. According to the Provisional Specification, the heated air obtained in the apparatus may be used for warming buildings.

24,347. Ruud, E., and Mullenbach, H.
 March 21, [date applied for under Patents Act,
 1901].

Heating water; thermostats.—A water heater, applicable to heating buildings and heating water in connexion with storage systems, has a series of water-heating elements consisting of serpentine pipes, arranged in a casing one above the other and separately connected to flow and return headers 3, 9, with or without a thermal regulating-apparatus. The headers 3, 9 may be connected to a storage tank 10. The gas supply to the burners 5 may be regulated by a thermostatic device, such as that described in Specification No. 16,482, A.D. 1898, and shown in Fig. 3, located in one of the water-heating elements or in a header. A closed tube 13, containing a rod 14 of a lesser degree of expansibility, actuates through levers 16, 17 a valve 15 in the gas-supply pipe. The valve 15 is normally held closed by a spring 18. A pilot burner 8, Fig. 1, is also provided.

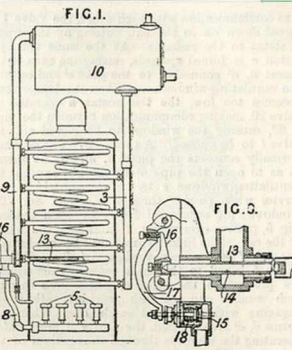

24,431. Chadborn, F. Nov. 25.

Thermostats.—Relates to apparatus for automatically controlling ventilation and heating by means of constant and variable fluid-pressure systems. As applied to a railway car, swinging windows *c* arranged along each side of the car are automatically operated for ventilation purposes by pivoted beams *d, d'*, through the medium of links *7, 5, r*. The inner ends of the beams *d, d'* are pivoted to a yoke *e'* carried by a piston-rod *e* terminating in pistons *12* working in cylinders *f, f'*. The smaller cylinder *f* is connected to the constant-pressure system by a pipe *g*, and the larger cylinder *f'* to the variable-pressure system by a pipe *h*. A thermostatic device *n* is designed to operate a valve *20* so as to make communication between the pipes *g, h* when the temperature is too high and between the pipe *h* and a waste pipe *22* when the temperature is too low. Branch pipes *g', h'* from the pipes *g, h* communicate with cylinders *k, i*, Fig. 2, fitted with pistons *k', i'* connected to a yoke *19* attached to a valve *1* which regulates the passage of steam through an outlet *18* to a radiator. The piston *i* is larger than the piston *i'*, so that, on a rise of temperature occurring and the pipes *g, h* being put

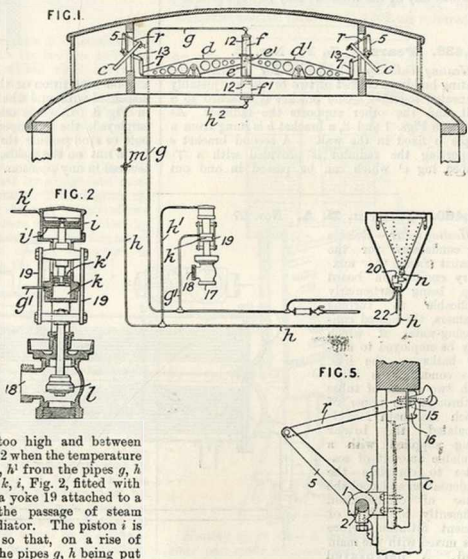

into communication with each other, the valve *l* is forced down on to its seat, cutting off the supply of steam to the radiator. At the same time the piston *e* is forced upwards, raising the ends of the beams *d*, *d'* connected to the yoke *e'* and opening the ventilating-windows *c*. When the temperature becomes too low, the thermostat *n* operates the valve 20, making communication between the pipes *h*, 22, causing the windows to be closed and the valve *l* to be opened. A three-way cock *m*, which normally connects the pipes *h*, *h'*, can be turned so as to open the pipe *h'* to the air, causing the ventilating-windows *e* to be closed, which is of service when passing through a tunnel &c. The windows *c* are suspended freely by open brackets Fig. 5, passing over shafts 2 extending the length of the car. The links 13 are keyed to the shafts at one end of the car where the beams *d*, *d'* are situated. Links 5 keyed to the shaft opposite each window are pivoted to the links *r*, which pass through each window and are each provided with a slot engaging with a pivoted catch 15. When the beams *d*, *d'* are operated, the shafts 2 are rotated, operating the windows through the medium of the links 5, *r*. The catches 15 also engage with notched plates 16 so that they can be turned and held out of engagement with the notches in the links *r*. In this way any of the windows may be kept closed.

24,438. Pearson, L. F. Nov. 25.

Heating buildings.—Supports for radiators for heating buildings consist of two brackets adjustably connected together. One bracket is attached to a wall, and the other supports the radiator. As shown in Figs. 1 and 3, a bracket *b* is hung from a staple *a* fixed in the wall. A second bracket *c* supporting the radiator is provided with a T-shaped lug *c'* which can be passed in and out

through a slot *b'* in the bracket *b* by giving a quarter turn to the bracket *c*. A tooth *c''* on the bracket *c* engages one of the teeth *b''* in the face of the bracket *b*. If the bracket *b* is to be attached to

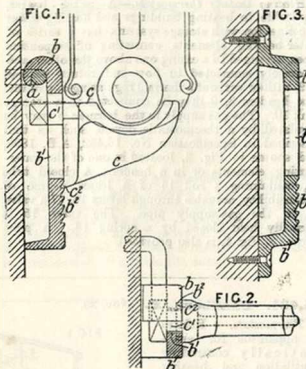

a wooden partition or the like, the staple *a* may be dispensed with, and the bracket attached as shown in Fig. 3. In some cases, the teeth *b''*, *c''* are not employed, the T-shaped lug being replaced by a bolt or stud passing through the slot *b'* and carrying a nut on the inside, by which the bracket *c* is secured in any position.

24,460. Quiggin, D. A. Nov. 27.

Heating water.—Relates to condensers for the exhaust from the auxiliary engines on board ship, being particularly applicable to turbine steamers, the heated condensing-water of which may be employed to supply baths or the like. The condenser is fitted with two stacks of tubes 9, through the upper of which the main feed is circulated, the lower being supplied with a regulable amount of sea-water to complete the condensation and cool the water of condensation sufficiently to allow of efficient filtration before it is mixed with the main feed. A perforated

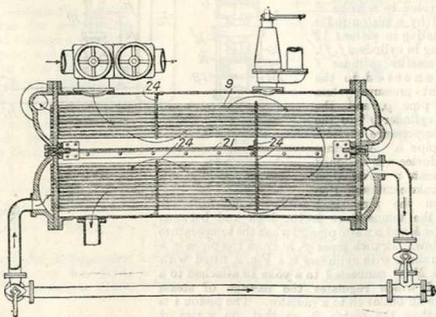

division plate 21 may be fitted between the compartments and baffle-plates 24 to prolong the path of the steam. Coiled tubes may replace the straight tubes shown, and the steam may be passed through instead of around the tubes.

24,717. **Fondu, L.** Nov. 29.

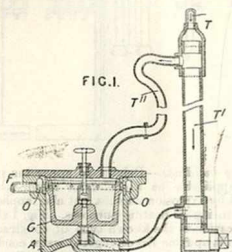

Steam traps.—The drain pipe T communicates by the branches T', T'' with the bottom and top, respectively, of a casing A, within which moves a suitably guided piston C. A number of holes in the casing, which are uncovered when the piston falls or is depressed by the handle shown, allow the water in the branch T'' to escape into an annular passage O in communication with the discharge pipe F. The branch T' normally remains full of water, and maintains a constant pressure beneath the piston, which is depressed by a sufficient accumulation of water in the branch T'' acting on its upper surface, the dish-shaped shape of which allows sediment to collect. The piston may be replaced by a weighted diaphragm, constructed of flexible metal rings hinged together, the motion of which is adapted to actuate a valve in the trap cover.

24,737. **Faller, O.** Nov. 29.

Heating liquids.—In apparatus for boiling impure liquids, or such as deposit mud or other solid substance on boiling, such apparatus being particularly applicable to the treatment of cellulose preparations, the heating is effected in a part A, which consists of inclined tubes surrounded by a casing through which the heating medium passes. The casing is prolonged to project into an upper receptacle B, to prevent the choking of the tubes by reason of the sudden cooling of the liquid on emergence. The solid particles are carried off by the circulation of the liquid, and pass through a downcomer C which connects the upper chamber B with a lower vessel D, which serves as a settling-chamber. A connexion E makes communication

between the lower chamber D and the heater A. A modification having two heating-chambers A, one on each side of the downcomer C, is also described.

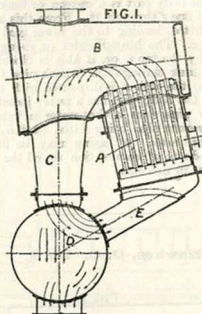

Specifications No. 463, A.D. 1872, No. 9499, A.D. 1892, [*Abridgment Class Distilling &c.*], No. 8763, A.D. 1900, and No. 20,147, A.D. 1902, are referred to.

25,002. **Burnett, J. R.** Dec. 2.

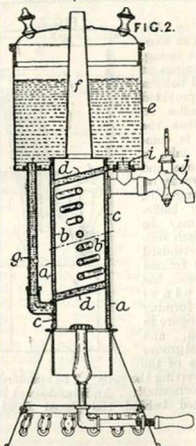

Heating water &c.—A water-heater consists of a body part made of inner and outer cylinders b, a,

the annular space *c* between them being closed at each end. Opening into this thin water space are inclined and spirally arranged cross-tubes *d*. Supported on the body part is a cistern or tank *e* having a conical flue *f* through it. From this a down-comer *g* is fitted, leading to the lower part of the water space *c*. The heated water on rising can be drawn off by the tap *j*, or, if this is closed, flows back to the tank through the branch pipe *i*. In a modification, the tank *e* is dispensed with and the top end of the body part has a water-jacket, from which a flow pipe runs to hot-water radiators and the like, a return pipe being fitted at the bottom of the water-heater. A casing may be fitted to pass the products of combustion round the outside of the heater in this case.

25,032. Hawkes, O. C. Dec. 2.

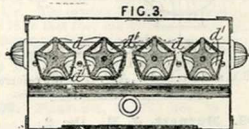

Heating by electricity.—In an electric stove, a casing, having openings at the top and bottom only, is provided with baffles so arranged that the heated air is compelled to take a waved course and impinge directly on the heating-coils. The upper baffle-plate *e* may be hinged. Each coil-carrying standard *d*, which is formed in one piece, has longitudinal grooves *d*, forming a star-like figure in cross-section, and also a helical groove in the edge of the ribs for receiving the coils. The standards may be arranged horizontally. An incandescent lamp *i* may be arranged behind the glazed front of the casing.

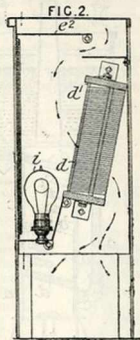

25,242. Livingston, D. M. Dec. 5.

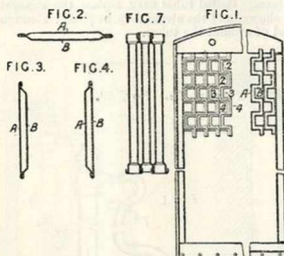

Heating buildings.—Relates to apparatus particularly applicable as a cooler for motor-vehicles propelled by explosion engines, but also applicable for condensing or heating purposes. Fig. 1 shows the application to the known type of construction that is built up from flat corrugated water conduits, Figs. 2, 3, and 4 being cross-section on the lines 2-2, 3-3, 4-4, respectively. The water passages are formed from corrugated plates A, B, each having one plane and one hooked margin, so that the plates interlock on being slid together in the direction of the length of the corrugations. In shaping the plates, the hooks are formed first, spacing-strips of the same thickness as the plates being placed within them during corrugation. In a modification, tubes corrugated zigzag fashion are employed. In applying the invention to honey-comb radiators, hooks *c*, Fig. 7, are formed on one end of each tube, the other end being left plain to engage hooks on the adjacent tubes. The joints in each case are completed by soldering.

25,270. Glendinning, W. M. Dec. 5.

Heating water.—A device for regulating the supply of gas to the burners of a geyser or other water-heater by means of the flow of water comprises an outer cylinder *a*, with a water inlet *c* and an outlet *d*, and an inner hollow cylinder *e*, which is provided with a notched cap *f* guided by a rib *g* on the interior of the cylinder *a*. The lower end of the inner cylinder passes through a stuffing-box *h* into a gas chamber *l*, and seats upon the gas inlet *m*. Inlet and outlet openings *h*, *i* are provided in the inner cylinder, so that when water is admitted at the inlet *c* it enters and lifts the cylinder and admits gas to the burners by means of a pipe *o*. When the water supply is cut off, the inner cylinder sinks and so closes the gas-supply inlet *m*. A pilot-burner may be provided.

(For Figure see next page.)

25,270.

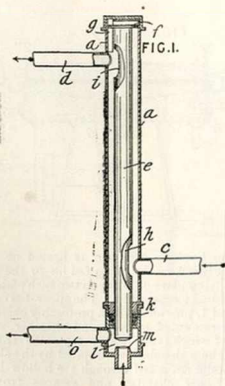

the lower portion of the burner tube, which is open but is provided with a fender plate *g*, supported

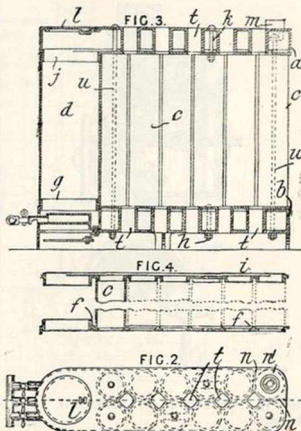

25,321. Atherton, G. Dec. 6.

Heating buildings.

—In a radiator for warming rooms, the products of combustion from a gas burner in a burner tube *d* circulate through upper and lower heat boxes *a*, *b* and radiating-tubes *c*, to an outlet *m*. The heat boxes are provided with covers *f*, *i*, respectively, as shown in Fig. 4. The lower cover *f* is provided with circular apertures having marginal seats for the tubes *c*. The upper cover *i* has corresponding apertures provided with flanges which enter the tubes *c*. The covers are secured to the heat boxes by bolts *h*, *k*. The burner tube *d* is held by flanges *g*, *j* on the covers of the lower and upper heating-boxes respectively. The burner tube is provided with an aperture which may be closed by a lid *l* or a cooking-vessel. The products of combustion leave the apparatus through an exhaust chamber *n*, Fig. 2, which is formed by upright walls *n*, arranged at right-angles to each other in one corner of the upper heat box. The chamber communicates with one radiator tube only, so that the gaseous products in this tube pass in a direction opposite to that in which the gases pass in the other radiator tubes. Vertical air passages *t* are arranged between the tubes *c*. The whole structure is held together by bolts *u*. Fig. 6 shows

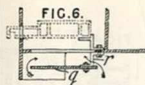

by a bracket *r*, in order to prevent the escape of heat in a downward direction.

25,386. Still, W. M., and Adamson, A. G. Jan. 30, [date applied for under Patents Act, 1901].

Heating buildings; thermostats.—The admission of steam to the radiators is controlled by a thermostatic device, which closes the steam inlet when the pressure in the radiators reaches a predetermined limit, the thermostat being brought into action by the special valve described below. The valve *g*, opened preferably by the steam pressure, admits steam to a chamber *e*, from which it passes by passages *h* to the radiators until the required pressure is reached. A by-pass valve *q* then lifts, allowing steam to pass by a passage *i* to a chamber *n* containing a thermostatic capsule *k*, the resulting expansion of which is adapted to close the valve *g*. The valve-piece *q* is formed with a lower narrow portion *q'* and an upper wider portion *q''*, which rests on a seat *q''*. The valve is lifted by the steam pressure on the narrow end, and is thrown wide open when the steam acts on the larger area of the wider part *q''* after passing the seat *q''*. This uncovers a port *q''*

and admits steam to the passage *i*. Passages through the head *q*² equalize the pressure above and

25,394. **Tyson, F.** Dec. 6.

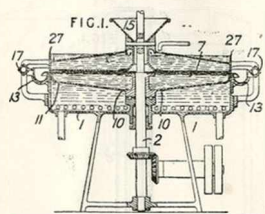
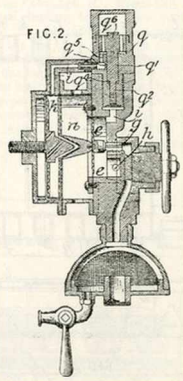

Heating liquids.—Milk &c. is heated or cooled for pasteurizing &c. by being fed on to the centre of a revolving plate or between two such plates kept at the desired temperature. The apparatus consists of a vessel 1, provided with a preferably chambered top 7, surmounted by a second chamber 27, the bottom of which is adjustably separated from the top 7. These chambers are rotated by the shaft 2, and the milk &c. is fed through the hollow hub 15 of the upper chamber and escapes from the periphery of the disks into a trough 13. The chambers are filled with water kept at the desired temperature, circulation being promoted through perforations 10, 11 by the centrifugal force.

below it. Specification No. 9209, A.D. 1904, is referred to.

25,443. **Quiggin, D. A.** Dec. 7.

Heating water.—Apparatus intended chiefly for heating feed-water by exhaust steam, but applicable also as a condenser, evaporator, or the like, is composed of spiral tubes 12 arranged in multiple-threaded coils, all of the same diameter and pitch. The spirals in each coil are brazed at the ends to junction pieces 13, Fig. 2, which are connected as described in Specification No. 5992, A.D. 1890, [Abridgment Class Pipes &c.], to end water chambers. These may be fitted separately, as shown at 10, or they may be formed in the ends of the casing 1. Where only a few coils are used, the water chambers may consist of simply branch pieces 20, Fig. 4. When live steam is employed as the heating-

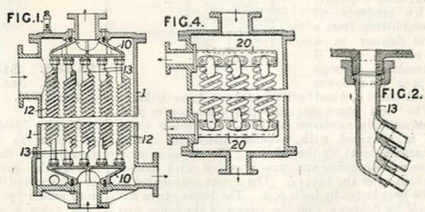

medium, it is preferably passed through the coils, the water being on the outside. The tubes instead of being circular in section may be crescent-shaped, as described in Specification No. 15,229, A.D. 1888.

25,449. **Motion, R.** Dec. 7.

Heating water.—A combined hot water boiler and steam generator automatically maintains a supply of hot water, of which any proportion is converted into steam. The apparatus, which is stated by way of

1905]

ABRIDGMENT CLASS HEATING.

example to be for use in connexion with laundries, dyeworks, swimming baths, and chemical works, is contained in a single casing and is heated by a furnace burning producer or other gas. The supplies of gas and air to the furnace at the water-heating end of the apparatus are regulated according to the level of the water in the heater, and at the generator end according to the pressure of the steam in the generator. The supply of water is also regulated by the level of the water in the heater. The quantity of water passing from the heater to the generator is controlled by the water level in the generator. Water heated by the tubular heater A^3 or by other means is fed by the pipes B^3 , B^2 to the tubes B^1 , which extend the whole length of the apparatus and terminate in the tank B^3 . The water passes from the tank upwards to the drum B , which is formed in one with, but divided from, the steam receiver C . A rod N^{10} connected as shown to a rack and pinion actuated by a float D in the boiler controls the action of the tumbler lever N^5 , which, by the engagement of its pins N^7 , N^8 with another lever determines the position of the feed-valve D . A pointer D^5 indicates the water level in the boiler.

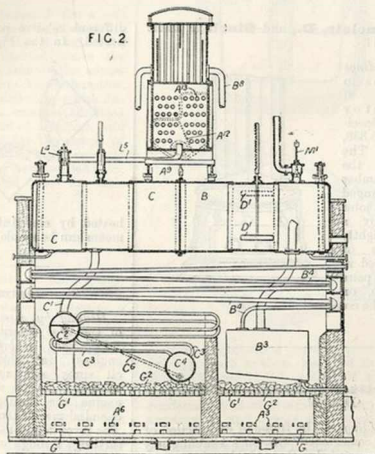
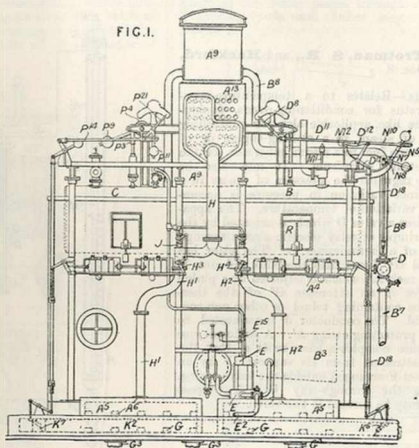

25,576. Trotman, S. R., and Hackford, J. E. Dec. 8.

Thermostats.—Relates to a temperature-regulating apparatus for conditioning-ovens, dyeing-vats, and the like, applicable also for controlling the supply of steam to a stoking-engine or of liquid or gaseous fuel to a steam generator, or the supply of steam therefrom. It may also be employed to regulate the pressure of steam in a generator, since variation in pressure is accompanied by a variation of temperature. The apparatus comprises a valve D which is actuated by the closure of a simple or relay electric circuit through the medium of a thermometer A. The latter has one terminal G¹, fused into the bulb and one K secured to a rack K¹, which is adjusted by a pinion L and moves in an extension G³ of the thermometer tube containing toluol or other non-conducting liquid. The conductor J¹ is connected to the metallic protecting casing A¹. A sufficient rise of temperature completes the circuit so that the valve D is attracted from its support D¹ by an electro-magnet F arranged outside the valve casing, thus closing the through-way C. A by-pass opening D² may be formed in the valve.

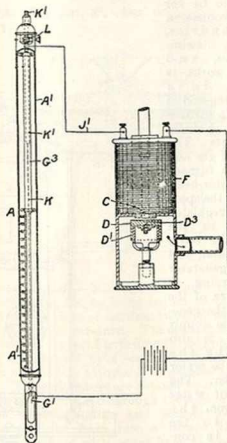

25,773. Sinclair, D., and Sinclair Iron Co. Dec. 11.

Heating buildings etc.—Relates to modifications in the radiator described in Specification No. 25,339, A.D. 1902. The bottom of the circulation chamber a with its flanged longitudinal joint is replaced by a thin flat or slightly curved plate of metal c secured in position by pairs of flanges b, on each side of the combustion chamber.

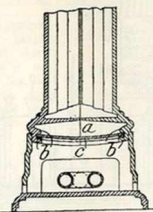

25,855. Betts, L., and Improved Electric Supplies. Dec. 12.

Heating buildings.—The frame of each section of a radiator is constructed with lugs enabling any section to be connected with a neighbouring one by a hinge joint, so that various elements can occupy

different relative positions without being disconnected. In the Figure, the radiator is shown

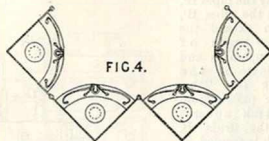

heated by electricity, but oil or other heating means can be employed.

25,979. Westmacott, A. Dec. 13.

Heating by chemical action.—In carburettors of the type described in Specification No. 3613, A.D. 1905, [Abridgment Class Air and gas engines], in which the mixture of heavy oil spray and air passes through a tubular vaporizer on the way to an internal-combustion engine, the heating at starting is effected by chemical means, thus avoiding the use of a flame. The invention consists in employing a lime or like cartridge through or around which the spray and air passes and into which water or other liquid is introduced; several forms of the invention are

described. Fig. 3 shows a carburettor with a mixing-chamber *c* and a vaporizer *b*, and between them a chamber *a*¹, for receiving a lime cartridge *d*, divided into two chambers *d*¹, *d*², the upper of

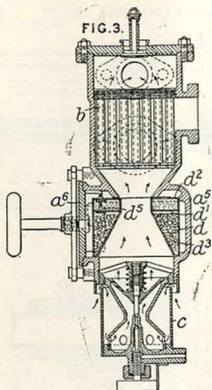

which contains water and a piercer *d*³ for a soft part of the partition *d*¹. The chamber is closed by a door *a*¹, to which the cartridge is attached. The cartridge chamber may be situated above the vaporizer, in the cylinder cover around the admission valve, or on a by-pass from the carburettor. The water may enter a perforated ring which distributes it uniformly, and it may be admitted thereto by a needle valve instead of a piercer, and a safety-valve may be provided for the escape of steam. The water chamber may be made separate from the lime chamber, or it may be dispensed with, and the water may be poured into the lime chamber.

26,080. Shiels, A. Dec. 14.

Thermostats.—The temperature of the cooling-water for engines used on motor road vehicles and for other purposes is kept constant by inserting a by-pass controlled by a thermostat in the circulating system. As shown in the Figure, the cooling-water leaves the cylinder by the pipes *E*¹, *E* and passes to the regulator *A*¹ through the independent pipe *G* and the cooler *C*, to be returned to the cylinders through the pipe *H*. As the temperature increases, the supply of water entering the regulator through the pipe *G* is gradually cut off by the expansion of a flexible capsule or chamber *A*, containing a volatile liquid, which controls the sliding valve *B*. Should the ports *b* completely close, the

whole of the water passes through the cooler *C*. Expanding rods and tubes may replace the capsule *A*.

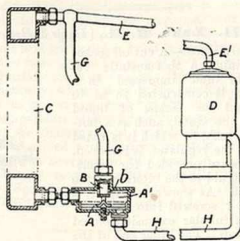

26,116. Poole, W. J. Dec. 15.

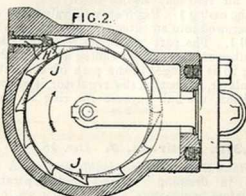
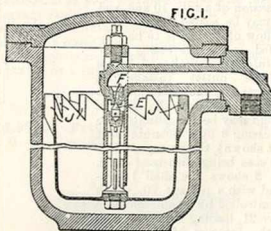

Steam traps.—In a steam trap of the inverted-bell type, such as those described in Specifications Nos. 5938 and 11,801, A.D. 1901, and No. 17,281, A.D. 1902, the inlet *H* for steam and water of condensation is of lesser area than the discharge aperture *F*, and directs a jet upon vanes *J* connected to the open bell carrying the discharge valve *E* in such a manner as to cause the rotation of the bell and consequent grinding of the discharge valve

upon its seat. The inlet H is preferably arranged tangentially to the bell. When the bell falls, opening the valve E, the steam enters through the

nozzle H and causes the bell to rotate. The inertia of the bell is sufficient to cause a gridding of the valve when the bell again rises.

26,271. Lake, H. H., [Davis & Roesch Temperature Controlling Co.]. Dec. 16.

Thermostats.—A cut-off socket containing a thermostatic regulator and immersed in a liquid is constructed so as to prevent the escape of liquid from the vessel, such as a hot-water tank, to which it is fitted when the regulator is removed. Means are provided for admitting liquid to the interior of the socket. As shown in Fig. 1, a shell 1 screwed into the tank has a tubular extension closed by a cap. The other end of the shell receives the regulator, which is of the expansion type. Within a casing 8 is located a valve seat 9 on which a valve 12, operated by the differential expansion of a tube 10 and rod 11, may be seated. The fluid, the flow of which is to be controlled, enters the casing 8 by the inlet passage 13 and leaves by the outlet passage 14. Passages 17 enable this liquid to circulate through the socket. Liquid may be also admitted to the casing 8 by a separate inlet (not shown), the passages 17 in this case being dispensed with. Fig. 3 shows the shell 1 provided with a passage 20, which is controlled by a hand-operated valve 21, leading from the tank to the interior of the socket. An air vent may also be fitted in the casing 1. Fig. 5 shows a valve-seat member 27 screwed into an extension of the recess 6 in the shell 1. The part 27 carries a valve 24 having a number of stems 25 extending to a ring 26. The ring 26 is arranged in the path of the hub of the regulator, so that, as the regulator is screwed into position, the hub engages the ring 26 and forces

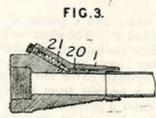
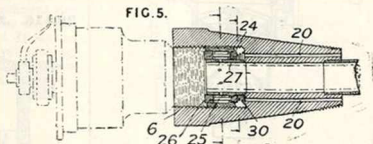
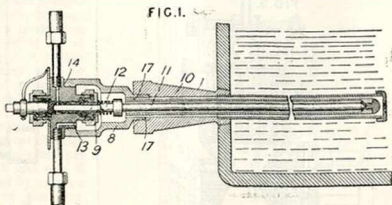

the valve 24 inwards to open against fluid pressure and the pressure of a spring 30. Liquid flowing from the tank through a passage 20 then enters the socket. In a modification, two or more valve seats carrying valves are screwed into recesses in the extension 6 so as to close the passages 20 when the regulator is withdrawn.

26,372. Jeffreys, J. Dec. 18.

Steam traps; heating buildings &c.—A trap for use in draining steam-heated apparatus, e.g. radiators, condensers, and vacuum pans, comprises a T-shaped fitting having inlet and outlet connexions a, b and a collecting-chamber c into which depends an open-ended slotted or perforated tube d surrounded by a strainer k. A screw-down valve h controls the escape aperture f, and porous material may be placed in the chamber c to prevent hammering or pulsations. By means of this device, small quantities of steam, air, and water are allowed to escape incessantly, but the full discharge of water takes place only upon abnormal accumulation.

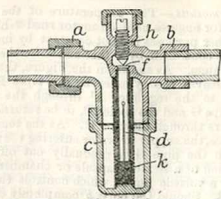

26,524. Wheeler, H. J. Dec. 19.

Heating water.—Relates to a geyser of the open type. Within an outer casing, a central cone B, closed at its upper end is supported above a circular rim C, which is supported above a second cone D. The cone B is surmounted by a water-distributing dome E, which is perforated at its outer edge to permit water to flow into an annular cup G. The water, which enters the apparatus by a pipe located in the flue J and passes over the dome E, flows partly into the cup G and down the outside of the cone B, and partly down the outside of an outer wall B' which is joined to the rim C. The water collects in the space between the outer shell and the cone D and is drawn off through the outlet H. The products of combustion from a burner located in the hood D fill the cone B and then pass under the lower edge of the cone to the space between the wall B' and the cone, whence they escape by outlets I to the upper part of the external casing.

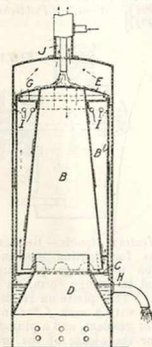
26,527. Westrope, G. W., and Cooper, E. E. Dec. 20.

Heating liquids.—Water or other liquid is heated for softening, sterilizing, or other purposes in a vessel A which is supplied from a cistern E and provided with baffle-plates to regulate circulation and promote settling of impurities. To ensure that only water that has reached a certain temperature shall leave the vessel A, arrangements are made that it shall overflow at a level higher than that which is maintained, e.g. by a ball cock, in the cistern E. The water may be heated by blowing in steam, by a steam coil, or by a gas or lamp flame. The top of the vessel A may be open or

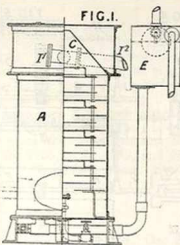

provided with a perforated expansion piece and may be surrounded by a gutter to which discharge pipes I, I' are connected. Or the top may be narrowed to a cone C as shown in Fig. 1. In a modification, the discharge pipe is connected directly to the top of the cone. A vent to the atmosphere is provided to allow of the escape of carbonic acid gas or other volatile impurities. The period of heating and the rate of flow are regulated by adjusting the heat supply; this may be done automatically, when steam is the heating-medium, by a float in a storage tank for the treated liquid. The temperature attained may be regulated by adjusting the constant level in the cistern E, which may be provided with a safety overflow below the level of the overflow in the vessel A. A heat interchanger may be combined with the apparatus. Specifications: No. 7138, A.D. 1890, and No. 17,372, A.D. 1894, are referred to.

26,577. Frith, W. F. L., and Grist, C. J. Dec. 20.

Digesters. Apparatus adapted for treating metals such as steel and steel alloys with mercury, mercury vapour, or other medium at a high temperature consists of an hermetically-sealed vessel enclosed in an outer vessel which contains a heat-conducting substance of low melting-point and which is heated by a furnace or otherwise.

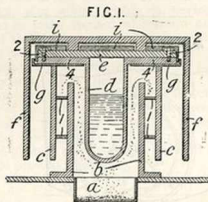
26,578. Frith, W. F. L., and Grist, C. J. Dec. 20.

Digesters; non-conducting coverings.—It is a highly heated "muffle" or furnace for heating metals such as steel or steel alloys in mercury vapour contained within hermetically-sealed receptacles, and for like purposes, the latter are provided with means for protecting the joints, fastenings, and other parts of their covers so as to render them gas or vapour tight. As shown in Fig. 1, the receptacle d is arranged above a furnace a contained within inner walls b and outer walls c, the latter being supported on stays 1 and also serving to support the receptacle by its flange 4. The lid e is packed and bolted down by bolts 2. A cap or hood f, or, lined with, non-conducting material surrounds the whole apparatus and is supported by

the lid *e*. The bolts 2 and the underside of the flange 4 are also protected by non-conducting material *i*, *g*. In the modification shown in Fig. 2,

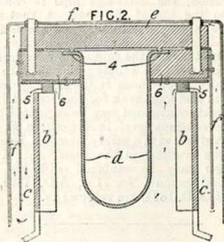

the receptacle *d* is supported by the inner wall *b* through the intervention of supports 5 and extensions 6 of the flanges 4. The outer wall *e* is in this case of much lighter construction.

26,788. Potter, H. N. Dec. 30, 1904, [date applied for under Patents Act, 1901].

Non-conducting compositions.—Consists in the use of silicon monoxide, which is a very fine powder and is a good non-conductor of heat, as its particles enclose a considerable quantity of air.

26,820. Deutsche Fulgor Werke Ges.

Nov. 25, [date applied for under Patents Act, 1901]. *Void.* [Published under Patents Act, 1901.]

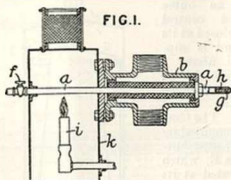

Heating liquids.—Relates to a safety apparatus for heating gasolene by means of the action of spongy platinum, or other precious metal in spongy form, on a mixture of air and gas. The platinum is placed in a pipe *a*, provided with a cock *f* for introducing the air and gas or gasolene, and a plug with a narrow opening *h* for the escape of the products of combustion. The gasolene, in the form of vapour mixed with air, passes through a casing *b* surrounding the pipe *a*, which is enclosed by an outer pipe with a wire-gauze covering, or by the gauze alone. To start the action, the gas in the pipe *a* is heated for a few seconds by a Bunsen burner or other heater *i* enclosed in a casing *k* constructed after the fashion of a Davy lamp. In a modification, a vessel containing liquid gasolene is substituted for the casing *b*.

26,859. Salvanesi, P. Dec. 23.

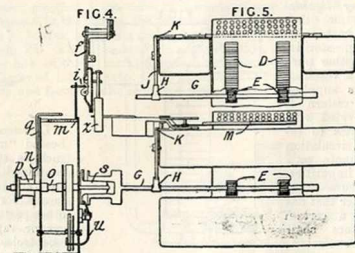
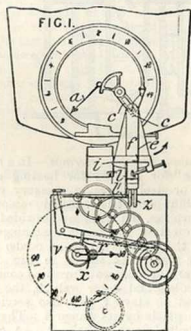

Thermostat.—In apparatus for vulcanizing dental and other rubber articles, of which Fig 1 shows a front

view, Fig. 4 a side view with the boiler omitted, Fig. 7 a plan, and Fig. 5 a sectional view of the wick burner, the temperature is regulated automatically by means of a fork *s* carried by an arm *f* connected

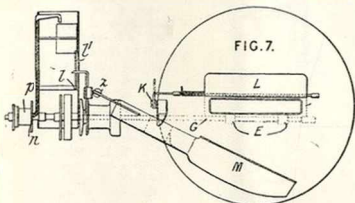

to the pressure-gauge pointer *a* and adapted to move the weighted blade *M* to or from the flame of the wick burner used to heat the boiler of the vulcanizer.

26,972. Brunler, O. H. U. Dec. 27.

Heating liquids and gases.—A flame burns beneath the surface of water or other liquid, from which hot liquid and gases can be obtained for heating purposes. Liquid combustibles and compressed air or oxygen are led through pipes *d*, *c* respectively, and burn in a flame *b* below the surface of the liquid. The flame may be started by heating the pipes *c*, *d* with a soldering-lamp. As soon as the flame *b* is formed, the liquid combustible is stated to be gasified in the under part of the pipe *d*. The combustion gases escape by a pipe *e* and the heated liquid through an overflow pipe *g*. The liquid is introduced by a pipe *f* in such quantity only that the outflow is heated. The pipe *g* is connected with heating pipes &c. Specifications No. 11,494, A.D. 1894, No. 9855, A.D. 1898, and No. 18,563, A.D. 1903, [Abridgment Class Steam generators], are referred to.

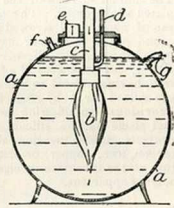

27,082. Angelis [née Vecchi], G. de. Dec. 28.

Non-conducting compositions.—A non-conducting and refractory material is composed of a mixture of magnesium carbonate, magnesium oxide, and cellulose, to which a mixture of raw alum, boric acid, water and gelatin, and starch or casein is added, and, if desired, wood, cork dust, and soot.

27,098. Haddan, R., [Richardson, E. H.] Dec. 28.

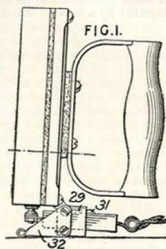
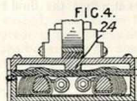

Heating by electricity.—In electric hand-irons, means for the special heating of the toe and rear corners and a simple switch, the case of which acts also as a stand, are provided. Two cores with narrow tongues at the ends fit tightly into recesses at the toe and heel corners; they are rounded but with flat bases and are surrounded by coils insulated by sheets of mica. The toe ends of the wires are intertwined, and the rear ends are held by binding-screws passing through the rear of the iron and insulated therefrom by mica. A mica sheet also insulates the coils from the bottom of the iron. A sheet of heat-insulating material such as asbestos rests above the cores and is cut flush with the sides of the iron body and pressed slightly down by a boss 24 on the cover, which is screwed down above the sheet of asbestos. The bail of the handle is screwed down on this boss, a layer of asbestos intervening. A hollow lug 29 is preferably cast in one with the cover, at the rear, and a switch plug slides within it, having terminals adapted to make contact with strips on the outer ends of the binding-posts when inserted as far as a stop 31 will allow. The plug fits tightly enough to allow contact to be broken by pulling the plug only slightly out. It is provided with a T-piece the barrel-shaped top of which prevents such sharp curvature of the wires as would break them. A hood or stand 32 is secured to the lug 29 so as to protect the binding-posts and the plug. It may be formed of sheet metal with its free end formed into a roll to prevent scratching.

27,267. Croizat, V. Dec. 30.

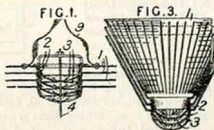

Heating liquids and gases.—Apparatus for heating or cooling fluids is built up from elements consisting of plates 1 in which are pressed recesses

having perforated bottoms 3, the sides 2 of such recesses being of conical form to fit into each other. A series of such elements are assembled and secured together by a bolt 4. Covers 9 admit the fluid to

the tube so formed. Fig. 3 shows an alternative construction in which the outer portions 1 of the plates are arranged at an angle to the axis, and fluted or corrugated.

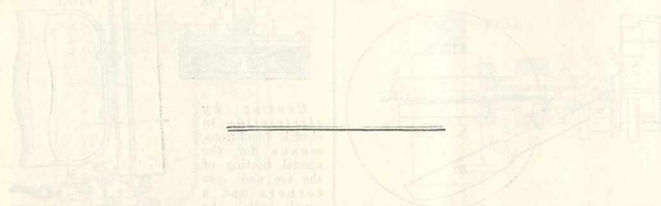

A.D. 1906.

18. Hatfield, H. S. Jan. 1.

Heating by electricity.—Electric resistances applicable in heating-apparatus are made of massive metallic silicon either pure or alloyed, and provided with contact-pieces made of nickel-steel or other metal or alloy having a small temperature-expansion coefficient, in order that connexion may be maintained when the contact-pieces are hot.

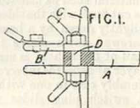

The contact surfaces of the silicon may be electroplated with copper. The contact-piece may be a cap of nickel-steel screwed on the plated end of a round bar of silicon, or may be a nickel-steel bolt passed through the silicon. In the form shown in Fig. 1, contact-pieces B of copper, brass, or cast iron, having webs C to radiate heat, are secured on the silicon bar A by bolts D of nickel-steel. The Provisional Specification mentions casting the contact-pieces on the silicon, and the use of spring contacts; it also mentions alloying the silicon with carbon, iron, copper, or platinum, and the application of the invention in cigar lighters and electric heating-apparatus.

87. Cooke, E. W., and Kelly, J. F. Jan. 1.

Heating air for drying. The invention is described in connexion with the drying apparatus described in Specification No. 14,855, A.D. 1905, [Abridgment Class Drying &c.], and consists in the use of mixing-boxes for regulating the supplies of hot, cold, and dry air. Fig. 1 shows in plan the chambers 10, air casing 8, air drier 40, heater 50, refrigerator 60, fans 70, 80, and furnace 90. These various parts are connected by valve-controlled tubes, and valved air inlets 41, 49, 52, 53, 61 are provided. The air may pass through the refrigerator 60, drier 40, heater 50, fan 80, and hot-air duct; or this hot-air duct may be

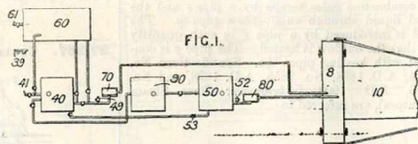

used with air passing through the fan and (1) the heater alone, (2) the drier alone, (3) heater and drier, or (4) refrigerator and drier. The cold-air duct may be used with the fan 70 (1) alone, (2) with the refrigerator, or (3) with the drier and refrigerator.

425. **Thompson, W. P.**, [Johnson, W. S.].
 Jan. 6.

Thermostats. — The supply of feed-water to a generator is regulated according to the temperature of the issuing superheated steam by means of a thermostat consisting of a perforated tube C', which expands upon contact with the steam and actuates a valve H' in a bypass to the feed-pump N'.

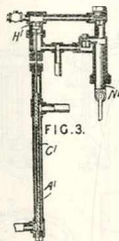

558. **Rampal, L. F.** Jan. 9.

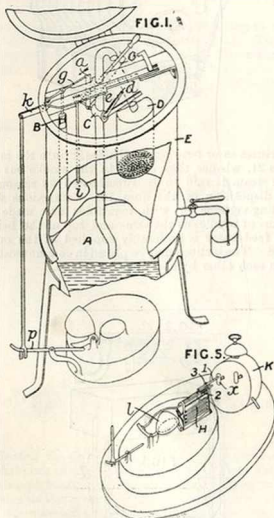

Heating liquids. — Automatic apparatus for making tea &c., or for sterilizing, washing, and like purposes, comprises means for igniting a lamp &c. at a predetermined time beneath a boiler with a safety-valve capable of actuating a cock when a

predetermined pressure has been reached, thereby permitting the heated water or other liquid to flow into or round a second receptacle containing the tea or other substance to be infused, sterilized, or washed, and means for closing the cock when a predetermined quantity of water has flowed from the boiler, and for simultaneously extinguishing the source of heat or removing the boiler therefrom. The lighting may be effected by the key *x* of an alarm clock which by releasing the arm 1 from the catch 3 permits the spring 2 to turn back the extinguisher *l* and operate a suitable lighting-device H. When the temperature of the water in the boiler A, Fig. 1, has been sufficiently raised, the valve B operates the lever *g* to set free the arm *a*, and so permits the cock C to turn under the influence of a spring *e* or gravity &c. until the arm *d* engages the notch *e* of the lever K. When a certain quantity of water has thus flowed from the boiler into the infuser &c. D and vessel E, the float *i* raises the lever *k*, permitting the arm *d* to turn farther into a closed position, the lever *p* at the same time extinguishing the lamp. In other forms, the receiver E and the boiler are attached to either arm of a pivoted lever, or the receiver is suspended from a spring, the movement of one or the other when the water flows operating the extinguishing and valve-closing devices. In a further form, the receiver is suspended by chains which are also attached to the boiler beneath, the transfer of the water causing the receiver to fall and the boiler to rise from the stove &c. In some instances, there is no provision for closing the cock, and sometimes the construction is such that the boiler can only be filled or the lamp lit when the other parts are in the correct position. Several receivers may be connected to one boiler, in which case the boiler cock may be permanently connected to the pressure valve, while a second cock to be opened by hand but closed automatically is placed near each receiver. Instead of a spirit stove as shown, any other form of heater may be used, such as a gas burner, the cock of which would be adapted to be operated by the extinguishing-mechanism.

611. **Domville, F. D.** Jan. 9.

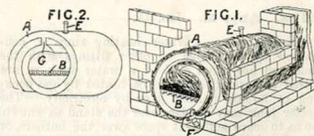

Heating water, boilers for. The boiler consists of a water chamber A with a transverse-section in the form of a spiral, so set in brickwork that the course of the gases from the internal fire-box B is heated on both sides. The water inlet is at F and the outlet at E. Fig. 2 is a view from the rear, showing the passage G between the two convolutions.

1018. Frost, J. E. Jan. 14, 1905, [date applied for under Patents Act, 1901].

Heating water.—A vertical sectional boiler for producing steam or hot water, e.g. for supplying heating-systems, is shown in perspective in Fig. 1 and in sectional plan in Fig. 5. Each section 1, Fig. 2, mounted on water legs 11, consists of outer water spaces 14 which extend upwards into the steam or water space 16 traversed by flues 19, and are separated from the inner spaces 12 by side flues 20, 21. The inner spaces are connected with each other by the wedge-shaped water space 13, and with the spaces 14 by solid or hollow connexions 15. The side flues 20, 21 are separated by means of baffle-plates 38 formed integral with the sections or consisting of plates supported on lugs 22, and are broken away at various points to provide passages from the upper to the lower flues. A convenient form of baffle-plate is shown in Fig. 10, the opening 51 therein being adjustable by means of superposed damper plates, one of which is shown in Fig. 11, which dovetail together, being moved longitudinally as required. The sections are provided with ribs 23, 24, 25 on one half of each face, the opposing half of the adjacent section being plain. An asbestos rope or other packing is inserted between ribs 23, 25 on the inner parts 12, and when the sections are assembled the interstices are filled with plastic asbestos or other material and the whole drawn together by bolts 5, 7. The combustion gases pass upwards between the spaces 13 into the uppermost flues 19 and thence to the side flues 20, being prevented from escaping directly to the smoke-box by dampers suspended from a rod rotated and held by a weight on a cross-bar. The gases then pass from the flues 20, the rear ends being closed by baffles 36, through the

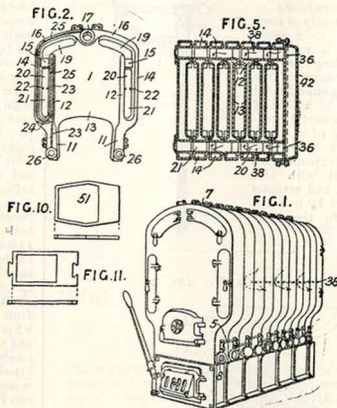

apertures in or between the baffles 38 into the lower flues 21, whence they escape to the smoke box 42. The steam is said to be superheated by reason of the disposition of the flues 19. Connexions with heating-systems or with manifolds are made by means of nipples at the sides and top of the boiler, and feed-water is preferably supplied at the opening 8. The sections may be placed in communication with each other by apertures 17, 26, 26.

1172. Aby, A. Jan. 16.

Heating water.—Water-heating rings *a*, connected by detachable or other fittings with the cold and hot pipes *c*, *d* of a water tank *w*, are fitted to a stand so as to be heated by gas cooking or boiling burners *g* or by electricity. The water tank may be placed over the stand as shown, so as to leave sufficient space over the burners, or may be placed in a separate room.

[Reference has been directed under Patents Act, 1902, to Specifications No. 4197, A.D. 1889, No. 16,826, A.D. 1900, Nos. 19,583 and 23,151, A.D. 1901, and No. 28,375, A.D. 1903, [Abridgment Class Stoves &c.].]

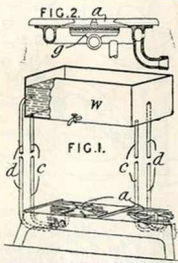

1245. **Kobusch, F. J.** Jan. 17.

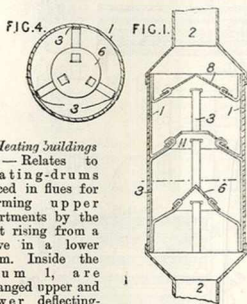

Heating buildings
etc.—Relates to heating-drums placed in flues for warming upper apartments by the heat rising from a stove in a lower room. Inside the drum 1, are arranged upper and lower deflecting-cones 8, 6, placed with apices upwards, the larger cone being at the top, and an intermediate conical ring 11. These are supported by uprights 3 bent in the manner shown.

1284. **Barnes, W. M.** Jan. 17.

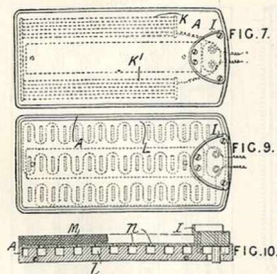

Heating by electricity; heat-storing apparatus.—In that class of ironing-machines employing a heated ironing-plate and a vertically movable ironing table, various methods are described of heating the table and its attached shirt clamp so as to prevent the accumulation of moisture and its consequent effect upon the previously ironed neckband. Figs. 7 and 9 illustrate two methods of heating the table by electricity; in the former construction, the current traverses the resistances K, K', and in the latter case the resistance wire is embedded in a layer L of porcelain forming the upper surface of the table.

In the method shown in Fig. 10, no separate heating-appliance is employed, but the heat from the ironing-plate passes through the layer M of asbestos and is retained by chambers *l* provided with apertures *n*.

1670. **Brooke, R. G.** Jan. 22.

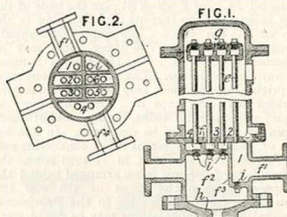

Heating liquids.—In apparatus for heating feed-water and other liquids, in which parallel straight tubes *e* are secured at one end to a fixed header *f* and at the other end to a movable header *g*, a special form of fixed header is employed. This header is formed as a casting the interior of which is divided to form connecting-passages 2, 3, 4 between the tubes. A water-inlet chamber 1 communicates directly with a water-inlet passage *f*¹. The remaining portion of the header forms with a cover-plate *h* a sediment-depositing chamber *f*², which is provided with a water-outlet passage *f*⁴. The water after passing through the tubes *e* successively in opposite directions enters the sediment chamber *f*², which is separated from the chamber 1 by a wall *f*³. The movable header may be divided into connecting-passages in the same manner as the fixed header. Openings, normally closed by screw plugs *i*, are formed in the connecting-passages and chamber 1 to afford access to the tubes.

1679. **Cope, J. T.** Jan. 23.

Heating liquids; heating buildings.—In apparatus for heating by the condensation of steam, or by currents of hot liquids, air, or other gases through or around metal pipes or tubes, the tubes are formed with deep longitudinal indentations or furrows *a* upon their upper parts, the lower parts *c* being plain to facilitate cleaning and the removal of deposit from the tubes. The tubes may be applied to calorifiers, water or other liquid heaters, vats or tanks for heating purposes, and radiators for warming buildings &c. Figs. 1 and 2 show the furrows inclined radially towards the lower part of the tube. Fig. 10 shows the furrows formed vertically. The corrugations may be formed by passing the tubes through graduated dies; or a

sheet of metal may be corrugated and the edges of sheet joined together as shown in Fig. 10. To connect the ends of adjacent tubes, cast-metal sockets D, Fig. 3, are formed with internal projecting pieces *d* which fit into the furrows. The outer ends of the sockets are cylindrical and may be provided with screw packing or flange attachments. Fig. 11 shows an arrangement of concentric tubes, one of which is indented longitudinally. The annular space between the tubes may be connected by caps F which fit over the ends of the outer tubes and have furrows corresponding to the furrows on the tubes. The caps communicate through branches G. The inner tubes may be connected by bends H. Fig. 15 shows a radiator for warming buildings. The tubes are connected to upright ducts L, which may be gilled and may be provided with end caps I. The tubes may be simple; or concentric tubes, the inner A' of which is open as shown, may be employed. In another form of radiator, horizontal tubes connecting side water spaces are arranged in vertical rows, the members of one row being arranged behind the air spaces between the tubes of the row immediately in front. According to the Provisional Specification, the indentations may be round, oval, square, or triangular, and may be longitudinal or twisted and encircle the tube spirally.

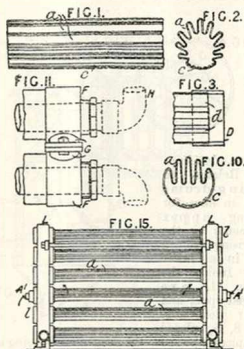

1769. Cramer, S. W. Jan. 23.

Thermostats.—To enable the temperature and humidity of the air in a factory or other building to be regulated automatically, the supply of hot-water or steam to the heating-system and the supply of water to the humidifying-system are controlled by electrically operated valves, the electric circuits being controlled by the wet and dry bulb thermometers or an hydrometer. The two thermometers 12, 2 have tubes bent as shown and provided with bulbs at each end. Threads of mercury 8, with non-conducting liquid, such as alcohol, on each side, control the circuits 23, 24 of the temperature and humidity regulating devices. The bores of the thermometer tubes are connected by

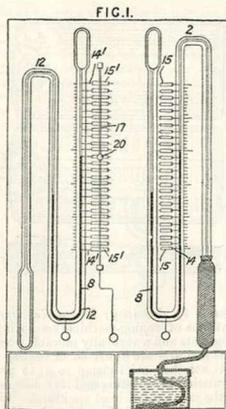
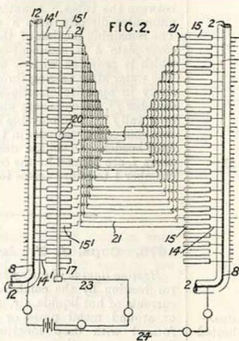

wires 14, 14' with metal bars 15, 15' connected together by wires 21, as shown in Fig. 2, in such a way that the difference of the two thermometer

readings at the ends of each wire corresponds to the humidity required. The electric circuits are completed through a sliding brush 20 adjusted along a metal bar 17 to the temperature it is desired to maintain.

1837. Virgili, F. Jan. 24. *Drawings to Specification.*

Heating-liquids and gases.—A furnace grate, which is stated to be applicable to steam boilers, lime kilns, bakers' ovens, and the like, is formed of bars with transverse holes surrounded by flanges or ribs to constitute, when the bars are placed in position, air passages or conduits, or to be capable of receiving a circulating pipe for gases or liquids to be heated or superheated.

1904. Stewart, A. W. Jan. 25.

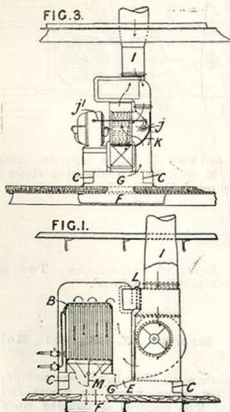

Heating air.—Relates to improvements in the type of apparatus for heating, cooling, and ventilating ships described in Specification No. 4783, A.D. 1898, and termed "thermotanks," and consists in fitting the air-trunks and valves within the body of the casing, which is fixed over a single aperture in the deck. The general arrangement of apparatus as described in the above-mentioned Specification is employed, a two-way valve K in

the form of a curved plate actuated by a rock-shaft *j* and lever *j'* serving instead of the two valves, previously employed. When the valve K is in the position shown, and the valve M, Fig. 1, open, air is enabled to pass from the shaft I to the heater or cooler B, and thence to the passage F. A by-pass valve E may be provided to allow the temperature of the air-current to be regulated. When the plate K is in the position shown in dotted lines, air is drawn from the inner bottom G and expelled through a valve L, Fig. 1, to the shaft I. A single opening is made in the deck, the air-trunk G being formed by an inner casing C.

2072. Coles, S. O. Cowper. Jan. 26.

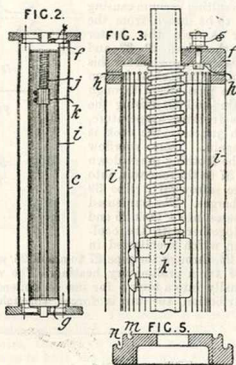

Heating by electricity.—In electric heaters in which heating-resistances *i* are arranged in tubes *c* so as to leave an annular space wherein air is heated, the resistances are formed of two concentric rows of laced wire. A central tube or rod carries two insulating-caps *f, g* between which the wire is laced. The wire may pass through holes *h* in the caps as shown in Fig. 3, or in recesses *m, n* as shown in Fig. 5. One cap *g* is fixed and the other cap *f* slides on the central rod. A spring *j* bears against this cap and against a socket *k* to keep the wire taut.

2345. Kelly, G. Jan. 30.

Non-conducting coverings &c.—In forming a self-sustaining non-conducting board, slab, or tile,

equal or other proportions of mineral wool and flax fibre are thoroughly mixed in water without pulping, the mixture being then run on to a

suitable draining-screen, lightly rolled, and dried. Specification No. 24,798, A.D. 1901, is referred to.

2451. Soc. Générale de Goudronnage des Routes. Feb. 22, 1905, [date applied for under Patents Act, 1901].

Heating liquids.—Figs. 1 and 2 show an apparatus for heating tar which is subsequently spread on road surfaces by a separate machine. The heater is filled with steam from the boiler 1 by the pipe 17 and reducing-valve 19, and this steam is condensed by pumping cold water on the heater by a pump 21 and pipe 22, the resulting vacuum causing cold tar to be drawn from the reservoir A into the heater through the pipes 29, 37 and cock 28, which is opened for this operation. The cock 31 is then opened to pass steam through the heating-coil 33, raising the tar to its frothing-temperature, at which juncture the cock is closed again. Any overflow during the frothing passes down the pipe 37 to the reservoir, into which the safety-valve pipe 39 also discharges. The condensed steam passes into a tank 25 and thence, together with the cooling-water, which is collected in a gutter 24, through the pipe 27 to a coil 26, which gives the tar a preliminary heating. The water passes finally into a tank 5 for use as boiler-feed. For distribution, the tar is forced through the

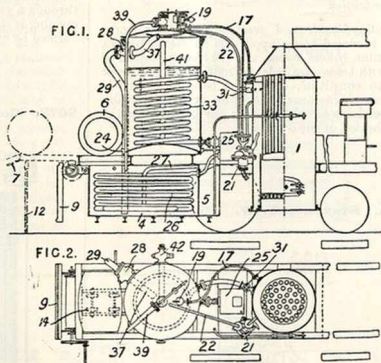

pipe 41 and cock 42 into a separate sprinkler by closing the cock 28 and admitting steam to the heater through the pipe 17.

2529. Brain, H. R. Feb. 1.

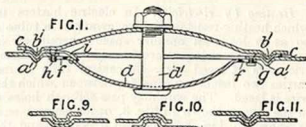

Heating water.—Relates to man-hole doors for boilers, tanks, and the like. The bridge-plate *d*, carrying the central holding-bolt *d'*, is provided at opposite points with slots *f*, which engage a pin *h* and a headed stud *g* respectively. A clip *i* engages the edge of the man-hole and holds the plate *d* in position. A tight joint is made by forming corrugations *a'*, *b'* round the edge of the man-hole and the cover and inserting packing *c*. Figs. 9 to 11 show

various forms of corrugations. Two holding-down bolts may be employed.

2778. Brooks, J. B., and Holt, J. Feb. 5.

Hot-water bags.—The bag in one modification is constructed in one piece, the mouth end being seamless. The material is doubled upon itself about this part and the edges secured by vulcanizing. Holes *e*, Fig. 1, for the passage of the water to the interior are provided, corresponding with holes in the plate *f*. The rubber of the bag and a stiffening piece *a'* are compressed between the plates *f*, *m* by means of screw pillars *g* to make a water-tight joint. A rubber-faced plate *h* sliding on these pillars is forced down, when required to close the bag, by means of a screw *i*. In another method of cutting the rubber, the two sides are connected together at the mouth by extended and

overlapping semicircular portions. In the modified form of valve fitting shown in Fig. 9, a solid cylindrical valve plate *h* is forced down by a screw *i* in the interior of a cylindrical body part *f*, which

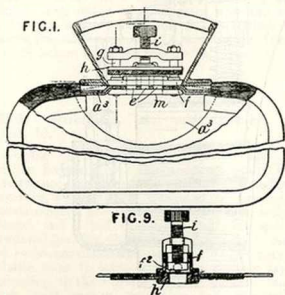

is provided with radial apertures *f*² at its lower end for the passage of water to the interior of the bag. Specification No. 6991, A.D. 1904, is referred to.

2792. British Thomson-Houston Co.,
[General Electric Co.]. Feb. 5.

Heating by electricity.—Relates to electric heating devices of the kind described in Specification No. 25,009, A.D. 1893, especially applicable to cigar lighters. A resistance conductor is wound in a series of parallel coils 4 supported on a ledge 5 in a plug of insulating material. One end of the resistance coil is connected to a terminal 3, and the other end is connected to the screwed metallic portion 2 which fits into a lamp socket. The coils are separated from each other by strips 9 of insulating material, such as mica, and are covered by a shield 10 of similar material. The shield rests on the strips 9 and serves as the heat-transmitting portion

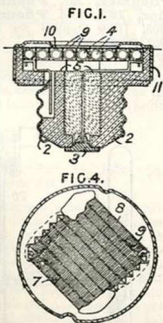

of the device. To ensure an even distribution of heat, the turns of the outer coils 7, 8 are arranged more closely together than those of the inner coils. A protective retaining cover 11, which fits over the shield 10, has a central opening. The cover is raised out of contact with the shield except for edges of the central opening which bear upon the shield.

2811. Gardner, R. C., [Bréman, A. C.].
Feb. 5.

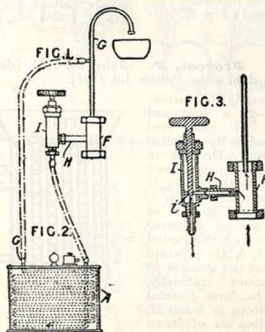

Heating liquids.—Relates to a combination of an electric liquid heater and a liquid-distributing apparatus, by means of which water may be delivered at a temperature at or near the boiling-point or in a cold state. The heater A consists of a copper tube upon which is spirally wound a ferromagnetic wire, through which an electric current passes so as to heat the liquid flowing through the tube. The tube is first covered with a ribbon of amianthus, and the wire wound upon this covering. The spaces between each turn of the wire are also filled with amianthus. The tube is arranged in a casing containing tow or leaves of amianthus. The distributor, which is movable, consists of two metal casings F, I, connected by a passage H. The casing F is connected at its lower end to the cold-water supply, and at its upper end an outlet pipe G is fitted. The casing I, which communicates at its lower end with the heater A, has a valve arranged to control the flow of water to the heater. Instead of flowing directly through the casing F, part of the water supply may pass through the passage H and casing I to the heater, whence after being heated it rejoins the cold water in the outlet pipe G, and is mixed therewith.

- 2912. Jolles, L.** Feb. 7, 1905, [date applied for under Patents Act, 1901]. Void. [Published under Patents Act, 1901.]

Heating buildings &c.; heating liquids.—Tubular joints between plates are made by pressing or stamping out necks *b* from two plates *a*, Fig. 1, and welding the necks together, as shown in Fig. 2.

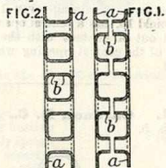

- 3010. Provost, P.** June 26, 1905, [date applied for under Patents Act, 1901].

Heating by steam circulation.—In a drier and heater of the kind described in Specification No. 5342, A.D. 1905, in which grain passes down through vertical tubes in a steam-heated casing 1, these tubes, the ends of which are set in upper and lower horizontal plates 4, 5, are provided with annular grooves or indentations externally, so as to form internal raised hoops or bands 12. The tubes are of drawn metal. Steam inlets and outlets are provided, and the casing is formed of a funnel shape contracting downwards, above and below the diaphragms 4, 5. Valves may regulate the flow of grain.

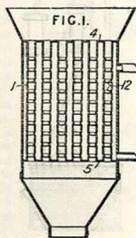

- 3175. Bourne, J. C., and Rees, G. H.** Feb. 9.

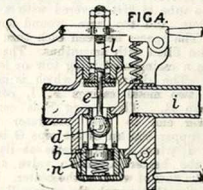

Steam traps.—Relates to steam traps in which the valve consists of a free ball enclosed in a cage carried by the trap head. In a trap of the Geipel type, as shown in Fig. 1, the valve seating is formed in one extremity of the slotted cage *b*. The ball *d* normally closes the seating, disengagement of the

ball being effected in the usual manner. The valve-depressing spindle *e* is caused to bear upon the ball by a pivoted spring-controlled arm *f*. Fig. 4 shows a trap in which the valve is kept to

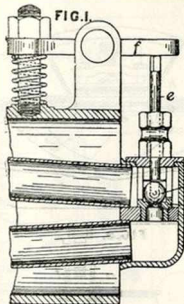

its seat by the pressure of steam and water below it. The contraction of the pipe *i* causes the spindle *e* to be depressed, allowing water to flow to the outlet. The valve seating is formed in the upper part of the cage. The cage is closed below by a plunger *n* forced upwards by a spring which prevents damage in the event of the valve being unduly depressed.

- 3314. Pfeumer, E., Pfeumer, H., Pfeumer, H., Pfeumer, M., Pfeumer, F.** Feb. 27, 1905, [date applied for under Patents Act, 1901].

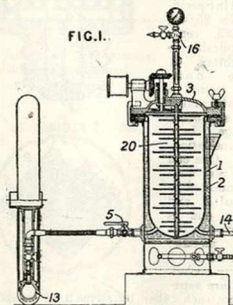

Digesters for producing a spongy, gelatinous filling-material for tyres. The material is heated by

means of a water bath 2 in the vessel 1, which is provided with a mechanical stirrer 20 and hermetically closed by a lid 3. Air is forced in at the opening 14, or gas may be generated in the material by means of tartar emetic or like gas-generating substance. The outlet communicates with the tyre 13 through a three-way cock 5. To obtain the desired pressure in the vessel 1, air may be forced in at 16 before using the passage 14.

3316. Voelker, A., and Sulser, J.
Feb. 10.

Heating by electricity.—Vessels, radiators, and the like, for heating by electricity, are coated with a resistance layer by painting them, repeatedly if necessary, with a wash composed of powdered, retort carbon, a binder such as tar, sugar, or sodium silicate, and a bad conducting material such as powdered fire-clay, the last-named serving to make the resistance discontinuous. The binder may be volatile so as to leave a porous resistance layer. According to the Provisional Specification, lamp-black, peat carbon, or other bad conducting carbonaceous materials may be used, with or without a non-conducting substance; the surface to be coated may be porous; and the resistance layer may be graduated in thickness where the terminals are attached.

3353. Sankey, C. H. Feb. 12.

Non-conducting coverings and compositions.—Silica bricks, tiles, lumps, &c. are made from a mixture of calcined and finely-ground silica, ground coke, and a fibrous combustible material, together with sodium silicate or other suitable flux. After being moulded, they are dried and fired. The articles thus made are fire-proof, non-conducting, sound-resisting, and porous. They may be faced by dipping in fire-clay or neutral material, such as graphite, carbon, carborundum, or the like, together, separately, or in combination with sodium silicate.

3465. Cross, J. W. Feb. 11, 1905, [date applied for under Patents Act, 1901].

Heating gases.—In engines actuated by mixed steam and a gaseous medium, such as air, the steam and air, instead of being mixed together and then heated, are heated separately and then mixed. Fig. 1 shows the apparatus as fitted in the smoke-box of a locomotive. The air and steam are heated in the separate nests of bent tubes *m*, *k* connecting compartments in the headers *d*, *e*. Transverse partitions in the compartments divide the nests of tubes into groups in series. Pipes connect the outlet openings with a mixing-chamber *t* having radial gills on the outside. Separate headers may be employed with each set of tubes. In a modification, the two sets of tubes are arranged end to end, the steam tubes *k* being nearer the boiler. Fig. 8 shows another

modification in which sinuous tubes *m* connecting separate headers 2, 3 are employed for heating the air.

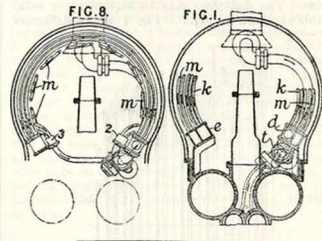

3495. Hart, W. Fairburn. [Whelock, F. H., Offerdinger, H. L., and Fenton, D. H.]
Feb. 13.

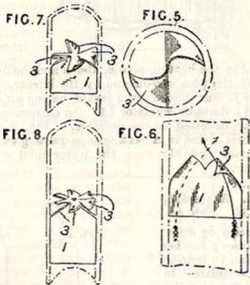

Heating buildings.—Relates to circulation accelerators and deflectors adapted to be fitted in the pipes of hot-water heating-systems for rooms, dwellings, stores, or other buildings, so as to mix and thereby to equalize the temperature of the circulating water. The deflectors, which are shown in detail in Fig. 5, 8, may be arranged in a portable radiator, as shown in Fig. 1, or in a permanent installation as shown in Fig. 2. A deflector has lateral concavo-convex wings 3 projecting from the opposite parallel faces of a body

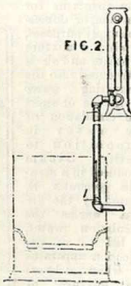

piece 1. The wings, which taper from their bases to the tops, incline inwards and upwards to direct the current of liquid to the centre of the pipe. The deflectors may be stationary, or rotatable as shown in Fig. 8. Fig. 1 shows deflectors

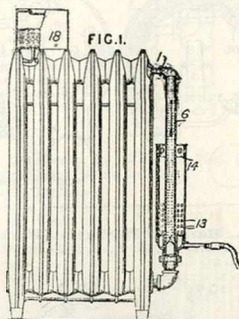

located in the heating-pipe 6, above and below the part of the pipe surrounded by the burner. This burner is surrounded by a jacket having air inlets 13 and a draught regulator 14. An expansion tank 18 may be fitted to the radiator. Fig. 2 shows deflectors placed in a heating-pipe passing through a furnace and also near the water inlet of the radiator.

3694. Russell, J. N. Feb. 14.

Heating by water circulation; heating buildings; heating water.—Relates to hot water circulation apparatus for warming or domestic supply purposes, in which a mixture of steam and air is introduced into the circulating water to induce or assist the circulation of the water in opposition to gravity. Steam produced in a separate generator E, heated by the fire that warms the circulation water, is led to an air-injection apparatus J, which delivers the mixture of steam and air by

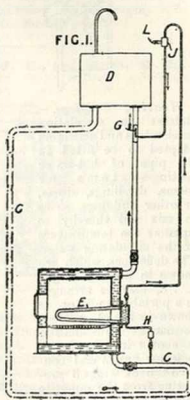

means of an upwardly-turned nozzle G into the rising main. The air-injection apparatus is preferably situated above the level of the water in the tank D to avoid flooding. The air inlet L may be provided with a non-return valve to prevent the escape of steam. Water may be supplied to the generator from the return main C through a valve-controlled pipe H. The steam or air escapes through the tank D.

3793. Sandvoss, H. Feb. 15.

Steam traps; thermostats.—Apparatus for indicating or regulating the temperature and flow of liquids consists of a cylinder d containing mercury or other suitable fluid which is influenced by the temperature of the liquid entering at a, and, through a float or piston e, controls the outlet valve f. A spindle k is attached to the valve for indicating or alarm purposes, and is provided with a flexible sleeve g to prevent escape of liquid. The contrivance is stated to be applicable for regulating exhaust-water outflows, steam or hot-water heating-apparatus, and bath-heating apparatus.

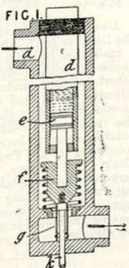

3833. Haines, R. T., and Gould, F. Whit-
Feb. 16.

Boiling-pans.—Relates to apparatus placed in wash boilers to cause an automatic circulation of water over and through the clothes to be washed. The liquid passes up through the tube 2, over which slides a pipe 3 surmounted by a cap 4, from which the liquid issues and falls on the clothes surrounding the weighted conical base 1. Corrugations or channels 8 prevent the clothes from obstructing the apertures in the base. The dirty water may be withdrawn from the boiler through a pipe 6 by pressing the cap 4 on to the inner tube 2.

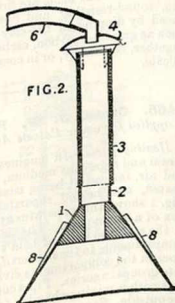

4348. Saunders, S. Feb. 22.

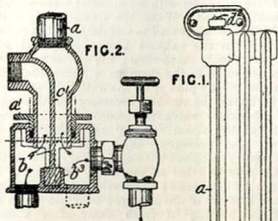

Heating buildings &c.—In a swing radiator constructed of sections connected with push or screw nipples, one section, preferably the end one *a*, contains a divided waterway which forms part of the vertical pivotal support. In Fig. 1, the end section is shown supported by a trunnion *a'* at the top; it rests at the bottom upon the shoulder *b'* of the tubular waterway *b* divided into two by the web *c*. A gland *a'* is provided to make the joint watertight. In a modification, Fig. 2, the end section rests upon a footstep bearing *b'* contained in a box, divided into two chambers by a partition *b'* and a web *c'* upon the tubular extension of the end column.

4349. Saunders, S. Feb. 22.

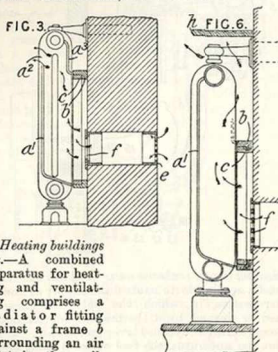

Heating buildings &c.—A combined apparatus for heating and ventilating comprises a radiator fitting against a frame *b* surrounding an air inlet in the wall. The radiator sections are provided in the front with webs *a'*

extending at the back to the frame *b* and at the front nearly to the top of the radiator, leaving spaces *a'* for the escape of the warmed fresh air. Webs *a'* are also provided at the back as shown. Fresh air enters through a grating *e* and passes through a hit-and-miss valve *f* and through a filtering-screen *c* of gauze or fabric fitting into the frame *b*. The radiator is pivoted at one side so that it may be turned away from the wall for cleaning purposes. Fig. 6 shows a modification in which the webs *a'* completely enclose the front of the radiator, the fresh air escaping at the back as shown, being deflected by the mantle *h*. The radiator sections are cast with the webs *a'* on each side, the webs butting together when the sections are fixed in position; or they may be provided with webs on one side only, the web on one section butting against the face of the next section. Instead of the valve *f*, a valve may be fitted to the radiator.

4433. Hardy, H. Feb. 23.

Thermostats. In apparatus for indicating and regulating the temperature of ovens &c., the difference in the expansion of two pieces of metal is transmitted through a magnifying device to a pointer moving over an indicating dial and also to a valve for regulating the gas or oil supply. Two metal tubes 1, 3, Fig. 1, of different coefficients of expansion are connected together, one inside the other, at one end by a cap 2. To a bracket 4 on the other end of the outer tube 1 is pivoted a lever 5, to which is also attached at 5' the end of the inner tube 3. The free end of the lever 5 is connected by a cord 6 passing round a pulley to the toothed rack 7, which engages with a pinion 9 carrying a pointer 10. In the case 8 the temperature of the tubes 1, 3. The upper end of the rack 7 is connected by a rod 12 to a tube 13, a rod 14 which slides in this tube being adjustably secured thereto by a screw 17 working in the projections 13', 14'. The rod 14 is connected by a wire 15 to the rod 16 of the regulating-valve shown in Fig. 2. This rod 16 is attached to the piston 18, which controls the supply of gas or oil through the port 19. The valve is sealed by a flexible diaphragm 22 bolted between the valve casing 21' and a metal ring 23. This diaphragm is secured to the rod 16 by nuts and washers 24 to prevent escape of gas or oil. A small hole 18' through the piston enables the pressure on both sides to be equalized. To a plate 25 under the valve casing is attached a pulley 26 for the cord of a counterpoise 28 attached to the rod 16. As a modification of the magnifying device, the difference in the expansion of the metals

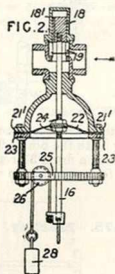

is communicated by a wire in a flexible tube to an horizontal lever attached to the indicator case 8. In another modification, shown in Fig. 4 the movement of a similar wire 29 is magnified by a series

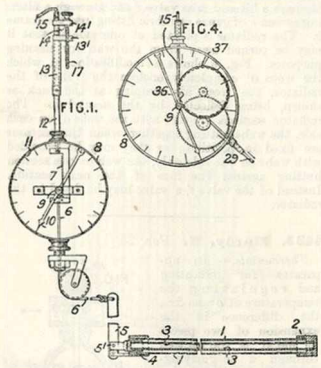

of toothed wheels and pinions, in the case 8, engaging with the pinion 9. The last toothed wheel 36 carries a drum 37 round which is wound the cord 15 for operating the valve.

4475. Mackay, R. Feb. 23.

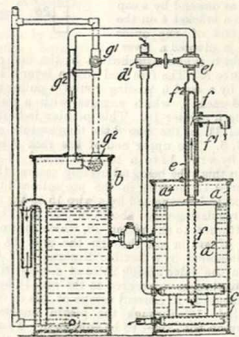

Heating water.—Apparatus for heating water for refreshment houses &c. comprises a boiler a heated by a steam coil e and fitted with a waste

steam pipe e, which encloses an open draw-off pipe f and communicates with a condenser b, from which the heater is fed. When the steam-supply valve d¹, which is so connected as simultaneously to close a valve e¹ in the exhaust pipe e, is opened and the water supply valve closed, the pressure of the steam generated in the chamber a forces the boiling water up the pipe f, to the outlet f¹, and cannot rise above the amount necessary for this purpose. A safety valve is therefore not required. Closure of the steam valve d¹ opens the valve e¹, releases the pressure, and stops the flow. Sprinklers g² supplied with cold water by a push-valve g¹ may be fitted to accelerate the release of pressure by condensing the steam. A bell a² and an annular space a¹ are arranged to retain steam to assist the heating of fresh water after a considerable quantity of hot water has been drawn off. A hole f² in the pipe f allows a slow escape of steam to keep the outlet pipe f¹ warm.

4490. Raud, E. Feb. 23.

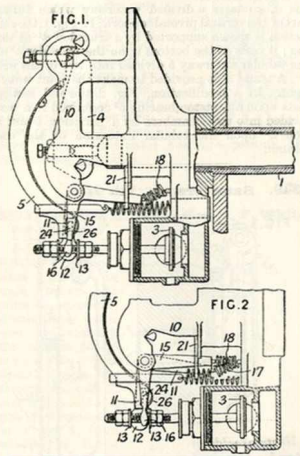

Heating water; thermostats.—Relates to thermostats, applicable to control the supply of fuel to water-heaters, in which the valve is abruptly closed or opened by a thermostatic device acting through spring-influenced lever mechanism. Fig. 1 shows the apparatus, the fuel valve 3 being open; Fig. 2 shows part of the valve-closing mechanism in an intermediate position; Fig. 3 shows the position of the parts when the valve is closed.

Pivoted to the frame structure 10 are two crank levers. One lever 11 is provided with a head 12 fitting closely between two collars 13 on the valve stem. The other lever 15 has a smaller head 16 possessing a certain amount of play between the collars 13, but on the side of the valve stem opposite to the lever 11. The other ends of the levers are fitted with springs 17, 18, each of which exerts a thrust to keep the lever in contact with upper or lower stops carried by the plate 21. The lever 11 has no connexion with the multiplying-levers 4, 5, actuated by the thermostatic device 1, but the lever 15 is provided with a wing 24 making contact with a projection upon the lever. The wing is also in contact with a spring 26 carried by the lever 5. In operation, the expansion device 1 actuates through the levers 4, 5 the lever 15 by means of the wing 24, and moves this lever gradually to the position shown in Fig. 2, the spring 18 being then in a line with the points between which it acts. As the lever advances farther, it is tripped by the spring 18, the head 16 rapidly striking one collar 13. As the spring 18 is stronger than the spring 17, the lever 11 is actuated by the movement of the collars 13 and passing suddenly from one position to the other abruptly closes

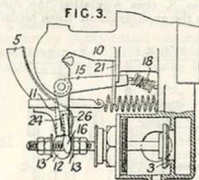

the valve. As the temperature falls, the lever 15 returns to the position shown in Fig. 2, being actuated by the lever 5 through the spring 26. Finally, the lever 15 moves abruptly to the position shown in Fig. 1, the lever 11 and spring 17 being moved through the collars 13 as before. The spring 26 permits the lever 5 to be moved without actuating the lever 15 when contraction of the expansion device proceeds beyond the limit for which the regulator is adjusted.

4581. Nathansohn, S. Feb. 24.

Heating by electricity; thermostats.

—A cushion or mattress for the application of heat and electricity for medical purposes is provided with conductors e, e' consisting of an asbestos core wound with a nickel-coil, insulated with asbestos and cotton yarn. Within the cushion is an automatic heat-sensitive switch which consists of compound bars m, n of brass and iron forming a fork. The pole k and the insulated piece g , which is connected to the other pole j by means of a fuse s , carry contact-screws p, r which make contact with the arms of the fork until the latter bend on attaining a sufficiently high temperature. The switch is arranged in a metal casing provided with a mica window. The heating-circuit may be arranged in two portions, so that the heating effect may be varied.

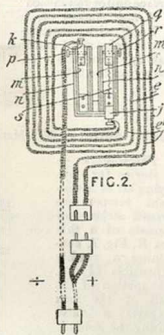

4647. Whiteley, J. E., and Peace, W. Feb. 26.

FIG. 1.

FIG. 2.

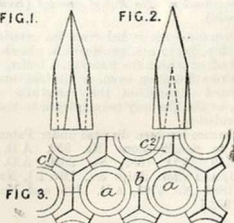

Heating air.—To facilitate the passage of air through the tubes a of apparatus for heating air for use in drying wood and textile materials, the spaces b between the tubes are occupied by wedge shaped or pyramidal pieces c^1, c^2 . Fig. 1 is an elevation of these pieces in the position c^1 , Fig. 2 an elevation of the pieces c^2 . A slightly modified form is adopted for heaters having their tubes arranged in square, as distinct from diamond formation.

4784. Lüsebrink, G. Feb. 27.

Steam traps.—The discharge pipe a is fitted with a body b which is formed with intersecting or zig-zag grooves on its surface, as shown in Fig. 1. In one modification, Fig. 3, the body is made hollow

to receive a piston *e*, which may be adjusted to uncover holes *S*, thus regulating the discharge. Fig. 6 shows the application of three pieces *i*, *k*, *l*,

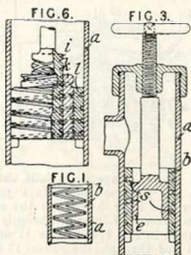

of which the first has intersecting or zigzag grooves, the other two having plain helical grooves. These arrangements allow water and air to pass, but prevent escape of steam.

4948. Taylor, H. E. Feb. 28. *Drawings to Specification. No Patent granted (Sealing fee not paid).*

Heating air.—Air is led from the exterior of a house, ship, &c. to a serpentine tube placed on the outside of, or within the water in, a boiler, on the outside of a fire-place, oven, or the like, and then distributed throughout the structure. Fans, screws, or the like may be employed to accelerate the circulation.

[Reference has been directed under Patents Act, 1902, to Specifications No. 952, A.D. 1856, No. 3119, A.D. 1857, No. 3690, A.D. 1874, [Abridgment Class Ships &c., Div. I.], No. 1282, A.D. 1883, No. 4783, A.D. 1898, and No. 4347, A.D. 1903.]

4982. Clayton, F. W. March 1.

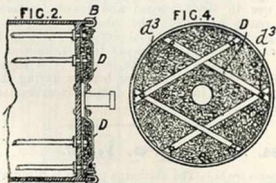

Non-conducting coverings.—Heat non-conducting mattresses are attached to the ends of steam-heated

cylinders employed, for example, in slashing, sizing, and calendering machines, or to the exposed portions of boiling-pans &c., by means of metal strips or plates held by clips or screws. The covering, for example, silk-waste coiled to form a mattress, is held to the cylinder end by clamps *B*, Fig. 2, or by *Z* shaped clips, to which are screwed metal strips *D* radiating from the hub. In the form shown in Fig. 4, adapted for use in calendering-machines, the strips *D* are held by the usual screws *d*, and, in another example, a metal plate or spring metal arms radiating from a clip secured to the shaft may be used.

5092. Holmes, A. B. March 2.

Heating by electricity.—

In electric heating-apparatus for rooms &c., employing incandescent lamps *a* as the heating-elements, the globe of each lamp is enclosed within a tube *c* which is open to the atmosphere at each end. The tube may be of metal, having its external surface polished to diminish radiation, and its internal surface dull or roughened; or it may consist of, or be lined with, earthenware or refractory material to absorb the radiant heat from the lamp, and impart it to the air passing up the tube.

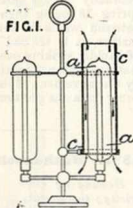

5238. Shiels, A. March 3.

Thermostats.—

A device for supplying air at a constant temperature to a carburettor consists of a thin box *K*, Fig. 7, containing a readily expandable fluid. The motion of the wall of the box actuates a valve closing the cold-air supply *K*²; warm air enters at *K*³.

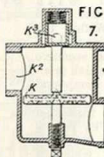

5348. Soddy, F. March 5.

Heating by electricity.—In apparatus for electrically heating substances to high temperatures in evacuated glass vessels, means is employed to prevent the radiation and conduction of heat to the walls of the vessels. In the form shown in Fig. 1,

the resistance coil i^2 surrounds the substance, e.g. calcium, contained in the vessel L, and is itself surrounded by a porcelain tube K, which thus protects the outer glass vessel B from radiation. If

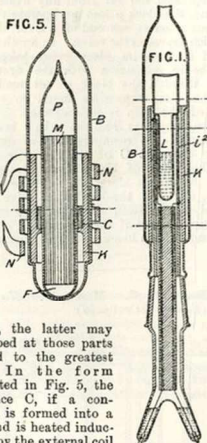

desired, the latter may be bulbed at those parts exposed to the greatest heat. In the form illustrated in Fig. 5, the substance C, if a conductor, is formed into a ring and is heated inductively by the external coil N traversed by an alternating current of high frequency. A core of iron wires M contained within a vessel P of porcelain, or of glass protected by mica, increases the effect.

As in the formed construction, a tube K protects the glass walls of the outer vessel B. The invention is stated to be more particularly applicable to the production of vacua by means of gaseous absorption by highly-heated substances as described in Specification No. 17,933, A.D. 1905, [*Abridgment Class Air and gases, Compressing &c.*].

5551. Stokes, J. T. March 7.

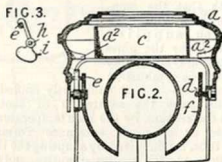

Heating buildings &c.—A radiator of ordinary construction is provided with a perforated cap a for containing a water-evaporating vessel c . The cap is supported by inwardly projecting brackets a^2 , and fastened in position by means of inward projections d, e on opposite sides of the cap. One or both of the projections may be adapted to slide or to screw inwards so as to engage with the members f of the radiator. In another arrangement, one projection engages with a catch, shown separately in Fig. 3, which is attached to a radiator member. The catch is inaccessible when the cap is in position except for a head h formed for the purpose of taking a key. The catch is pivoted and held in position by its own weight against a stop i .

5841. Fullerton, Hodgart, & Barclay, and Liversedge, A. J. March 10.

Digesters; boiling-pans.—Fat-melting pans or digesters and oil boiling and distilling apparatus are mounted with their axes at a considerable angle, preferably between 30 and 40 degrees to the vertical. The form shown in Fig. 2 is provided with a jacket E to which steam is admitted by F and the fat is run off at N, the exhausted tissues being removed by means of a door G. A pipe L serves for the exhaustion of the vapours which are evolved. Internal heating-pipes running parallel to the axis of the cylinder may also be employed.

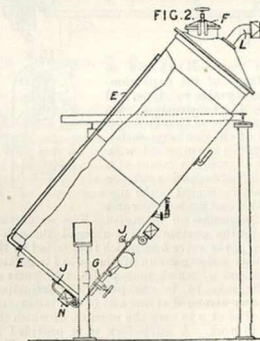

5854. **Brünler, O. H. U.** March 10.

Heating water.—In burners of the type described in Specification No. 18,563, A.D. 1903, [Abridgment Class Steam generators], in which the flame burns under water, the deposition of soot in the water is prevented by forming the burner tube *g* of such a length that the combustible and the compressed air supplied respectively by the pipes *c*, *d* become so highly heated before combustion that the flame is not sufficiently cooled by the water to cause the separation of soot. The gradual destruction, by the high temperature of the chamotte or fire-proof substance forming the burner tube, is minimized by adapting the thickness of the tube *g* to the quality, quantity, and pressure of the air and the combustible. The burner tube *g* may, however, be constructed of very thick cast iron, in which case a point is reached at which the further burning away of the tube is prevented by the cooling effect of the water. The burner and the water may be enclosed in a transparent casing *h*, from which the steam escapes through a pipe *i*.

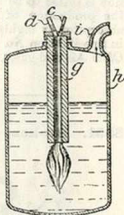

6004. **Paterson, R. H.** March 12.

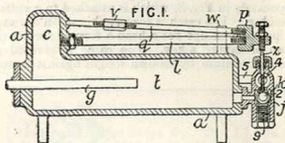

Steam traps.—Relates to steam traps of the expansion-tube and movable-rod type, and consists in constructing the expansion tube so that it forms no part of the discharge outlet. A reservoir *a* is connected with the steam system by means of a pipe *g*. The expansion tube or tubes *l* are connected to the upper portion *c* of the reservoir and are in communication therewith. The water that collects in the portion *b* is discharged through a valve-box *j*, the valve *k* in which is operated by the contraction and expansion of the tube *l* regulated by a tie-rod *g*, which may be in two parts as shown or may be in one piece, the adjusting-screw being arranged at one end in the latter case instead of as at *v* to vary the pressure at which the trap is to work. A guide-fork *w* is provided to limit the side movement of the tube and rod. The

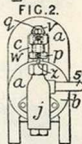

rod *z* operating the valve is fluted at its lower end to permit the water to flow down the exit tube *4*, 5 when discharging. A spring *9* is provided, bearing against a valve-protecting cage *2* to replace the valve if depressed too far from any cause. In a modification, the block *p* does not operate the valve directly, but actuates one end of a lever the other end of which depresses the valve. In another form, no tie-rod is used, its place being taken by a second tube in connexion with the first at its outer end through the block *p* but made of a different and less expansible metal so that the operation of the trap is not affected. In this modification, a by-pass from the tube *g* is directed towards one of the openings of the expansion tubes into the part *C* of the reservoir so that towards the finish of the discharge steam will enter and be driven along the tubes, expanding them and shutting the discharge valve. The Provisional Specification describes the use of a wedge device instead of the tie-rod for obtaining the depression of the block *p* on the contraction of the tube.

6031. **Barter, C.** March 13. *No Patent granted (Sealing fee not paid).*

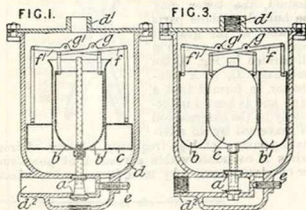

Steam traps.—A steam trap of the float type is adapted for use with steam heating-systems, and particularly for systems in which steam below atmospheric pressure is employed. In the arrangement shown in Fig. 1, the casing *d* communicates with the heating-system through the aperture *d'*, the pump being attached to the outlet *d''*. It contains the bucket *b*, which is secured to the hollow spindles of the valves *a* and which is provided with the opening *b'*. The annular float *c* surrounds the bucket. A by-pass allows, when necessary, blowing through. The valves *a* are of different areas to produce a closing tendency. Levers *f*, *f'*, pivoted at *g*, *g'*, connect the bucket with the float. When little or no water is present, the float closes the valve, but, on an inflow at a greater rate than can escape by the openings *b'*, the bucket by its weight of water opens the valves and the water is discharged. Should the inflow not exceed the outflowing capacity of the openings *b'*, the water rises within and without the bucket, the float is raised, and the water in the bucket is allowed to become effective so as to open the valves. In the form shown in Fig. 3, the bucket is made annular so as to enclose

the float *c* while the valves are arranged to open when they are lifted. When steam above atmospheric pressure is employed, a solid valve stem is employed. A single valve may also be employed instead of an equilibrium valve.

6057. Göhrig, H. March 13.

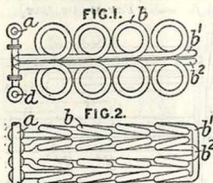

Heating gases.—A tubular apparatus for heating gases consists of a series of V-shaped tubes *b'*, connected to inlet and outlet headers *a*, *d*, and formed with a series of bends or loops *b* arranged along their lengths, either close together as shown, or leaving spaces between them. Specifications No. 2624, A.D. 1880, and No. 21,936, A.D. 1902, [Abridgment Class Steam generators], are referred to.

6192. Lindemann, O., [Körting Akt.-Ges., Geb.]. March 14.

Steam traps.—

Relates to steam traps of the type in which the movements of an open float control the discharge, and in which the valve is moved from its seat by a roller carried by the float travelling along a curved surface so arranged that, as the float sinks, it acts at a decreasing leverage, to produce an increasing movement of the valve. Fig. 2 shows the valve mechanism at the beginning of the discharge. The float-rod *h*, having stops *p*, *q*, is forked at its upper end to carry a roller *i*, and is pivoted to a link *k*, itself pivoted to the trap casing. The valve *v* is actuated by a lever *m* pivoted to the discharge tube *e*, and formed with a curved surface *r*, as shown, at its upper end, over which the roller *i* travels. As the float falls, the

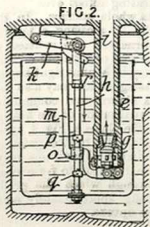

roller *i*, swinging round the pivot of the link *k*, to which the upper part of the surface *r* is almost tangential, causes the valve to open slowly at first, but subsequently, as the roller reaches the flatter portion of the surface, more rapidly, the valve being finally opened wide by the upper stop *p* on the float-rod pressing upon a boss *o* on the lever *m*. On the completion of discharge, the lower stop *q* effects the closure of the valve. The roller *i* may be fixed on the lever *m*, and the surface *r* on the rod *h*.

6193. British Thomson-Houston Co., [General Electric Co.]. March 14.

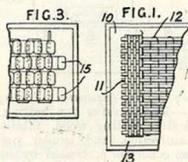

Heating by electricity.—Resistances, stated to be applicable for electric heaters, are constructed by supporting a resistance wire on refractory supports, which are cemented to a suitable base by means of enamel or other soft material hardened by heating, the conductor not being embedded in the enamel. In the form shown in Fig. 1, the resistance wire 12 forms the weft of a fabric of which asbestos cords 11 form the warp. Additional weft threads of asbestos 13 may be added. The asbestos is fastened by enamel to the base 10, of cast iron or other suitable material. In another form, shown in Fig. 3, the resistance wire is supported on refractory blocks 15, fastened to the base by enamel.

6288. Burton, C. E. March 15. Drawings to Specification.

Heating liquids.—Tea, coffee, or milk pots, urns, mugs, jars, milk churns, &c. are jacketed or are fitted with a fixed or removable liner or with one or more compartments, each space thus formed being provided with an inlet, closed by a screw cap &c., for a heating-medium.

[Reference has been directed under Patents Act, 1902, to Specifications No. 3228, A.D. 1861, No. 1950, A.D. 1865, No. 3429, A.D. 1886, No. 8310, A.D. 1890, and No. 21,140, A.D. 1891, [all in Abridgment Class Tea &c.], No. 11,748, A.D. 1893, [Abridgment Class Milking &c.], No. 21,448, A.D. 1894, [Abridgment Class Tea &c.], No. 8767, A.D. 1897, [Abridgment Class Milking &c.], and No. 15,031, A.D. 1899, [Abridgment Class Tea &c.].]

6681. McWhirter, C. March 20.

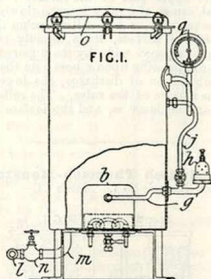

Digesters; heating-apparatus; heating by steam circulation.—In apparatus for heating, steaming, and chemically treating wood, fabrics, &c., for drying, disinfecting, and similar operations, a closed steam generator *b*, heated by steam-heated coils or the like, is arranged in an oven containing the articles to be heated. The steam generator is filled through a pipe *g* fitted with a safety-valve *h*. The steam passes into the oven through a pipe *j* provided with a regulating-valve. A vacuum may be produced in the oven by means of an ejector *l* communicating with the apparatus by a pipe *m* and valve *n*. A steam-tight cover *o* is held in position by bolts. A pressure gauge *q* may also be provided. Specification No. 14,869, A.D. 1904, is referred to.

[Reference has been directed under Patents Act, 1902, to Specification No. 4636, A.D. 1885, [Abridgment Class Medicine &c.]

7065. Welch, W. H., and Frost & Co., H. March 23.

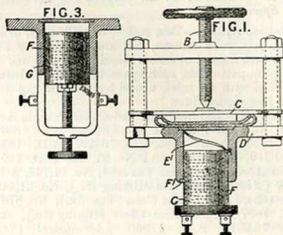

Heating by electricity.—An electrically-heated portable vulcanizer comprises a press or clamp such

as B, C, D for holding the portion of the tyre &c. to be operated upon, one or both of the pressing-plates being heated by an adjustable electric plug such as F, G, Figs. 1 and 3. In the form shown in Fig. 1, the plug is adjusted by rotation, studs *F*¹ bearing in a helical groove *E*¹, while in the form shown in Fig. 3 a guideway prevents rotation.

7076. Lechler, P. March 24, 1905, [date applied for under Patents Act, 1901].

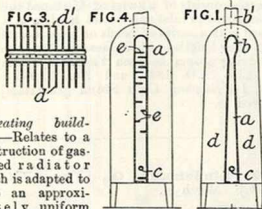
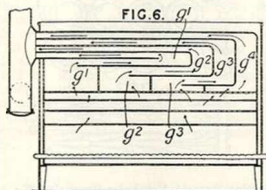

Heating buildings.—Relates to a construction of gas-heated radiator which is adapted to have an approximately uniform heating effect over its whole surface.

In the construction shown in Fig. 1, a casing *a* tapering upwards is heated by burners *c*, and is fitted with radiating ribs *d*, preferably of aluminium, the ends *d*¹, Fig. 3, of which may be bent at right-angles. The upper part *b* of the casing, which may also be of aluminium, is enlarged as shown, and communicates with the outlet *b*¹. Equalization of the heating may also be effected by baffle-plates *e*, Fig. 4, arranged within the casing, to delay the heated gases in the upper part of the radiator. Partitions may also be arranged within the radiator to form channels *g*¹, *g*², *g*³, *g*⁴, Fig. 6, through which the products of combustion pass along approximately equal paths before reaching the uptake.

7346. Row, O. M., and Royles, Ltd. March 27.

Heating water.—The water supply of swimming or plunge baths is purified, aerated, and reheated by a method similar to that described in Specification No. 10,865, A.D. 1903. The water is drawn off from the deep end of the bath *a* through the

1906]

ABRIDGMENT CLASS HEATING.

[1906

strainer *l*, pipe *b*, and pump *e* to the aerater *c*. Thence it passes to the filter *f* and the open tank *i*, from which it is supplied to the shallow end of the

bath through the heater *j*, which may be heated by exhaust from the pump and live steam from the boiler.

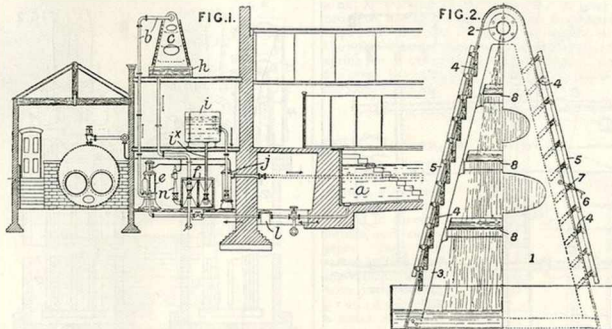

7390. Gesztosy, J., and Petravic, J. von. March 27.

Heating air.—The efficiency of compressed-air motors, particularly those used for propelling torpedoes, is increased by heating the air and mixing it with steam on its way to the motor. The air is stored in a reservoir *a*, which also contains a little water, and passes to the casing *f* of a combustion chamber *l*. Some of the air enters the liquid-fuel reservoir *g* through the holes *t* and spraying-nozzle *r* and is trapped therein. When the stop valve *i* is opened, and the pressure in the chamber *l* falls, fuel is forced from the spraying-nozzle *r*, mixes with compressed air, passes through a screen *n*, and is ignited by an igniter *j*. Another current of air passes upwards between the walls *l*, *f* and is moistened by water spray from the valve *e* and belt *u*; it mixes with and cools the products of combustion as they escape from the chamber *l*. The rate of flow of the liquid fuel depends upon the volume of the air space in the vessel *g*, which is determined by the quantity of liquid with which

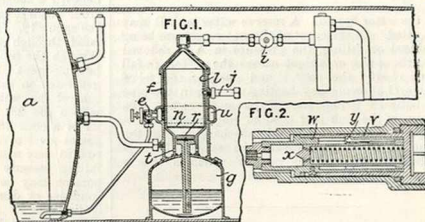

it is charged. The igniter *j*, Fig. 2, comprises a spring striker *x* held in a cocked position by a detent *y* and working in a piston *w* carrying a percussion cap. When the pressure falls in the combustion chamber on the opening of the stop valve *i*, the air that has accumulated inside the piston *w* forces the latter to the left, causing it to disengage the detent and release the striker.

7453. Barber, E. H. March 28.

Heating water.—Relates to apparatus for controlling the supply of steam or hot water to be mixed with water to be heated, by the pressure of

the latter. When the pressure in the water supply pipe *D* is normal, water enters the cylinder *A* and forces up the piston *B* against the action of the spring rod *L* or of a weight *P*. This motion is transmitted by means of a rod *K* to levers *J* and *J'*,

the former opening the cock F on the steam or hot-water supply E and the latter closing the escape outlet G so that the heating-medium passes to the bath or the like in the required proportion

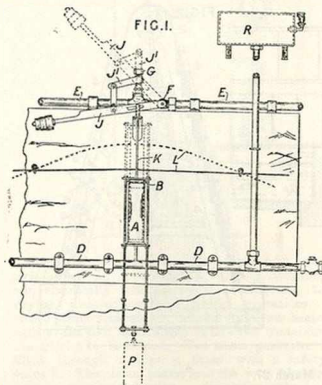

to the water heated. A reserve water tank R may be fitted. In the event of the water pressure being reduced or failing, the pressure in A is relieved and the spring or weight causes the piston to fall thus closing the cock F and opening the relief valve G allowing any heating-medium in the pipe E between F and the discharge to escape, the water in the tank R if such be employed preventing any liability of danger by discharging into the pipe D. In a modification, the escape valve G is formed as part of the valve F which is thus a three-way cock.

7610. Stott, J. March 29

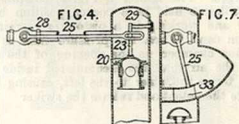

Heating water.—Comprises tubular apparatus for boiling water by steam, or gas, particularly applicable for tea or coffee making, and may include an arrangement by which the pressure of the steam evolved from the boiling water serves as a means of regulation. Figs. 1 and 2 are sectional front and side elevations of the apparatus. The

cold-water and steam-supply valves 3, 4 are simultaneously operated by levers by means of an engagement stop 5. The valve 4 allows steam to pass into the chamber 10. The water passes

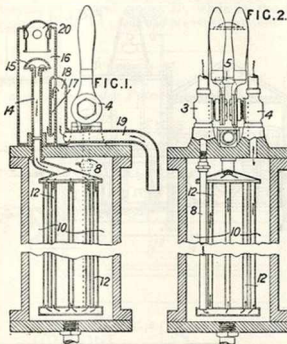

through a connexion 8 into a tubular arrangement 12, and is thence delivered from a pipe 14 beneath a mushroom head 15 into a chamber 16, from which it passes out through tubes 17, 18 to the spout 19. The water may, however, be circulated through the chamber 10 and the steam generated to escape and may also be adapted to control the water or steam supply by fitting it with a rod 23, Fig. 4, which actuates the lever 25 of a cock 28, or with a weighted chain which passes over a pulley controlling the cock. The rod 23 may also be furnished with a rising and falling pressure gauge 29. A condenser or evaporator may be provided above the valve 20 to condense or dissipate the steam arising from the boiling water. A modified regulator comprises a piston 33, Fig. 7, on the cock lever 25, moveable under the pressure of the liberated steam.

7630. Fulton, W. M. Jan. 30, [date applied for under Patents Act, 1901].

Thermostats.—In a damper regulator applicable in connexion with a low-pressure boiler for heating houses, and consisting of a collapsible vessel subject to the steam pressure, means are provided for compensating for the disproportionate resistance of the vessel to abnormal distortion, and for more readily connecting the damper lever to the vessel. In the construction shown in Fig. 2, the damper-lever 11 passes through the boss 6^a and rests in grooves cut in the ridges formed on the upper surface of a hollow rocker 10 pivoted at 9^a to a bracket 2 supporting the collapsible vessel 1 connected with the steam source. The plunger 4 is pivoted to the rocker at 32, both pivots 9^a, 32

having brass bearings to prevent corrosion. The compensating means comprises a plunger pivoted at 32 and urged forward by a spring within the casing 26 pivoted to the bracket at 39. Thus the greater

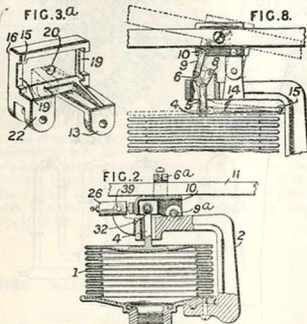

the upward movement of the rod 4 the greater will be the compensating vertical component of the force due to the spring. Another form of rocker is shown in Fig. 3^a, and consists of a plate 16 with flanges 15 recessed at 19 to receive the lever 11 which is then secured by a screw at 20, lugs 13, 22 being pivoted to the bracket and plungers as before. In the construction shown in Fig. 8, the plunger 4 is connected to the rocker 10 by means of links 5, and sector 6 pivoted at 8 a lever 14 pivoted at 15 being added to guide the plunger 4. Compensating means other than that shown in Figs. 2 and 3^a may be employed, an arrangement analogous to a fusee being described and illustrated in the Specification.

7835. Jeffery, W. April 2.

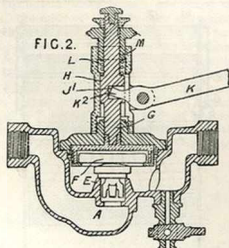

Steam traps.—A combined steam trap and relief valve is constructed with a spindle G, to the lower

part of which is attached a thermostatic capsule F which leans upon a valve E closing a passage A communicating with the steam-pipe. The spindle is kept in its normal position by means of a spring L bearing against a shoulder on the spindle and a nut M working in the sleeve H. A lever K is provided, having a tongue K' which bears upon the upper part of a slot J' cut in the spindle, so that the spindle can be raised against the action of the spring; or, if the pressure in the passage A becomes too great, the valve lifts, and raises the spindle in the same manner.

7917. Judson, G. R. April 2.

Heating liquids.

—Iron and other metallic pipes that have to be immersed in chemical liquids, such as the pipes used for steam-heating dyeing-vats, are coated with lead and are provided with a series of steam nozzles 8, Fig. 1, preferably of brass, screwed into orifices 7 extending through the coating and pipe. The shoulders 14, Fig. 2, of the nozzles are preferably undercut so that as the nozzles are screwed in the pipe the shoulders bite into the lead and force it against the screwed part of the nozzle, making a tight joint. The lead coating may be of uniform thickness, or a flat part 6, Fig. 3, may be formed thereon against which the flat shoulders 13 of the nozzles may bear. The outer ends of the nozzles may be formed square or with two flat surfaces 11 to enable them to be screwed into the pipe. The pipe may be formed with a closed end, or the end may be closed by a screwed plug.

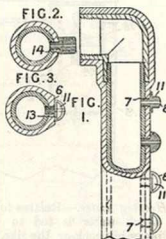

8058. Evans, T. W. July 15, 1905, [date applied for under Patents Act, 1901].

Heating buildings etc.—Relates to a valve stopper, the valve of which is applicable as a vent valve for radiators. The tubular valve stem m, having a lateral opening o, is fitted to slide in a metal plug c and screw-threaded externally to fit a nut j, the outside of which is screwed into the plug c. The parts having been assembled as shown, the stem m and nut j are rigidly connected. If the nut j is then turned in the proper direction, the head l of the stem m is

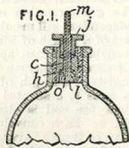

pressed against a packing-ring *h* and the valve closed. In a modification, the stem *m* and plug *j* are formed integrally, the head *l* being attached separately. In a further modification, the stem *m* and nut *j* are not finally connected rigidly and the screw-thread on the outside of the latter is omitted.

8070. Fenlon, H. T. April 3.

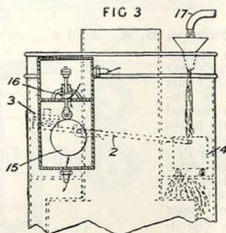

Heating water.—Relates to geysers of the type in which water is fed to the heater from an ordinary bib cock or the like, and the gas valve is actuated by the water entering the apparatus. A vessel 4, having a perforated bottom, is secured to a pivoted frame 2, and when empty is held in the raised position by balance weights 3. Admission of water from the tap 17 depresses the vessel 4, and actuates an eccentric 15 which opens the gas valve 16 after a definite traverse, thus allowing the water to fill the apparatus before the gas is ignited. Cessation of the water supply causes the vessel to rise, and allows the gas valve to close.

8183. Simmance, J. F. April 4.

Heating gases and liquids.—Relates to a gill formation or device for facilitating the transfer of heat between fluids in heat-exchange apparatus. The gill formation is constituted by a series of independent gill members. Each gill member consists of a length of wire brought to a form adapted to enable it, when applied to a tube, to become self-retaining thereon. One form, shown in Fig. 3, consists of a length of helically coiled wire having its ends *b, c* adapted to be interlocked together when the coil is placed in position as shown in Fig. 4. Each convolution of the coil may be circular, or it may have a portion thereof flattened so as to have a greater length of surface contact with the tube. Fig. 5 shows a gill member consisting of a length of wire bent to an approximately U-shape with a portion *e* of each limb outwardly bowed. These may be placed on the tubes, as shown in Fig. 7, so that the portions *e* embrace the

tubes. In a modification, the bend *f* is enlarged. Specification No. 11,532, A.D. 1895, is referred to.

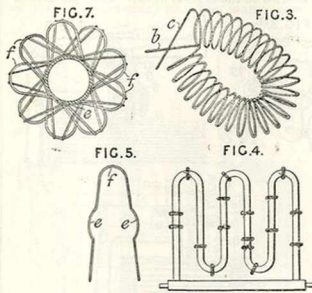

8241. Grauwe, F. de. April 5.

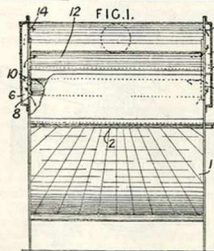
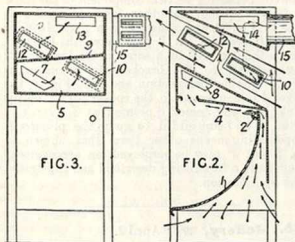

Heating buildings etc.—The products of combustion from the burner 2 of a gas stove or radiator, Fig. 1,

are led into chambers 5, 6 arranged at the sides of the stove and communicating with one another by cross-tubes, around which air circulates and becomes heated. Air is supplied to the burners from behind a reflector 1, and the products of combustion pass over a second reflector 4 and through openings 7, 8 into the chambers 5, 6, respectively. The chambers are divided into two compartments, the right-hand one 5 by an approximately horizontal partition 9, Fig. 3, and the left-hand one 6 by a vertical partition. The gases pass from the chamber 5 through an obliquely arranged tube 10 to the chamber 6, and leave by a passage 14 communicating with the flue. The gases entering the left-hand chamber pass through a tube 12 to the chamber 5 and escape to the flue by an opening 13. The flue 15, Fig. 3, may be slotted and provided with a corresponding sleeve for regulating the supply of air.

8395. Berry, E. April 7.

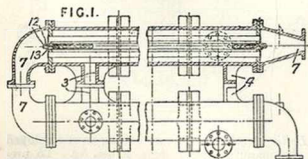

Heating water.—In tubular surface apparatus for heating water by steam, especially exhaust-steam feedwater-heaters, in which spirally twisted core-bars of square

or other equilateral cross-section are fitted within the tubes, the ends of the core-bars are reduced in section, screwed, and secured in place by nuts 12 and bridge-pieces 13. Fig. 1 shows the manner in which two or more heaters may be coupled in series. The casings are provided with connecting-branches 3 near one end, and at the other end with brackets 4 agreeing in length with the branches 3. The branches 7 connecting the ends of the casings have flanged faces which abut against each other in the same horizontal plane as the abutting faces of the branches 3 and brackets 4

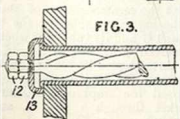

8457. Rivers, E. G. April 9.

Heating by electricity.—An electric heating-element or resistance consists of a plate of baked or kilned clay, uralite, or the like, in which are formed grooves B containing silicated carbon as a resistance. The resistance consists of soluble silica diluted with

water and mixed with carbon powder. The paste so formed is dried and subsequently heated. The electric contacts consist of metal bolts around

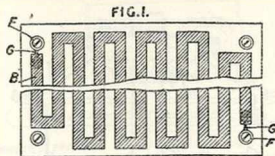

which pieces G of wire are twisted, the ends of the wires being embedded in the silicated carbon. The wires pass under metal washers F placed under the bolt heads.

8533. Simpson, W. S. April 9.

Heating air.—A portable apparatus for ventilating mines, rooms, &c. comprises a casing 1 fitted with a fan 5 and divided into upper and lower compartments 3, 2. The fan is driven by any suitable means, such as an electric motor, hot-air engine, &c., and forces the air of the room &c. down into the compartment 3, which contains a suitable liquid for moistening or disinfecting the air. The liquid may be heated or cooled so as to heat or cool the air. In a modification, the compartment 3 is closed, so that the air is only warmed or cooled. In a further modification, the bottom of the chamber 3 is made red-hot so as to impart a dry heat to the air and also to burn up any debris contained therein. The air may also be ozonized by providing suitable electric sparking-devices.

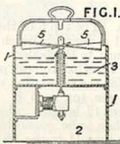

8739. Fleischer, J., and Bensmann, H. April 11.

Boiling-pans.—A boiler for use in washing or disinfecting linen &c. is fitted with internal perforated partitions 1, 2, upon which the clothes are placed; the washing is effected by steam generated in the lower part of the boiler, and by water discharged from a central circulating-pipe 11 into and through a perforated funnel 9 and distributed upon the clothes. The casing is constructed in two parts 3, 4, the intermediate partition 2 resting upon the latter. The lower partition is supported upon the bottom of the boiler by radial projections 14, which are cut away at their inner ends to allow water to enter the central tube 11 through serrations in its lower end. Steam is conveyed through a conduit 16 to the space below

the partition 2, which is provided with bars 15 to maintain such a space. A rotating or sliding sleeve 19 is fitted to close the outlet from this steam passage when the upper partition is not in

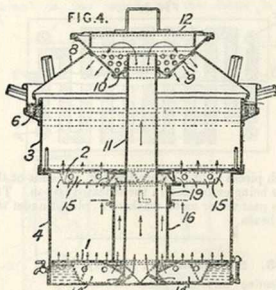

use. The top 8 of the apparatus dips into a water seal 6, through which any liquid overflowing may return to the boiler. The hopper 9 is formed with an inverted conical part 10 at its lower end to guide the circulating tube into place when putting on the top part 8. During normal working a cover 12 is fitted, which is removable to allow a siphon to be connected to the end of the circulating-tube 11 to run off the dirty liquid. The apparatus may be applied to disinfect clothes by steam, for which purpose the articles are placed on the lower perforated partition, and the circulating-pipe &c. is removed.

9032. Fullerton, Hodgart, & Barclay, and Liversedge, A. J. April 17.

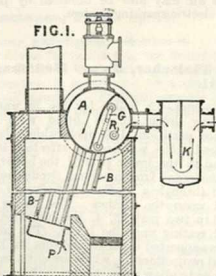

Heating liquids.—Exhaust steam to be employed

for heating, evaporating, &c., liquids is collected in a receiver in which it is superheated by a fire or waste gases. A suitable apparatus comprises a separator K, a divided drum A, and superheating-tubes B. A preliminary heating may be given to the liquid to be evaporated &c. by passing it through a serpentine pipe G placed in the receiver A. Water may be introduced, when desired, at R, and live steam at P.

9093. Peacock, W. April 17.

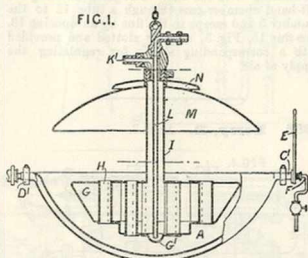

Boiling-pans.—Relates to boiling-pans employed in the manufacture of jams, jellies, &c. To prevent the caramelization of the thin film of liquid adhering to the sides of the hollow steam-heated vessel G and its tubes H, when the vessel G &c. is removed from the pan A, cold water or air is passed in through pipe K'. The pan A is mounted in bearings, C', D', and by means of a lever E may be tipped for emptying. Steam is supplied to the jacket through a pipe F, and to the vessel G through pipes K' and I. Condensation water collects at G' and escapes through a pipe L. A hood M has apertures under an auxiliary hood N to allow the escape of vapours.

9179. Schmidt, C. April 18, 1905, [date applied for under Patents Act, 1901].

Heating water.—In boilers having cast-iron elements a and a vertical fuel chamber h, louver-like bars b are provided between the water chambers i to direct the furnace gases into vertical passages c leading, as shown by arrows, into the passages d. The bars b, may be cast with the water chambers, or mounted on side bars g which are supported by projections k, or they may be inserted separately in suitably-arranged supports on the boiler elements. In the last mentioned arrangement, the bars may be made of any suitable material such as fire-clay.

(For Figures see next page.)

9179.

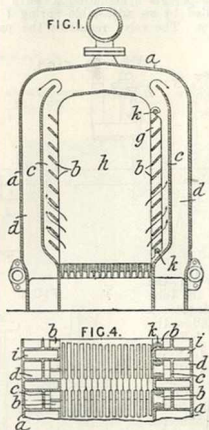

perpendicular position but to cut it off when placed flat down, and a switch actuated by hand pressure to maintain current on during use and to cut it off by means of a spring or weighted contact when the

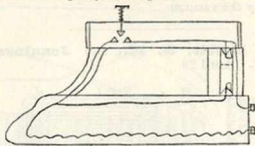

pressure is removed. A small mica window is provided in these irons, through which a portion of the heating-wire can be observed. The current may be reduced but not cut off entirely by the action of these switches.

9632. Crammond, A. April 24.

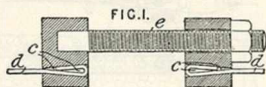

Non-conducting coverings.—The ends of metallic bands for securing boiler coverings &c. are drawn together and secured by an arrangement as shown. The lugs have tapered slots *c* to receive the ends of the band *d*, the ends being doubled as shown to prevent return. The lugs are provided with a screw bolt *e* by which they are drawn together.

9244. Read, H. J. April 19.

Heating by electricity.—Electrically-heated hand-irons are fitted with one or both of the following switches, namely: a mercury gravity switch to allow current to pass when the iron is placed in a

9643. Shurtleff, F., and Sleight, E. H. April 24.

Heating buildings &c.—In a steam heating-system, a return pipe 10 communicates with each radiator 8 and the air and water of condensation are drawn by means of an ejector 13 worked by steam from the supply pipe 7, and delivered through a condenser 14. The steam is there condensed, and the water returns to the boiler through the pipe 18, the check valve 19 and a pipe, which runs inside the return steam-pipe. The air passes upwards through the pipe 17 and escapes through a number of air vents

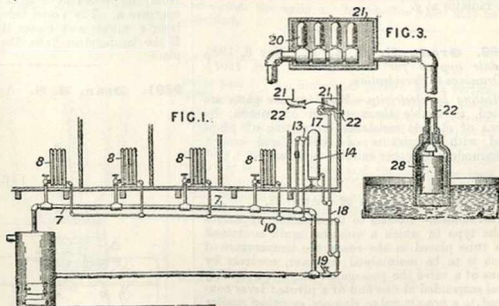

20, placed inside a casing 21 which communicates by means of a pipe 22 either with the open air or with the valve shown in Fig. 3; the valve has a float 28 which rises and prevents the return of air to destroy the vacuum.

9759. Nesbit, D. M., and Jennings, F. W. April 26.

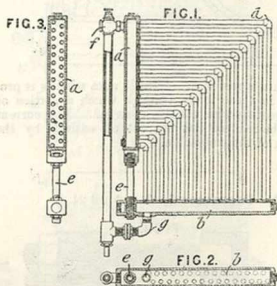

Heating buildings.—Steam and hot-water radiators are constructed with two headers *a, b*, arranged at right-angles to one another and braced by a tie-bolt *c*, between which are arranged rows of straight wrought-metal tubes connected by curved elbow joints *d*. Two or more sets of pipes may be arranged with the same headers, as shown in Fig. 2 and 3, or each set may have separate headers. A thermostatic valve, such as is described in Specification No. 12,850, A.D. 1904, may be fitted to govern the inlet *f*, the apparatus being regulated by the temperature of the outflow from the radiator at *g*.

9799. Grönwall, E. A. A. May 8, 1905, [date applied for under Patents Act, 1901]. Drawings to Specification.

Heating by electricity.—Blast-furnace gases are heated, to enable them to act on carbon, by means of electric resistances consisting of pipes filled with a mixture of carbon and emery, carborundum, or other suitable substance.

9861. Casse, W. F. E. April 27.

Thermostats.—Relates to thermostatic apparatus of the type in which a volatile liquid contained in a tube placed in the room, the temperature of which is to be maintained constant, controls by means of a valve the passage of water to a leaking vessel suspended at one end of a pivoted lever connected to a hot-air valve, damper, or other similar device. The change in volume of the volatile liquid, for example, methyl chloride, is transmitted,

through the medium of glycerine in the tube *y*, to a diaphragm *c* actuating a valve *f*, which is controlled by an adjustable spring *t* through levers *s, p*. The valve regulates the passage of

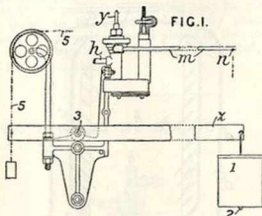

water from the pipe *h* to the tube *m*, which is pierced at *n* to allow the water to fall into a vessel 1, which has an aperture 2 and is suspended from the lever *s*; this lever is pivoted at 3 and connected with the hot-air valve &c. by the cord 5. If the temperature in the room rises, the valve *f* partly closes, thus retarding the flow of water to the tube *m*; consequently more water escapes from the vessel at 2 than is supplied from the aperture *n*. The vessel being thus lightened, the lever *s* moves and closes the hot-air valve &c. If the temperature falls, the reverse action takes place.

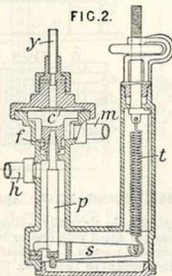

9891. Dean, H. S. April 27.

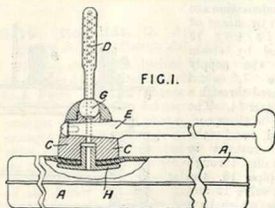

Hot-water bags and the like.—An enema apparatus

consists of a collapsible vessel A, similar in shape to a hot-water bottle, provided on one side with a ferrule C, to which a nozzle D is attached.

The device may be used as a water bottle by removing the ferrule and placing a screw cap over the connecting-plug H.

9909. Bruce, R. April 27.

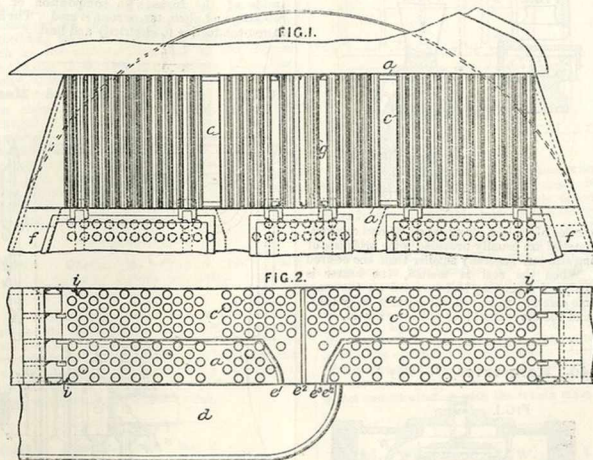

Heating air.—In air-heaters of the kind shown for steam boilers, the air is trained in its passage between the heating-tubes *c* by diaphragm walls *g* which serve also to stiffen the structure. The air enters the heater, which is situated in the uptake of a marine boiler, from the casing *d* by

openings *e*¹, *e*², *e*³, *e*⁴, and passes down the casings *f* to the furnace. The walls *g* are attached to the walls *a* by angle-irons which distribute the strain and stiffen the walls *a*. Iron baffles *i* also may be provided.

9927. Ure, J. A. April 28.

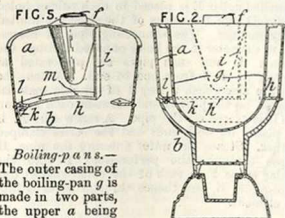

Boiling-pans.—The outer casing of the boiling-pan *g* is made in two parts, the upper *a* being capable of rotation relatively to the

lower part *b*. An horizontal baffle *h* and a vertical baffle *i* are fixed to the upper part, and the smoke has an exit at *f*. The lower casing is provided with two or more projections *k*, and the horizontal baffle has a number of holes *m*. Hence, when the chimney *f* has been placed in the required position relatively to the fire door, and the casing has been adjusted to cause two of the holes *m* to coincide with the holes in the projections *k*, the whole can be fixed in place by means of bolts *l*.

9939. Desgeorge, H. April 28.

Heating by electricity.—A sealing-device, for use with previously prepared seals *p*, consists of a heating-device such as an electric coil *r*

mounted on a handle *i*, and supported by legs *h*, preferably with a heat-conducting plate *f* between the coil *r* and the seal *p*, which is thus melted in place. For use with different sizes and

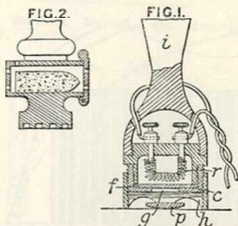

thicknesses of seals, a set of caps *c* of non-conducting material are usually provided with orifices *g* of varying size but generally smaller than the desired seal. When the seal is melted, the heater is removed, and a die may be impressed on the wax. In some cases, as in Fig. 2, the heating is by charcoal, and the die is combined with the heater.

10,140. Hargreaves, J. May 1.

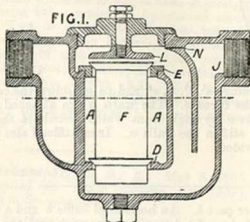

Steam traps.—The chamber *A* receiving the steam and water of condensation from drying-cylinders, steam-pipes, &c. contains a floating equilibrium valve *F* and seats *D*, *E*, the latter being removable. A plate *L* prevents abnormal rise of the float, and a vent *N* leading to the outlet *J* allows the escape of trapped air.

10,161. Hartenstein, H. L. May 1.

Non-conducting coverings and compositions.—Bricks &c. for lining electric or other furnaces are made of coke and lime with a stated small proportion of a mixture of asbestos and pitch, tar, or resin. Finely pulverized coke is mixed

with cream of lime, and the asbestos mixture, which has been mixed in the dry state, is thoroughly kneaded in. The slightly moist mass is moulded into bricks, blocks, or the like which may be dried, and if required for shipment, heated to 800° or 900° F. For applying the bricks to the inside of the furnace, a composition of lime, asbestos, and pitch, tar, or resin is used. The lining is non-conductive to electricity and heat.

10,201. Seagrave, G., and Harris, T. H. May 1.

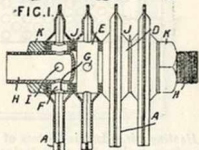
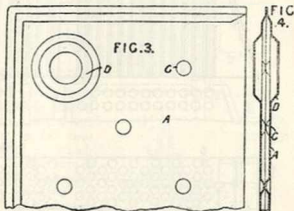

Heating water; heating buildings.—In a surface-heater constructed of sections, each element *A* is made from one piece of metal having four or more holed recesses *D*, and a number of depressions *C*. The sheet is folded so that the holed recesses *D* register, and opposing depressions *C* coincide with their hollows inwards and in contact. A holed channelled collar *E* is placed in each pair of holed recesses *D* and the edges of the sheet are jointed in any manner. The connecting-pipes *H* correspond in diameter to the holes punched through the elements *A*, and such pipes are perforated at intervals as at *I* from end to end. When the parts are assembled, a ring *J* of suitable material is placed on the pipe *H* and between each section *A* as it is placed on the pipe. A screw nut *K* is then placed on both ends and the series clamped together. Steam or water entering the pipe *H* escapes through the perforations *I* into the annular space *F* in each of the collar-shaped distance-pieces *E*, and thence through holes *G* into each element.

- 10,208. **British Thomson-Houston Co.**,
[General Electric Co.]. May 1.



Heating by electricity.—Conductors for electric heating-devices and the like are insulated by embedding them in a plastic insulating-material, such as the material described in Specification No. 19,035, A.D. 1905, [Abridgment Class Electricity, Conducting &c.], which sets into a hard silicate under special treatment. In the construction shown, the helically-coiled conductor is arranged in spiral form on a mica &c. plate 15, supported on a metallic dish-shaped base 14, enamelled or not. The turns of the spiral may be separated by strips 17 of mica. The receptacle is filled with a mixture composed of silica and a metal hydrate with or without finely ground asbestos or like fibrous material which is then subjected to a hardening-process.

- 10,222. **Metz, A.** May 4, 1905, [date applied for under Patents Act, 1901]. Drawings to Specification.

Non-conducting coverings and compositions.—Slabs and facings for buildings, ice-houses, cold-storage chambers, railway carriages, &c. are formed from a composition of asphalt, bitumen, and granular granite or stone, reinforced by a skeleton of expanded metal, trellis-work, perforated sheet metal, or crossed or interlaced wires.

- 10,310. **Reilly, J. F.** May 2.

Heating liquids.
—In the submersible type of apparatus for electrically heating liquids, means are provided for preventing contact between the wires and liquid and for permitting the circulation of the latter. The cylinder A, of porcelain or other suitable material, contains a concentric series of perforations C in which is laid the resistance wire X connected to insulated wires X' leading to an electric source. The ends of the cylinder are channelled to receive the wire X when passing from one perforation to the next, and are covered by screw caps D, D', a layer D² of cement, rubber, &c. being interposed. The apparatus, when assembled, may be dipped into a glazing-compound. Radial grooves G in the undersurface of the lower cap allow the liquid to circulate up through the central passage B.

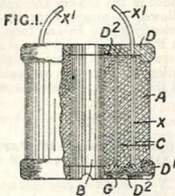

- 10,415. **Nesbit, D. M.** May 3.

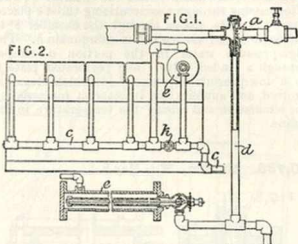

Heating buildings &c.—In the conversion of a hot-water heating-system into a steam heating-system, for instance in the manner described in Specification No. 22,451, A.D. 1905, a condenser or steam trap is provided on the return pipe of each radiator, heating-apparatus, or battery. Fig. 1 shows a steam trap e which may be of the type described in Specification No. 17,801, A.D. 1904, arranged so as to permit only water of condensation or vapour at a low temperature to pass to the jacket of the thermostatic device d, which controls the inlet valve a to the radiator. Fig. 2 shows a heating-battery having a steam trap e, which is connected to the common return pipe c of the battery, arranged about the level of the base of the heating-apparatus. A by-pass k allows direct communication with the return main.

- 10,725. **Westwood, J. W.** May 8.

Heating water; heating buildings &c.—A boiler for heating water for warming buildings and for other purposes is composed of two portions, in one of which the circulating water is heated, and in the other water is heated to a high pressure and passed into a chamber, where it evolves steam which is employed to aid the circulation and increase the temperature in the mains. The high-pressure portion a of the boiler is constructed of rectangular chambers surrounding the grate c, and is supplied with water from the low-pressure part b by means of

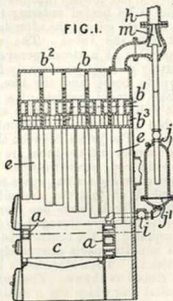

mounted on a handle *i*, and supported by legs *h*, preferably with a heat-conducting plate *f* between the coil *r* and the seal *p*, which is thus melted in place. For use with different sizes and

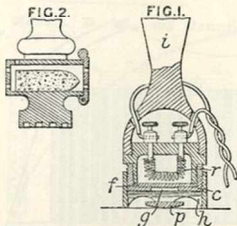

thicknesses of seals, a set of caps *c* of non-conducting material are usually provided with orifices *g* of varying size but generally smaller than the desired seal. When the seal is melted, the heater is removed, and a die may be impressed on the wax. In some cases, as in Fig. 2, the heating is by charcoal, and the die is combined with the heater.

10,140. Hargreaves, J. May 1.

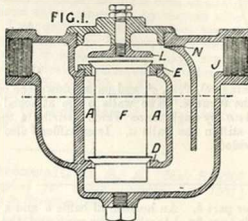

Steam traps.—The chamber *A* receiving the steam and water of condensation from drying-cylinders, steam-pipes, &c. contains a floating equilibrium valve *F* and seats *D*, *E*, the latter being removable. A plate *L* prevents abnormal rise of the float, and a vent *N* leading to the outlet *J* allows the escape of trapped air.

10,161. Hartenstein, H. L. May 1.

Non-conducting coverings and compositions.—Bricks &c. for lining electric or other furnaces are made of coke and lime with a stated small proportion of a mixture of asbestos and pitch, tar, or resin. Finely pulverized coke is mixed

with cream of lime, and the asbestos mixture, which has been mixed in the dry state, is thoroughly kneaded in. The slightly moist mass is moulded into bricks, blocks, or the like which may be dried, and if required for shipment, heated to 800° or 900° F. For applying the bricks to the inside of the furnace, a composition of lime, asbestos, and pitch, tar, or resin is used. The lining is non-conductive to electricity and heat.

10,201. Seagrave, G., and Harris, T. H. May 1.

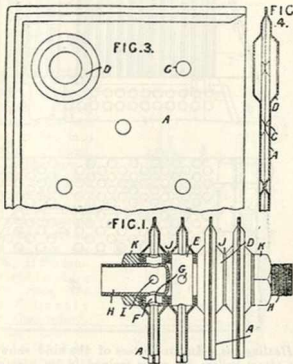

Heating water; heating buildings.—In a surface-heater constructed of sections, each element *A* is made from one piece of metal having four or more holed recesses *D*, and a number of depressions *C*. The sheet is folded so that the holed recesses *D* register, and opposing depressions *C* coincide with their hollows inwards and in contact. A holed channelled collar *E* is placed in each pair of holed recesses *D* and the edges of the sheet are jointed in any manner. The connecting-pipes *H* correspond in diameter to the holes punched through the elements *A*, and such pipes are perforated at intervals as at *I* from end to end. When the parts are assembled, a ring *J* of suitable material is placed on the pipe *H* and between each section *A* as it is placed on the pipe. A screw nut *K* is then placed on both ends and the series clamped together. Steam or water entering the pipe *H* escapes through the perforations *I* into the annular space *F* in each of the collar-shaped distance-pieces *E*, and thence through holes *G* into each element.

- 10,208. **British Thomson-Houston Co.**,
[General Electric Co.]. May 1.



Heating by electricity.—Conductors for electric heating-devices and the like are insulated by embedding them in a plastic insulating-material, such as the material described in Specification No. 19,035, A.D. 1905, [Abridgment Class Electricity, Conducting &c.], which sets into a hard silicate under special treatment. In the construction shown, the helically coiled conductor is arranged in spiral form on a mica &c. plate 15, supported on a metallic dish-shaped base 14, enamelled or not. The turns of the spiral may be separated by strips 17 of mica. The receptacle is filled with a mixture composed of silica and a metal hydrate with or without finely ground asbestos or like fibrous material which is then subjected to a hardening-process.

- 10,222. **Metz, A.** May 4, 1905, [date applied for under Patents Act, 1901]. Drawings to Specification.

Non-conducting coverings and compositions.—Slabs and facings for buildings, ice-houses, cold-storage chambers, railway carriages, &c. are formed from a composition of asphalt, bitumen, and granular granite or stone, reinforced by a skeleton of expanded metal, trellis-work, perforated sheet metal, or crossed or interlaced wires.

- 10,310. **Reilly, J. F.** May 2.

Heating liquids.
—In the submersible type of apparatus for electrically heating liquids, means are provided for preventing contact between the wires and liquid and for permitting the circulation of the latter. The cylinder A, of porcelain or other suitable material, contains a concentric series of perforations C in which is laid the resistance wire X connected to insulated wires X' leading to an electric source. The ends of the cylinder are channelled to receive the wire X when passing from one perforation to the next, and are covered by screw caps D, D', a layer D² of cement, rubber, &c. being interposed. The apparatus, when assembled, may be dipped into a glazing-compound. Radial grooves G in the undersurface of the lower cap allow the liquid to circulate up through the central passage B.

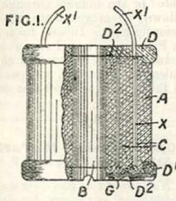

- 10,415. **Nesbit, D. M.** May 3.

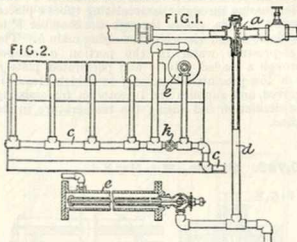

Heating buildings &c.—In the conversion of a hot-water heating-system into a steam heating-system, for instance in the manner described in Specification No. 22,451, A.D. 1905, a condenser or steam trap is provided on the return pipe of each radiator, heating-apparatus, or battery. Fig. 1 shows a steam trap e which may be of the type described in Specification No. 17,801, A.D. 1904, arranged so as to permit only water of condensation or vapour at a low temperature to pass to the jacket of the thermostatic device d, which controls the inlet valve a to the radiator. Fig. 2 shows a heating-battery having a steam trap e, which is connected to the common return pipe c of the battery, arranged above the level of the base of the heating-apparatus. A by-pass k allows direct communication with the return main.

- 10,725. **Westwood, J. W.** May 8.

Heating water; heating buildings &c.—A boiler for heating water for warming buildings and for other purposes is composed of two portions, in one of which the circulating water is heated, and in the other water is heated to a high pressure and passed into a chamber, where it evolves steam which is employed to aid the circulation and increase the temperature in the mains. The high-pressure portion a of the boiler is constructed of rectangular chambers surrounding the grate c, and is supplied with water from the low-pressure part b by means of

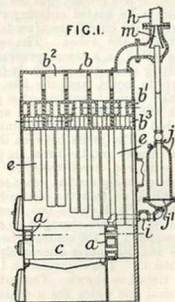

pipes fitted with non-return valves. The water from the return main enters the chamber b^1 , and, after passing through the circulating tubes e placed above the grate, passes through the chamber b^2 to the dome b^3 and thence to the rising main h . The high-pressure water in the portion a escapes through a leaded valve i and perforated plate j^1 to a low-pressure chamber j in which steam is evolved, and supplies the injector m for assisting the circulation and raising the temperature in the mains.

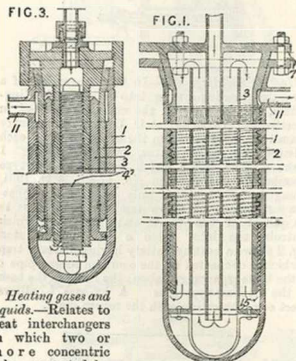
10,788. Sturm, H. May 8.

Heating gases and liquids.—Relates to heat interchangers in which two or more concentric tubes separated by a helical coil project into the heating-chamber, the fluid to be heated entering the central tube and leaving the outer tube after taking a helical course between the tubes. The apparatus, which is applicable as a steam generator or steam-superheating element particularly for use on war-ships, torpedo boats, and the like, or as a heater or cooler element, consists of a plurality of concentric tubes, some of which are plain and others ribbed to form helical annular passages for the liquid. The joints between the tubes are outside the furnace and the tubes are enclosed in a sheath. A solid rod, screw-threaded externally, may be inserted in the central space to which the liquid is supplied, so that the element becomes a metallic block. Fig. 1 shows one form in which four concentric tubes are arranged, so that the liquid which is supplied to the centre tube flows up and down the annular spaces alternately and escapes by the outlet 11. The outer sheath 1 and the tube 2 may be ribbed as shown. The tube 2 has an enlarged conical end which fits a conical seat at the upper end of the outer tube. The outer sheath 1 and the tube 2 are drawn together by bolts passing through flanges 7, or by a nut. The tube 3 is provided with a ring 15 at its lower end. In the

modification shown in Fig. 3, all the tubes are helically grooved, and an externally grooved rod 4^1 is inserted in the central space. The rod is provided with a pin at the lower end to prevent it from rising. In a further modification, the rod 4^1 has an extension upwards through which a central passage affords an inlet for the fluid.

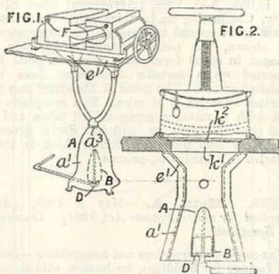
10,820. Arkless, W. E. May 9.

Heating-apparatus for vulcanizers. The heat generator A comprises a conical outer casing a^1 . Figs. 1 and 2, having an open bottom to allow access of air, and a smaller fireclay cone B, which is heated by the burner D, and warms the air between the two cones. The warm air passes by an outlet a^2 to the moulds or vulcanizers through flexible or fixed conduits. Openings F are provided in the moulds through which the hot air is allowed to escape when the temperature is sufficiently high. In one form of apparatus, shown in Fig. 2, an inverted cone e^1 is used as a connexion between the generator and the table on which the vulcanizer is placed, an opening k^1 being provided in the table over which is a grating K.

10,838. Reid, McFarlane, & Co., and Illemann, R. May 9.

Non-conducting coverings and compositions.—Non-conducting coverings for boilers, pipes, flange-boxes, and the like are formed by mixing equal quantities of asbestos and infusorial earth, or magnesia and asbestos, or fossil meal, cocoa-nut fibre and jute, and adding as a binder a solution of magnesium chloride mixed with magnesite to bring the whole into the liquid state. The mixture is then cast in moulds, and when set the casts are stacked to dry.

10,847. Fitzpatrick, H. D., [Salzman, J.]
May 9.

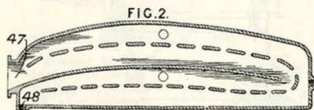
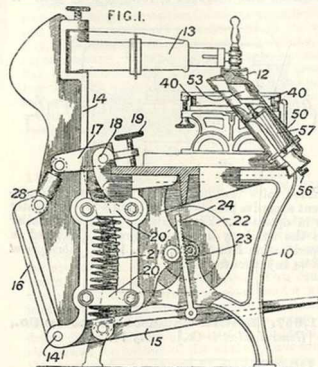

Heating by water circulation.—In a treadle clothes press, the pressure buck 40, Fig. 1, and heating-apparatus 50 are mounted on a fixed frame 10. A gas burner 56 supplies heat round a drum 47, seen in cross-section in Fig. 7, and arranged inside a lower chamber in the casing 50. The top of the drum communicates through an upper chamber 53 in the casing with the buck. The whole of the heating-apparatus is filled with water which circulates by convection through the buck, the construction of which is shown in cross-section in Fig. 2, the water entering at the end 47 and returning through the end 48 to the bottom of drum 57.



10,978. Adams, J. J. R. May 10.

Heating buildings; heating water.—Relates to arrangements for heating rooms, halls, warehouses, &c. wherein an open fire-grate, the back or sides of which are water boilers, is employed. The water circulates through hot-water pipes, radiators, or the like connected to the boiler. At the back and

sides of the boiler there is provided a chamber for combustion products which is closed except for openings at the bottom to the grate and uptake flues. As shown in Figs. 1 and 3, the boiler A,

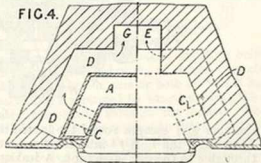
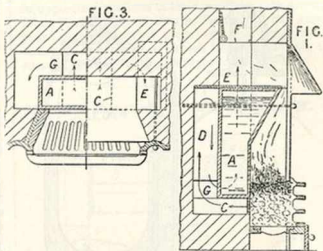

which is in communication with hot-water circulation pipes, radiators, &c., forms the back of the grate, leaving a passage C by which the products of combustion pass from the fire to the chamber D. The chamber D, which is charged with hot gases in a more or less stationary condition, has an outlet G at its lower end to side flues E which lead to the chimney F. Fig. 4 shows a modification in which the boiler forms the sides as well as the back of the fire-place. The chamber D also is formed at the sides and back of the boiler and has passages C leading to the grate and an outlet G to a flue E.

11,086. Spittler, W. May 11.

Non-conducting compositions.—A heat non-conducting composition consists of a mixture of coarse particles of wood or similar material with a binding-material such as magnesium chloride and oxide.

[Reference has been directed under Patents Act, 1902, to Specification No. 11,253, A.D. 1891.]

11,276. Auken, B. E. van. May 14.

Steam traps; heating buildings.—Condensed water from a steam-heating system is forced by means of the steam pressure up the conduit A'