

a boiler and a jacket 2, Fig. 3, riveted or otherwise secured to the wall of a cistern 1, from which the hot-water supply is taken. The jacket may be kept full of water by means of an

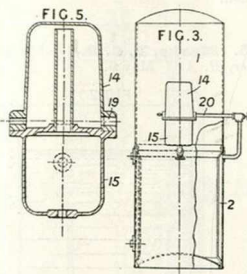

ordinary expansion tank or the device shown in Fig. 5 may be used for replacing any loss of water from the main supply. The lower part 15 is connected to the cistern 1 by means of the aperture at the bottom, and the upper part 14 communicates with the jacket through tubes 20 attached to the hole 19. A cushion of air is retained in the part 14.

9520. MacPhee, A. April 19.

FIG. 2.

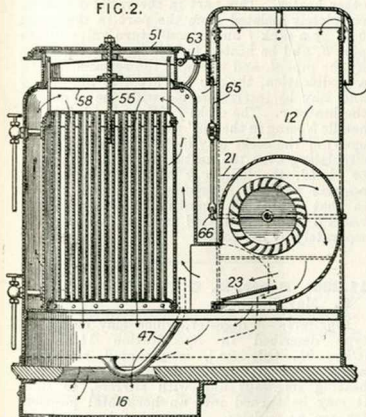

Heating air.—A heating, cooling and ventilating apparatus comprises a heater or cooler 1, a fan or blower 21, a damper 23 arranged to split the current of air from the fan so that part only passes through the heater 1, and an electric

motor actuating the damper and controlled by a thermostatic device in a chamber located in the apparatus and supplied with air by a tube 47. The cover 51 can be raised, this operation lowering by means of the screw 55 an inner disk 58 so as to cover the top of the heater 1, and at the same time, by means of links 63, 65, 66, operating a curved damper within the main air casing 12 to allow the eye of the fan to be in communication with the trunk 16. The apparatus then operates to exhaust the vitiated air from the building &c. ventilated.

9521. MacPhee, A. April 19.

FIG. 5.

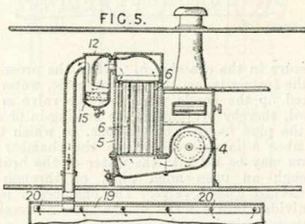

Heating air.—Air is drawn either from the outside or from the compartment ventilated by a fan 4 driven by an electromotor, and is passed through the tubes 6 of a temperature-changing device 5 and a water-separator 12 containing an absorbent 15, and is delivered to the compartment by means of nozzles 20 in a tube 19 extending along one side near the ceiling, a similar tube with nozzles being on the other side for the abstraction of air. The temperature of the air is regulated by pumping more or less cooling or heating medium through the device 5, the operation of the pump being controlled by a thermostat in the compartment. The pump is driven intermittently by means of a magnetic clutch and gearing connected to the shaft of the fan motor. Suitable baffles and trunks are provided to effect the circulation, abstraction, or supply of air to the compartments as desired.

10,311. Morison, D. B. April 27.

Feed-water, heating; heating water.—The surplus steam that normally escapes from a steam regenerative accumulator to the atmosphere is caused to pass into a body of water, conveniently feed-water, and to heat the same by its condensation. Exhaust steam passes by a pipe *b* to the submerged nozzles *d* in the accumulator *c*, and thence to the low-pressure turbine by a pipe *e*. When the pressure has risen sufficiently, steam passes into the feed-heater *h* by the nozzles *k* which are submerged to a greater depth than the nozzles *d*. A pipe *o*, perforated at the water-level *o'*, connects

the chambers *c* and *h*, and is provided with a non-return valve *p* at its lower end. Any uncondensed steam escapes by a pipe *l*, which may have a loaded valve *l'* to determine the

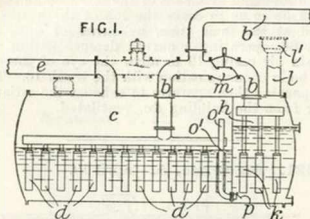

pressure in the chamber *h*. When the pressure in the system is less than atmospheric, water is forced up the nozzle pipes and the valve *m* is closed, thereby preventing the leaking-in of air by the pipe *l*. In modifications, in which the chamber *h* is separated from the chamber *c*, steam may be led into the water of the heater through an open-ended pipe, or through a submerged loaded valve. The chamber *h* may be divided into a series of chambers to receive steam successively as the pressure increases.

10,975. Wearing, G. B. May 3.

Kitchen - range and like boilers.

—Two boilers *b* with a connecting pipe *d* and a flue between them form the back of an open fire-place. The boilers may be one behind the other, or one above the other, the upper one projecting forwards or rearwards, and the lower boiler having the inlet and the upper one the outlet.

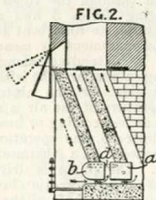

11,043. Agar, Cross, & Co., [Gee, T. J.]. May 4.

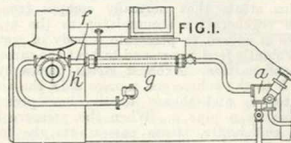

Feed-water, heating.—In a locomotive-type boiler having a tubulous water-heater arranged

transversely in the smoke-box, the feed is heated preliminary in the tube *f* leading from the pump *a* by means of exhaust steam in the jacket *g*. A gland *h* is provided to allow for expansion.

11,245. Marks, E. C. R., [Roberts, J., and Stoker, R. A.]. May 6.

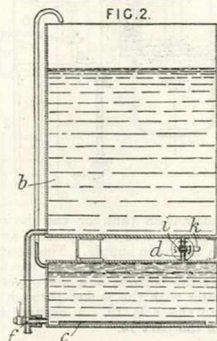

Heating water.—Water to be heated is divided into two parts, one part, preferably the smaller, being heated directly by an electric or other heater. This part in the vessel *a* may be completely isolated from the part in the vessel *b* as by a cock *f* and a non-return valve in the pipe *d*, and be heated to boiling, steam passing by the pipe *d*, and warming the remainder. In a modification, the tap *i* is fitted to the pipe *d* and may be interconnected with the switch of the heater *c*. The cocks *f*, *i* may be closed, the handle *b* being in the 'off' position and the switch open; or the cocks may be both open, the water circulating over the heater; or both cocks may be closed, the handle *k* being in the boiling position and the interconnected switch closed, so that the small quantity of water in the vessel *a* is quickly heated and may be drawn off separately by the cock *f*.

11,288. Scott, E. G., and Scott & Co., E. May 6.

Digesters.—A digester, which may be of the type described in Specification 11,155/01, [Class 91, Oils &c.], is mounted on trunnions, and is provided with means for heating its walls and with stirrers, so that it may be turned into an horizontal position for use as a drier. A vessel *a* has a steam jacket *p* supplied by a pipe *q*, which branches off from the pipe *i* supplying steam from the trunnion *f* to the interior of the vessel. A pipe *m* leads steam and vapours from the vessel to the exhaust trunnion *f'*. When the digesting is finished, the vessel is turned into an horizontal

position by a hand-wheel *u* and worm *f*, and the material is distributed over the heated walls by stirrers *e* on a shaft *d* and thus dried. A steam

an upward flow of water is induced through the passages *e*. The water may be deflected laterally

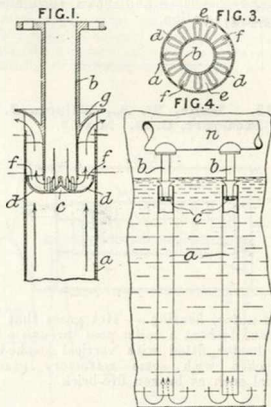
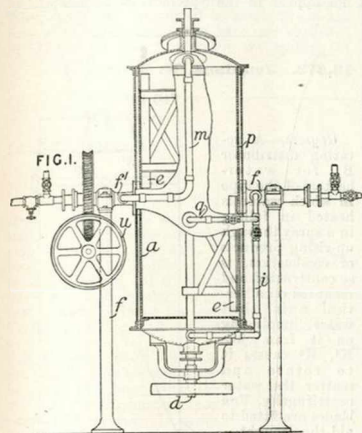

by the flange *g*. Specification 20,711/08 is referred to.

11,770. Pollard, E. May 12.

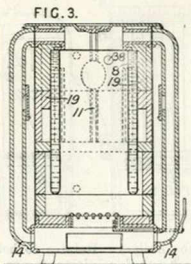
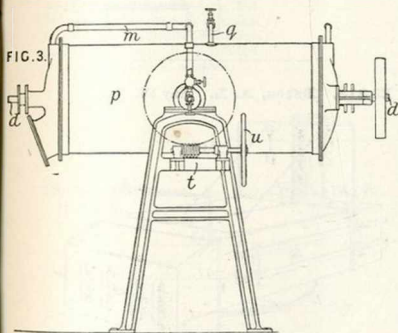

coil may be arranged between the stirrers and the wall of the vessel *a* instead of using a jacket.

Vertical boilers. — Relates to boilers of the type having an annular double-walled water-holding vessel 8 adapted to be heated both externally and internally by the products of combustion, which pass downwards from the central fire space 11, under the lower edge of the annular water space, and up between the external wall thereof and the casing, baffles 19 causing them to take a sinuous path. A chamber above the fire-space communicates by means of downwardly-extending external flues 14 with a chamber below the fire-grate in accordance with the provisions of the Specification 15,969/08, [Class 126, Stoves &c.], to cause unburnt gases from the top of the fire to pass through the fuel

11,690. Morison, D. E. May 11.

Heating water.—Exhaust steam from a main *n* passes by pipes *b* to nozzles *c* in the circulating-tubes *a*. As shown in Figs. 1 and 3, the nozzles *c* consist of radial hollow arms *d* projecting from the pipes *b* and formed with intermediate passages *e* for the water. As the steam discharges through the outlets *f* of the arms *d*,

on the grate. An aperture 38 is provided controlled by a damper to allow an upward draught at starting the fire. Modified forms of baffles and casings are described and shown, some adapted for steam-generation.

11,865. **Bone, W. A., Wilson, J. W.,** and **McCourt, C. D.** May 13.

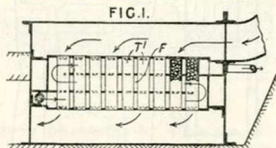

Feed-water, heating.—Hot gases that have been used to heat a boiler pass through a feed-water heater fitted with vertical smoke-tubes T^1 packed with some refractory granular material such as broken fire-brick.

12,217. **Barlach, H.** May 18, 1909, [Convention date].

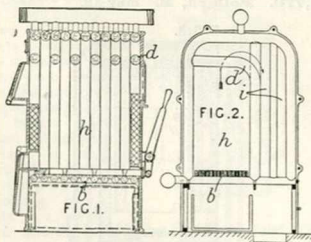

Water-tube boilers.—Relates to boilers of the kind in which tubulous elements are placed side by side, thus forming the outside of the boiler, and the walls of the fuel-chamber and the flues. Wrought-iron elements, Figs. 1 and 2, are placed side by side to form a fuel chamber h , a grate b , and flues i , to which the furnace gases are admitted through openings formed by bending, in alternate elements, the upper part of the tubes d at the back of the fuel-chamber. Vertical flues may be provided on both sides of the fuel chamber. Modifications are described wherein the openings to the flues are formed by constricting and flattening the tubes.

The Specification in the original form, as open to inspection under Section 91 (3) (a), states also

that the tubes of the elements may be of polygonal cross-section, and may be provided with ribs having a depth of from $2\frac{1}{2}$ to 3 times the diameter of a tube. This subject-matter does not appear in the Specification as accepted.

12,673. **Jennings, W. C.** June 17.

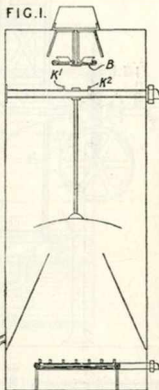

Geysers.—A rotating distributor B , for water-heaters of the type in which water is heated in falling in a spray through up-rising products of combustion, is so constructed and mounted on a vertical axis that water impinging on it from jets K^1, K^2 causes it to rotate and scatter the water centrifugally. Fan blades are fitted to aid the draught.

12,813. **Estes, A. L.** May 26.

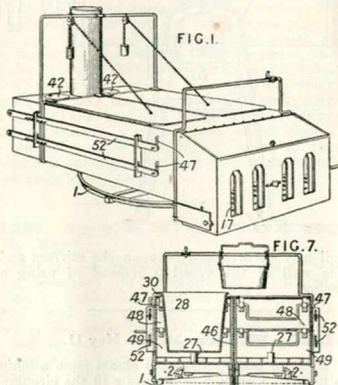

Washing-boilers.—A stove for heating pans 28, Fig. 7, for boiling clothes or heating water has a fire-box at one end of a casing and a

smoke-box at the other, the casing being divided longitudinally by a partition 46. Access of the flames to the compartments can be controlled by superposed dampers 48, 49 in each, operated by cranks 47 and rods 52 outside the casing. The pans 28 are supported by studs 27 on the bottom of the casing, and have an extended lip 30 on one side to prevent the spilling of

liquid on the top of the casing. Plates 42, Fig. 1, on the top of the smoke-box casing may be removed for the insertion of cooking-pots. The grate 17 is arranged to tilt upon its front edge. The casing is mounted on wheels 2 adapted to run on a circular track 1, so that the furnace may be in a favourable position for draught when in the open air.

12,872. Simister, S. May 27. [Addition to 10,233/09.]

Washing-boilers. — The cross-piece *a*, which supports the burner is made detachable by having the ends *a* bent to engage staples *c* or openings *f* in the side walls *A*. The annular member *a*² which centres the gas burner is further made to act as a collector *a*³ for condensation products which form on the pan *d*. The collector may be made separate from the member *a*² and mounted upon another cross-piece. In order to direct the condensation matter to the collector, the bottom of the pan *d* is made tapering with slightly rounded point, and may be provided with a corrugated surface.

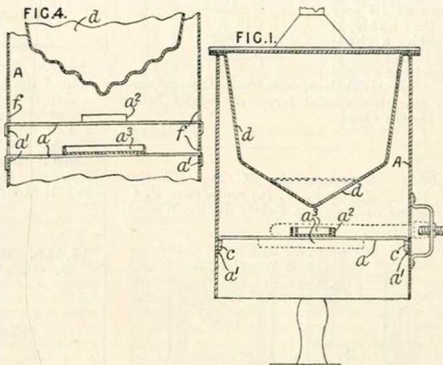

12,980. Collinge, J., and Creak, T. M.
May 28.

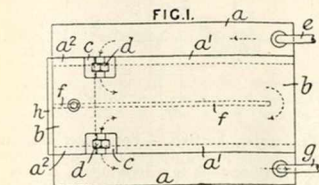

Kitchen-range boilers. — A kitchen-range boiler which can be quickly taken out and replaced comprises two stout hollow cheeks *a* formed with ledges *a*¹ supporting the upper part of the boiler *b*.

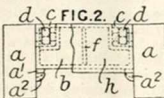

Two recesses *c* are formed near the front end of the part *b*, and in these, unions *d* are fitted coupling up the boiler and the side cheeks. Water enters by a pipe *e* and passes through one of the side cheeks and through the first union *d* into the portion *b*. A partition *f* compels the water to pass to the back of the boiler, and thence to the second union *d*, whence it passes to the pipe *g* by way of the other cheek *a*. A detachable L-shaped plate *h*, resting on ledges *a*² protects the front of the boiler. The hollow portion of the cheeks *a* need only extend down to the level of the bottom of the portion *b*. In a modification, the cheeks may be solid, and water may be supplied to the front of the portion *b* by separate conduits extending from the back of the boiler and parallel to the cheeks; or the pipes *e*, *g* may rest in grooves formed in the cheeks.

13,053. Smith, W. W. Nov. 30.

Heating water.

—Comprises a system for enabling a copper for boiling clothes to be used for supplying hot water to baths &c. on an upper floor, the hot water being raised by the pressure of a column of cold water in a pipe D. The hot water passes on its way to the bath B through a hot-closet heater J comprising a number of tubular shelves, rails, &c. The invention also comprises special forms of tightly fitting lids for the copper.

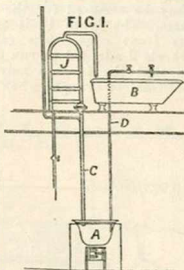

13,551. Fitzpatrick, H. D., [Wharton, J. S. L., Hallowell, W. S., and Jones, J. O., (trading as Harrison Safety Boiler Works)]. June 4.

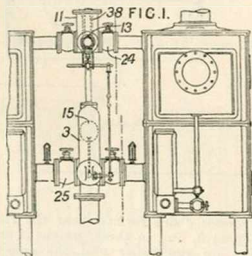

Feed-water heating; water supply.—The variation in the height of water or other liquid in a battery of heating-units is used for controlling automatically the supply to all the units. In order to ensure that each feed-heater, for example, of a number, is supplied with the same amount of water, the valve 13, actuated by a float 15 in a chamber 3 communicating with all the units, controls the supply in the first instance to a chamber 11 in which are diaphragms 38 of equal height, forming compartments, each of which leads to a heater. By means of suitable valves 24, 25 any heater may be cut out for repairs.

13,558. Wilson, H. F. June 4.

Vertical boilers; geysers.—Water to be heated passes in the space between an outer casing D

and an inner casing made in sections A, B, B^x. Combustion products generated in the base A, on passing through the neck A¹, are directed by a baffle, to pass circumferentially in the

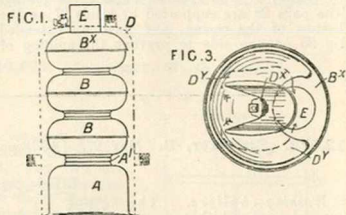

chamber B before passing through a passage behind the baffle to the adjacent section, where a similar baffle is situated. In the uppermost chamber B^x, a baffle D^x, seen from below in Fig. 3, directs the flue gases in two paths to the uptake E. The baffle D^x is supported by a plate D^y attached to the upper part of the section B^x of the inner casing. Specification 589/04 is referred to.

14,545. Bruce, W. J. W., and Downie, T. June 16.

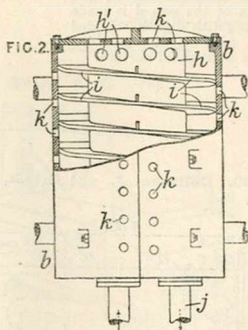

Feed-water, heating.—Feed-water from the condenser is passed through an air-separator and a settling-tank to a feed-pump. Thence it is forced into a heater *b* situated within the steam-generator. Feed-water from other sources is forced into the heater by an auxiliary pump. The heater comprises a central chamber *h* and a helical channel *i*. The water passes into the central chamber, overflows through holes *h'*, and, in passing down the channel *i*, is heated by steam which enters through holes *k* in the casing. The heated water passes into the generator by a pipe *j*.

16,080. Low, A. July 6.

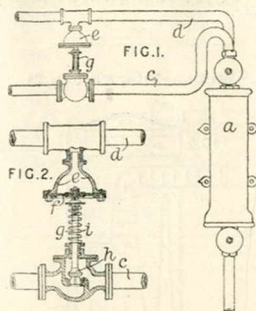

Heating water.—In a calorifier in which the water is heated by means of steam coils, a pressure-responsive device is fitted on the hot-water discharge pipe, and is connected to the steam-inlet valve so as to cut off the steam supply when no hot water is being drawn off. In the construction shown in Figs. 1 and 2, a chamber *e* is fitted on the discharge pipe *d* of the calorifier *a*. The chamber *e* is closed at the bottom by a diaphragm *f* connected by a spindle *g* to the steam valve *h* in the pipe *c*. When the discharge of water from the pipe *d* is interrupted or stopped, the pressure in the chamber *e* increases and forces down the diaphragm *f* and spindle *g*, and closes the valve *h*. A spring *i* assists the valve *h* to open. A modification is described in which a cylinder and piston are used instead of a diaphragm.

16,461. Norris, W. July 9.

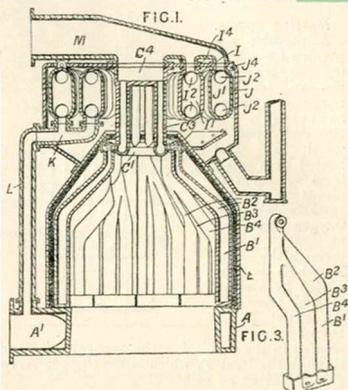

Water-tube boilers.—An annular casing *A* is connected to a tubular ring *C* by a series of tubulous castings *B*, one of which is shown separately in Fig. 3, comprising three water legs *B*², *B*³, *B*⁴ tapering to the top and bent inwards, the whole forming the fire-box of the boiler. Tubes *C* connect the ring *C* with a section *C*⁴. Two water-holding rings *I*, *J* are ranged above the fire-box in the casing *E*, each constructed of a series of vertical sections *I*¹, *J*¹, respectively, communicating by apertures *I*², *J*². The rings are connected to the upper chamber *M* by hollow bosses *I*⁴, *J*⁴, and to the return pipe *A*¹ by a pipe *L* and header *K*.

16,633. Jeffreys, J., Herring, E., and Grenville, P. M. B. July 12.

Heating water in bulk by steam-pipes. Water is heated in a container *a* by means of steam admitted to the space between two cylinders *g* projecting therein. Ribs *m* on each side of the annular space cause the steam to pass along the top half before escaping from the lower part by the outlet *o*. Thimbles *k* allow the water to circulate over the heater. Inlet and outlet connexions *d*, *c* are provided for the water.

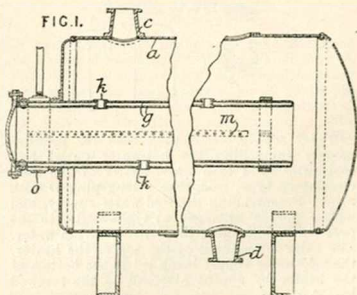

17,132. Cooper, Son, & Co., and Cooper, A. J. B. July 19.

Heating gases.
—A portable apparatus for warming oxygen for use in inhaling comprises a water-container A mounted upon a stand R and heated by a spirit lamp or the like placed on the adjustable table M. Oxygen entering at C passes through the spiral B, which is supported by a strap E, and thence to the outlet D. A thermometer J is secured in the socket I. The apparatus is filled through the inlet F, which is closed by a screw plug G having an orifice H.

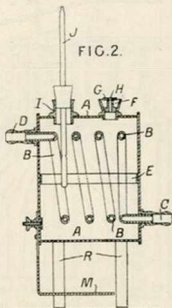

17,183. McGerry, M. D. July 19. *Drawings to Specification.*

Heating air.—In an electric car heating and ventilating system in which two fans are employed, the one for delivering fresh air to the car, the other for discharging foul air, the fresh-air may be heated by being drawn by the fan through the chamber surrounding the rheostat controlling the car motor. The air thus

17,518. McLoughlin, F. July 23.

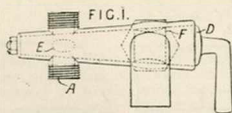

Water supply.—A plug cock for simultaneously controlling the hot-water outlet and cold-water inlet to a water-heater of the non-circulatory type, comprises a long plug D with a port E controlling the cold-water supply, and with a port F arranged at right-angles to the port E for controlling the delivery of hot water. The valve is mounted at the top of the heater, the cold-water supply being led to the bottom of the heater by a pipe attached to the screwed boss A.

heated may be delivered to the car through an auxiliary chamber containing an electric heater of a known type controlled from a suitable point on the car.

17,516. McLoughlin, F. July 23.

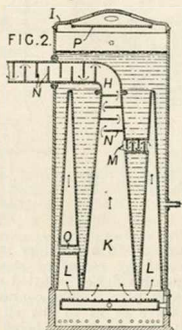

Geysers.—A water-heater is provided with a central conical flue K communicating with a transverse flue H, baffle-plates N being fitted as shown. A surrounding annular flue L provided with water-tubes Q communicates with the central flue by one or more passages M fitted with baffle-plates. The loose cover I carries a condensation plate P.

17,560. Bone, W. A., Wilson, J. W., and McCourt, C. D. July 25. *Drawings to Specification.*

Feed-water, heating.—The feed is heated by contact with tubes packed with granular refractory material through which the waste gases from the boiler are passed.

17,611. Costa, J. R. da. July 25. *Drawings to Specification.*

Feed-water, heating.—The feed-water of a steam-generator is heated in an enlarged part of the feed-pipe passing across the uptake.

17,922. Yates, H. J. July 28.

Vertical boilers.—In a water-heater consisting of a hemispherical, cylindrical, or other shaped shell a having a concave or hollow underside provided with an annular baffle f, the shell

is formed with a part *e* projecting downwards inside the baffle. The heating-surface of the

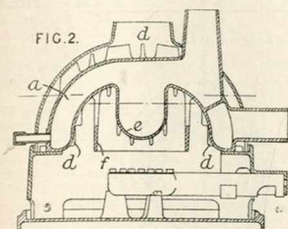

boiler may be further increased by forming the shell with projections *d*.

18,035. Bell, A.
July 29.

Kitchen-range and like boilers.—An angular boiler with an horizontal or slightly inclined branch 5 and a rearwardly and downwardly inclined branch 4 is fitted in a domestic fire-place. A flue 7 is formed beneath the boiler, and one or more flues 10 may be formed through the branch 5.

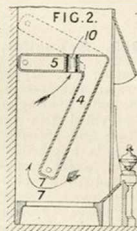

18,154. Midgley, C. July 30.

Vertical boilers.—Apparatus for boiling water comprises an internal flue built up of a series of drums *a* having pairs of holes *j* at top and bottom connected by collars *g*, the holes being arranged in different vertical planes to ensure a sinuous course for the heating-medium in its upward passage. A shallow tray is fitted to the top drum to receive any sediment that may be deposited, and there is also provided an auxiliary receptacle *c*, through which the water is automatically circulated, suspended matter being trapped therein.

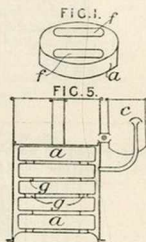

used as a feedwater-heater or a superheater; also steam can be blown through it backwards for cleansing. The tubes *g*, Fig. 1, are attached

18,211. Garrett, R., and McPhail & Simpson. Aug. 2.

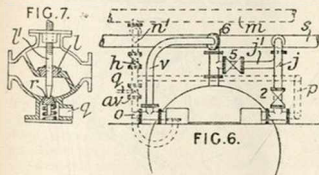

Feed-water, heating.—Apparatus consisting of U-shaped or like tubes placed in the downtake at the back of a Lancashire or like boiler is provided with connexions whereby it can be

to inlet and outlet headers *ih* and *oh* carried on a plate *d* covering the downtake chamber *c*. The plate *d* is made in halves, secured together by slot-and-bolt connexions *e*, so as to be adjustable according to the size of the chamber *c*. The halves of the plate *d* may overlap, or the junction can be covered by a plate *d'*. The dotted lines in Fig. 6 show the connexions by which the apparatus is adapted for use as a feedwater heater. From the water-pipe *m*, a pipe *n'* leads to the boiler. A stop-cock *h* is placed in the pipe *n'*, and from above the cock *h*, a pipe *o* leads to the inlet header *ih* and a pipe *p* from the outlet header *oh* enters the pipe *n'* below the cock *h*. Below the junction of the pipe *p* with the pipe *n'* is a valve *av*, so constructed that it directs the heated water either to the boiler or to a pipe *q* leading to the feedwater tank. The construction of the valve *av* is shown in Fig. 7. The course of the pipe *n'* is controlled by a plug-valve *l* on a screwed

stem l^u . The end of the stem l^u presses on a spring-controlled valve r , controlling the pas-

sage to the pipe q , so that, when the valve l is closed, the valve r is opened and conversely.

18,262. Schaeffer, A., [Firm of]. Aug. 2, 1909, [Convention date].

Heating air.—Apparatus for the production of heated compressed air comprises a motor, a fan, and a heating-device arranged in a casing and provided with means for varying the temperature and pressure of the current. The invention is applicable to hot-air douches. A motor b , a fan c , and a heating-device e are supported in a spherical casing a , which is itself suspended from a tube by a ball k , a safety sleeve l^2 being provided. The air is drawn by the fan through perforations h in the casing, and divides into two currents, the one passing into the fan by way of the heating-device, the other by way of the motor, which it cools in passing. By varying the position of a slide m by a hand-wheel n , Fig. 8, the distribution of the incoming air between the heater and the motor may be regulated and the temperature thereby controlled. The heated air is delivered through a pipe f , a flexible pipe union-piece r fitted with a filter y , Fig. 9, and a mouthpiece s , which contains two rings u , v of different bores adapted to be rotated relatively to one another to regulate the area of the outlet and consequently the pressure of the discharged air. The motor switch is controlled by a handle 9 .

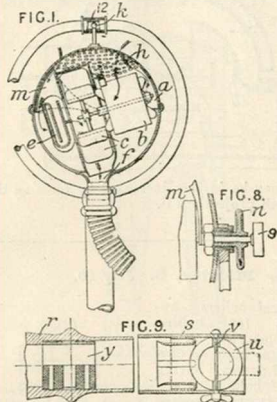

18,754. O'Brien, Thomas, & Co., and Salter, W. J. S. Aug. 9.

Kitchen-range and like boilers.—A boiler is fitted within an anthracite stove above the level of the burning fuel, and with a space between it, or between a heat-retaining material against which it is placed, and the walls of the stove. The usual lining may be replaced at the back and sides of the stove by the boiler A , which may have openings a^2 through it permitting the gases to pass to the surrounding space a^1 .

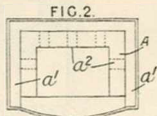

being placed on each side of a rotating drum, and the turrets being connected together.

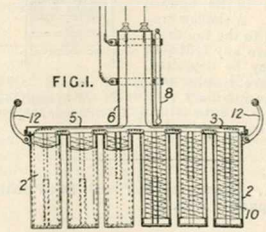

19,100. Lofquist, H. Aug. 13.

Submersible heaters.—A submersible water-heater heated electrically consists of a number of tubes 2 which contain resistances, and are closed at one end and open at the other end into a common chamber, the cover 5 having a turret 6 for the leads. The heater may be held down in a bath by a wire frame having side members f , Fig. 3, hooked on to the bath, these members being either flexible, or having rubber connexions g with the wire frame. Two heaters may be used in a washing-machine, one

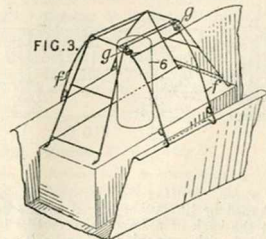

19,281. **Hyland, J. H.**
Aug. 17. *No Patent granted*
(Sealing fee not paid).

Heating water; vertical boilers.
—A single fire upon a grate B is arranged to heat water in the surrounding boiler C and the covering-boiler G, and also, by means of a flue F, the water in the tank J, to which they are both connected. Hot water is distributed as required from the service pipe R.

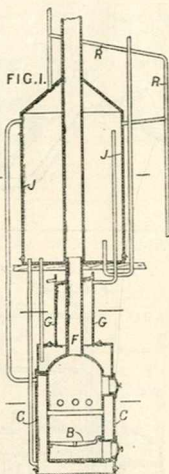

20,164. **Iliff, F.** Aug. 30.

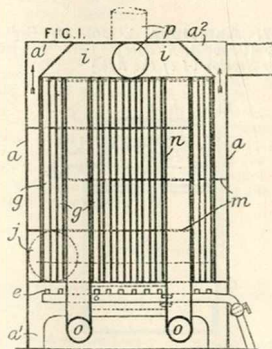

Heating air.—Relates to apparatus for heating air and delivering it to a room and for extracting foul air from the room near the floor level and discharging it outside. Steam or other means may be employed for heating the air, but the Specification describes the apparatus as adapted for heating by burners. As shown in Fig. 1, fresh air enters the casing through a dampered pipe *j* and, after circulating around baffles *m* and over the pipes *g*, enters the room through openings *a*². Pipes *n*, having

open lower ends controlled by hinged doors at *o*, convey foul air to the chamber *i*. In a modified apparatus, the outer casing, which may be a hollow pillar, is circular, and the baffle *m* is helical.

20,307. **Mackay, R.** Aug. 31. [Addition to 18,919/09.]

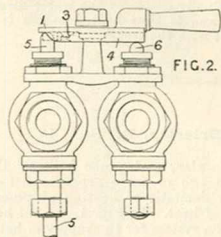

Water supply.—Apparatus as claimed in the parent Specification, in which water is boiled by turning on the heating-medium, and is caused to flow through an outlet by the pressure of steam generated, is improved by providing mechanism for simultaneously shutting-off the cold-water supply to the feed-tank when the heating-medium is turned on. The valves are arranged so that a cam 4 on a plate 1 depresses two spring-pressed valve spindles 5, 6, one of which controls the heating-medium, and the other the cold water. A cam 3 of less depth is also fitted to the plate so that, by further rotating the plate, the cold-water supply can be partly opened while the heating-medium is still full on.

20,442. **Warner, W. J., and Lichty, D. A.** Sept. 1.

Heating water.—Steam or hot water is admitted by a tube 29, perforated at the top, to mix with cold water entering by a passage 7 and annular chambers 24, 31. Hot water thus produced is led away by a port in the base 6, communicating with the lower end of the annulus 31. A screwed piston 32 regulates the quantity of steam &c., and hence the temperature of the resulting hot water.

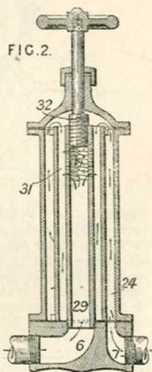

20,832. **Tranter, W. J.** Sept. 7.

Feed-water, heating.—In apparatus of the type arranged in the steam space and comprising a series of basins into which the water successively overflows, water from a pipe 5 flows up a central inlet 6 and impinges against the inner surface 7^a of a chamber 7, of which the outer edge 8 reaches nearly to the bottom of the upper basin 4. The water flowing under the edge 8 gradually displaces the water already in the basin, and is thus heated before it comes into contact with the steam.

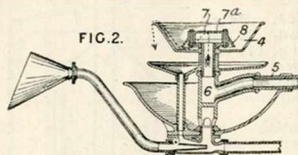

21,448. **Brierley, R.** Sept. 15.

Heating water; water-tube boilers.—Heat is supplied to two or more separate hot-water services for domestic or heating purposes from one source of heat. In Fig. 1, several heating-systems and a system for the supply of hot water are heated by passing a portion of the piping of each system through a single kitchen-range fire. The heated parts may be of copper.

Reference has been directed by the Comptroller to Specification 68/77.

FIG. 1.

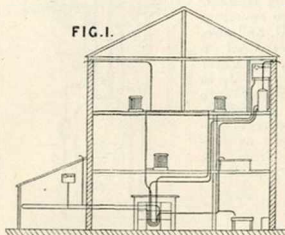

21,467. **Rhea, L. C.** Nov. 19, 1909, [Convention date].

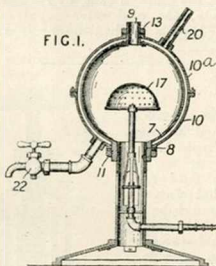

Geysers.—A water-heater comprises two spheres of thin metal arranged concentrically to form a thin water space between. The outer is made in two parts 10, 10^a, and the inner sphere 7 may be similarly divided to allow the fitting of the burner 17. Nuts 11, 13 on screwed bosses 8, 9 keep the segments in position. Water enters at 20, and is delivered from the cock 22.

21,697. **Ahlgimm & Co., U.** Sept. 18, 1909, [Convention date]. Void. [Published under Section 91 of the Act.]

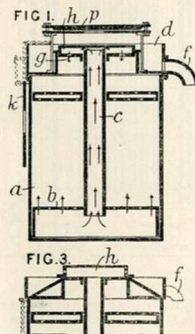

Washing-boilers.—Means are described for discharging the liquid in washing-boilers of the type having a central circulating-pipe *c* up which the liquid is forced by the generation of steam in the chamber below the perforated plate *b*.

During normal working the circulating liquid returns through apertures *g*, Fig. 1, in the hollow cap *h*. If this cap be replaced by the plate *k*, the liquid then flows to the chamber *d* and escapes by the pipe *f*. Fig. 3 shows a modification, the operation being the same. Two other forms of discharge caps are described, one of which also permits a certain quantity of liquid to return to the vessel *a* to prevent it from boiling dry.

21,747. Muchka, J. Sept. 19. [Addition to 28,071/09.]

Heating liquids.—In the system described in the parent Specification, in which exhaust steam is collected in a chamber and passes thence through a loaded valve into the suction pipe of a pump to condense the steam and heat the water, a by-pass to the atmosphere is arranged so that the steam first forces out the air in the exhaust pipe and the connected passages before passing to the suction pipe. Exhaust steam forces air from the collecting-chamber &c. to the inlet 3, and thence through the passages 16, 15 formed in the stem 7 of the valve 6 to the space below the piston 8, the air finally escaping round the edges of the latter to the outlet 4. When all the air is driven out, the pressure rises and the consequent movement of the piston 8 closes the passage 16, and, by withdrawing the valve 6, allows steam to pass through the nozzle 5 into the section pipe 1, 2. In a modification, the valve 6 and the piston 8 are formed in one piece.

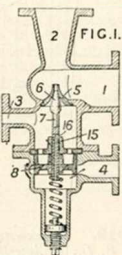

22,136. Rhea, L. C. Aug. 2. [Convention date]. [Addition to 21,467/10.]

Geysers.—A water-heater or steam-generator is constructed of two concentric substantially-spherical casings, the inner wall being thinner than the outer, with a water space between. A burner 22 is fitted within the lower portion 6 of the inner casing, comprising a deflector 26 having a lower side of substantially the same curvature as the inner casing, so as to produce spherical flame. In the form shown, the upper part 38 of the inner casing is bent so as to form a water-holding pocket 39; but this pocket may be omitted.

(For Figure see next column.)

22,136.

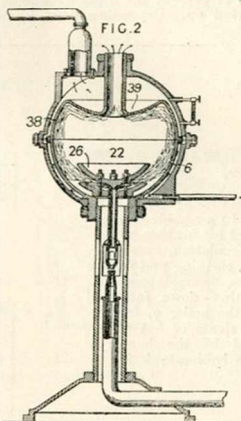

22,332. Jackson, H., and Jackson Boilers, Ltd. Sept. 27. [Addition to 16,804/07.]

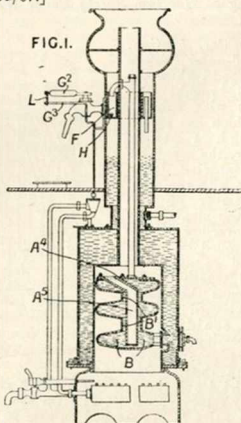

Vertical boilers.—The water-heating part of the boiler described in the parent Specification is made with bulbous parts B connected by cylindrical necks B'. A removable plate A' is provided bearing a hollow or other core A'. In the expansion tank F, into which the boiling

water is delivered, is a vane rotated by the flow of water, to prevent the draining-hole H from being furred up. Depending links L, capable

of movement one way only, serve to operate the gas-valve handle G² at the same time as the water-handle G¹, to prevent waste of gas.

22,547. Hill, J. W.
Sept. 29.

Kitchen-range and like boilers.—In a combined apparatus used for heating by hot-water circulation, melting lead &c., cleaning and drying armatures, commutators, &c., and melting-down fats and greases, the boiler *q*, for circulating steam or hot water, is heated by the burner *r* below the boiling-tank *j*.

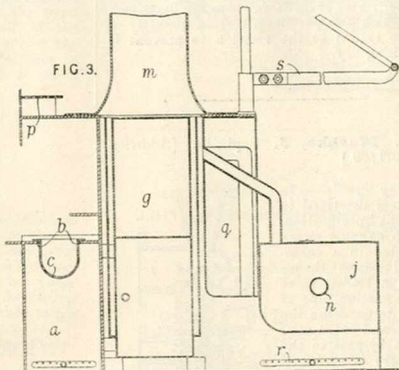

22,918. Alexander, A. E., [Wharton, J. S. L., Hollowell, W. S., and Jones, J. C., (trading as Harrison Safety Boiler Works)].
Oct. 4.

Feed-water, heating.

—In feed-water heaters of the type in which the water is brought into contact with exhaust steam which has passed through a steam separator, the separator being connected by a drip-pipe with the overflow chamber of the heater, the steam inlet and the overflow passage are controlled by valves connected so as to be operated together. By these means the heater can be cleaned without risk of scalding by steam passing through the drip-pipe and overflow chamber. The steam inlet 4 and the overflow outlet 5 are controlled by rotary valves 10, 11. On the spindle 19 of the valve 11 are secured an arm 20 and a handle 23. To the arm 20 is hinged a link 21, which is attached by a slotted connexion to an arm 17 on the spindle of the valve 10. In this way, when the valves are opened, the valve 11 is some way open before the valve 10 commences to move, so that the pressure on the two sides of the valve 10 are equalized and opening is facilitated.

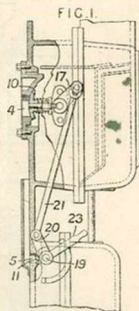

22,919. Alexander, A. E., [Wharton, J. S. L., Hollowell, W. S., and Jones, J. C., (trading as Harrison Safety Boiler Works)].
Oct. 4.

Feed-water, heating.

—In a device for heating feed-water by direct contact with waste steam, the steam being introduced through a separator, the drip from the separator passes to the overflow of the heater and a system of valves is provided whereby, when the waste steam inlet to the heater is closed, the separator is also cut off from the overflow chamber. The drip-pipe 8 from the separator 2 can be connected to either of the pipes 8^a, 8^b and cut off from the other by the disk-valve 11^c. The pipe 8^a passes to the overflow chamber 3, and the pipe 8^b directly to waste. The valve 11^c is connected by the linkage shown with a valve 10 closing the steam inlet 4 to the heater, so that, when

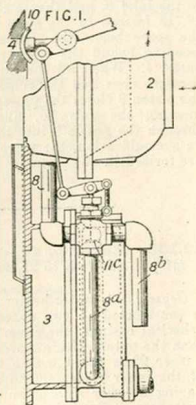

the inlet valve 4 is closed, the pipe 8 is cut off from the pipe 8^a and connected to the pipe 8^b.

The pipe 8^b may be bent to form a water-seal and connected to the chamber 3.

22,921. Alexander, A. E., [Wharton, J. S. L., Hallowell, W. S., and Jones, J. C., (trading as Harrison Safety Boiler Works)]. Oct. 4.

Feed-water, heating.—In apparatus for heating and re-using the water of condensation in a steam-engine, along with a supplementary supply of raw water, steam is brought into contact first with the raw water and then with the water of condensation, both being finely divided. The raw water is filtered before being allowed to mix with the water of condensation. The raw water is heated on trays 13, and the water of condensation on trays 14, arranged on opposite sides of a partition 10 with passages 15 for the steam. The raw water passes under the partition 10 and upwards, through a filter 2, then meeting the water of condensation. A bypass is provided, as shown, through which the raw water passes when the filter is clogged. One or more floats 12 in the outlet chamber operate

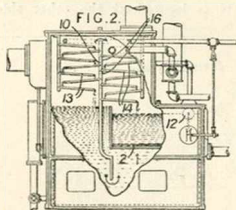

valves controlling the supply of raw water and of water of condensation, or of raw water only.

23,564. Hülsmeier, C. Oct. 11.

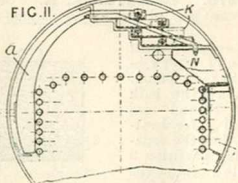
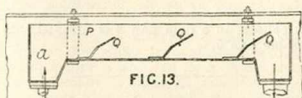
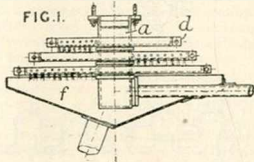

Feed-water, heating.—In purifying and heating feed-water for steam-generators by bringing it into direct contact with high-pressure steam, the steam is caused to act on the feed-water in such a manner that the feed-water is raised to at least 150° C. only at the place or places

where precipitation of impurities is to be effected. Many forms of apparatus for carrying out the invention are described, which are of the type comprising a large open receptacle, acting as a de-aerating space, and provided with spouts leading to trays through or over which the water passes successively. Fig. 1 shows an apparatus adapted to be placed inside a stationary boiler without restriction of space due to stay-bolts &c. The de-aerating chamber *a* is suspended from the boiler crown, and supports trays *d* of increasing size, subdivided by partitions into larger or smaller compartments which are perforated either at the sides or the bottom. The water flows in a zigzag path, entering the unperforated compartment of each tray *a* first, and descends with the mud into a conical chamber *f*, which may or may not be provided with a run-off pipe leading to the bottom of the boiler near the blow-off cock. A partition may be arranged adjacent the blow-off cock to form a mud-collector. A blow-off pipe may, however, be directly connected to the mud chamber. In a modification, the chamber *a* is provided with horizontally elongated spouts, and the sides of the trays are bevelled to give the zigzag path. In another modification, the chamber *a* is located at the end of a pyramidal system of long troughs or trays arranged alternately in longitudinal and transverse rows, the trays in adjacent rows in both directions being arranged in staggered relation. This apparatus may be arranged inside the generator or in a separate vessel. Where the internal space of the boiler is restricted by smoke-tubes, steam-collecting pipes, &c., the apparatus may be constructed as follows: (1) the chamber *a*, in the form of a long trough, is disposed at the uppermost portion of the boiler, and the water flows thence over corrugated sheeting along the

boiler shell, being admitted to the boiler water through openings near the bottom; (2) superposed rows of staggered trays are arranged between longitudinal chambers *a* mounted on transverse supports, the outer walls of the chambers conforming somewhat to the curve of the boiler shell; (3) as shown in Fig. 11, the chamber *a* is located at one side, the trays *K* are arranged in cascade formation, and the mud-collector *N* is located at the other side, and

supported on an angle-iron; (4) as shown in Fig. 13, the chamber *a* is integral with a long receptacle *P* provided with partitions *Q* perforated at their upper edges. Instead of subdividing a long receptacle, a number of smaller receptacles may be arranged in series, and such series may be further arranged in superposed rows.

Reference has been directed by the Comptroller to Specification 13,367/06.

24,102. Austin, E. Oct. 18.

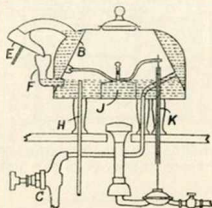

Portable and small water-heaters.—Water is supplied by a tap *C* to the outer compartments *B* of the heater and, on heating, drips thence through a spout gutter *E* and drip-cup *F* into the inner compartment, whence the overflow passes down a pipe *H*. By tilting the gutter *E*, the water may be led into any receptacle.

24,155. Curtis, I. F. C. Oct. 18.

Geysers and like instantaneous water-heaters.

—An instantaneous water-heater comprises essentially a particular form of hydrocarbon burner *13* and water-coil *15*. The burner comprises upper and lower members made up of concentric rings *10*, *8* of semicircular cross-section, connected by webs *11*, the outermost rings being provided with corresponding screw-threads. The upper rings overlap the lower ones, which are provided with notches *12* forming outlets for the gaseous fuel. The water-coil consists of a single tube bent to form upper and lower spirals, the convolutions of which are arranged so as to break joint; the water-inlet pipe *17* leads to an intermediate convolution of the lower spiral, and the outlet pipe from the outermost convolution of the upper spiral. The water-coil may be provided with a hood *34* for deflecting the heat from the burner. A pedestal *1*, which supports the burner and coil, also supports a casing *32* having a central outlet *31* for products of combustion, and containing storage tanks *20* communicating with the coil. An arrangement of valves and pipes is provided whereby water can be drawn off directly from the coil, directed into the tanks

from the coil, or drawn off from either the top or bottom portions of the tanks. Moisture

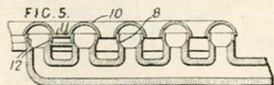
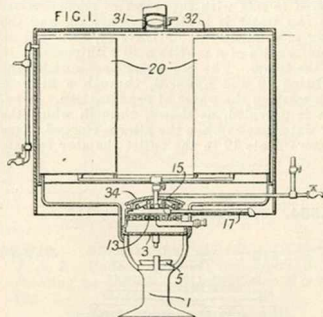

which collects in a drip pan *3* is drained into a removable pan *5*.

24,270. Casagrande, A. Oct. 19. *No Patent granted (Sealing fee not paid).*

Portable and small water-heaters.

—A pan *1*, containing both food *8* and material *7* for heating, has the separating partition *3* rolled into the outer casing. Openings *6* are provided for starting the heating action.

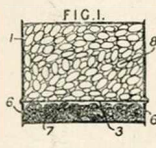

Reference has been directed by the Comptroller to Specification 12,763/04.

24,573. Nesbit, D. M. Oct. 22.

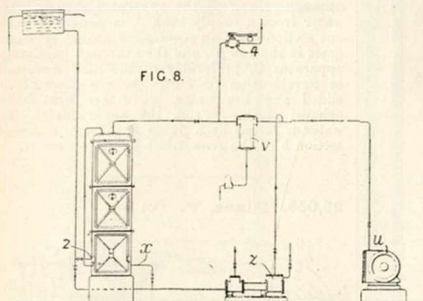

Heating water; feed-water, heating.—Apparatus for heating water by direct contact with steam, for heating - apparatus for buildings, boilers, cooking and washing apparatus &c. comprises a casing through which steam passes downwards through a pipe formed in sections through each of which steam passes by apertures *k*, Fig. 1, and each of which is formed with a perforated baffle-plate *m*. The lowest section is supported by an imperforate plate *l*, and a plate *d* is arranged above the top section having water-inlet holes which may be surrounded by raised bosses. Above this plate is a domed cover which may have water-inlet holes not registering with those in the plate *d*. Below the heater is a container with an arrangement of float-valve described in Specification 21,020/97. This valve may operate a valve in a pipe supplying any extra water to the heater. Doors *c*, in which inspection doors *s* are formed, are fixed on the casing, a jib *q* assisting in their removal. In one application, shown in Fig. 8, exhaust steam from an engine *u* is freed from grease in a separator *e* with a trap, and passes through the heater, hot water from which is withdrawn through a pipe *x* and fed by a pump *z* to one or more boilers. Make-up water is supplied from a tank through a valve 2 operated from

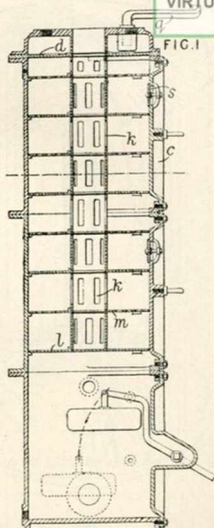

the float-valve. A back-pressure valve 4 is provided, and a circulating trap of the kind described in Specification 25,234/02 may be interposed in the system. As applied to a heating or warming system, steam from an engine is passed to a low-pressure drum, whence it passes partly to the radiators and partly to the heater; the steam and water from these pass to another drum and thence after straining to the heater, the water being pumped back to the boiler. In another application to cooking, washing, &c., a storage tank and circulator are used; in a system of heating large buildings, two circulators may be employed.

24,617. Tolhurst, B. W., and Stevens, C. R. Oct. 24.

Water-tube boilers.—A combined radiator and hot-water boiler comprises a tank *A* mounted above a series of large diameter tubes *M*, beneath each of which is a gas-jet *O*. Water-tubes *H* depend from the tank into each of the flue-tubes.

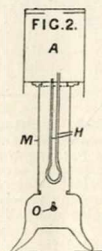

24,691. Redfern, C. G., [Bartle & Co.]. Oct. 24.

Washing-boilers.—The boiler or pan 1 has a dished bottom 2. Spaced out from this by lugs 6 is a conical plate 3 bearing a pipe 5. The clothes &c. rest on a perforated cone 8 supported on lugs 7, and boiling lye is forced by the pressure of steam generated on the application of heat from the stove 16, out of the top of the pipe 5, being directed by a removable deflecting-cap 9. To assist in spreading the lye over the clothes, the cap has a coned centre 11 and a turned-down rim 12.

(For Figure see next page.)

24,691.

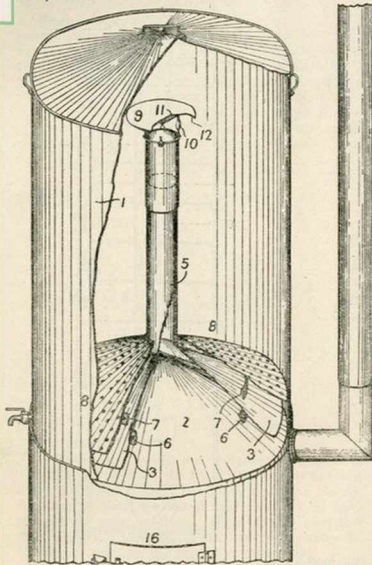

24,992. Erith, C. Oct. 27.

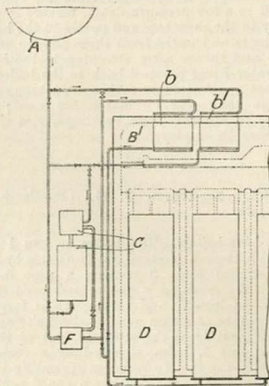

Feed-water, heating.—In heating and purifying water for industrial purposes, the water is

heated by waste gases both before and after purification treatment in a vessel vented to the atmosphere. With the apparatus shown, feed-water from a supply tank A is passed through one section b^1 of an economizer heated by waste gases in the flue B^1 , and then through purifying-apparatus C, preferably of the kind described in Specification 6946/04, where a chemical is added and the water is further heated by exhaust steam. From the apparatus C, the water is forced by a pump F through a second section b of the economizer to the boilers D.

25,059. Binns, V. Oct. 28.

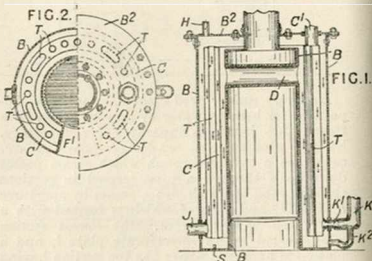

Heating water; vertical boilers.—A hot-water boiler for domestic supply and like purposes comprises an iron boiler provided with an inner copper boiler from which the supply is drawn, cold water being fed from one pipe to both boilers. An annular iron boiler B, which may be provided with a flat and readily detachable crown B^2 , is provided with an inner copper boiler C, which is mounted on iron supports S, and may extend completely round the combustion chamber above the firing-opening F^1 , or have the cross-sectional form of a horseshoe, as shown, throughout its height. Heating-tubes T, of circular, oval, or other suitable cross-section, and preferably made of thin sheet copper, may be passed through the copper boiler so as to cause the water to circulate in the directions indicated by arrows. One or more cross-tubes D may also be provided. Cold water from a pipe K is supplied through branches K^1 , K^2 to the respective boilers. The copper boiler is provided with the usual flow and return pipes C^1 , J respectively, and the iron boiler with the usual expansion pipe H.

25,325. Schloss, J. vom, Hopfner, E., Sauer, H., and Wilhelm, F. G. Oct. 31.
No Patent granted (Sealing fee not paid).

Portable water-heaters are formed of three telescoping vessels a, b, c, of which the vessel a contains a small spirit stove for heating the water in the vessel b. When the apparatus is extended for use as shown in dotted lines, the

vessel *b* is supported by means of brackets *f*, which engage slots *d* in hinged arms *e*, which are turned upwards from their normal position.

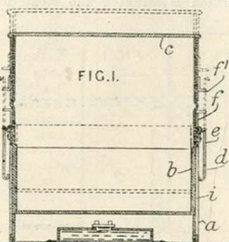

Slots *i* in the outer vessel *a* afford a supply of air to the stove and form guides for the free ends of the arms *e*. A door is provided in the vessel *a* for introducing the stove.

25,415. Carrington, H. C. James-
 May 2, 1911.

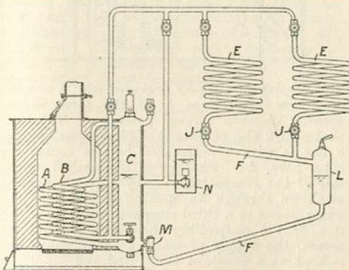

Heating liquids.—A low-pressure closed-circuit apparatus using superheated vapour for obtaining temperatures between 500° and 1500° F. for boiling liquids comprises a generating-coil *A* and a superheating-coil *B* placed in the same furnace. The coil *A* is connected to a reservoir *C* so as to be always flooded, and the coil *B* is connected to the top of the reservoir and leads to the heating-coils *E*. The condensate from the coils flows by a pipe *F* to a collecting-box *L* and thence to the reservoirs through the valve *M*. The proper level in the reservoir *C* is maintained by the filling-box *N*, which contains a pair of submerged valves, the lower a gravity valve for admitting fresh liquid when the apparatus cools, and the upper a loaded safety-valve. The superheated vapour of oil or mercury may be used in the apparatus, with or without a suitable stable gas such as hydrogen.

25,480. Thompson, J. K. Nov. 2.

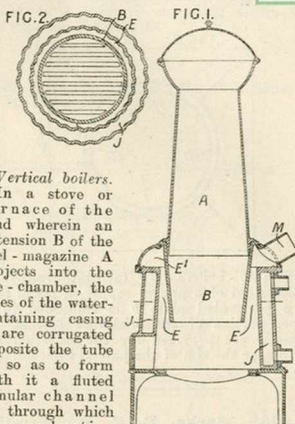

Vertical boilers.

—In a stove or furnace of the kind wherein an extension *B* of the fuel-magazine *A* projects into the fire-chamber, the sides of the water-containing casing *J* are corrugated opposite the tube *B*, so as to form with it a fluted annular channel *E*, through which the combustion products rise to the smoke chamber *E'* and the chimney *M*.

25,569. Sokopf, E. Nov. 10, 1909, [Convention date].

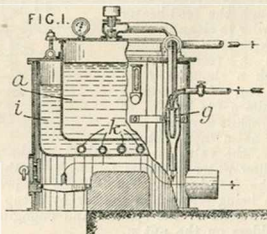

Digesters.—The sudden generation of steam on opening a steam cooker is prevented by cooling the contents before opening to or below the boiling-point of the liquid at atmospheric pressure. In the apparatus shown, the cooling may be effected by the water in the jacket *i* and a cold-water coil *k*; or the steam generated within the cooker may be passed through an ejector condenser *g* actuated by high-pressure cold water, a vacuum being thus formed in the vessel *a*.

26,402. Smith, G., and Smith, C. G.
Nov. 14.

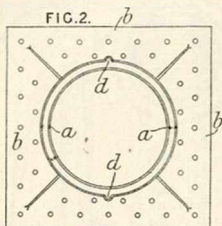

Washing-boilers.—To facilitate removal or replacement of a pan or copper, a metal rim *a* in a perforated plate *b* is embedded in the upper portion of the brickwork setting. Recesses *d* are provided for the insertion of a tool under the rim of the pan on removal.

26,425. Marks, E. C. R., [Trevithick, F. H.]. Nov. 14.

Feed-water, heating.—The clack-valve of a locomotive or other boiler is adapted to be raised so as to allow water or steam from the boiler to pass back through the feed-heater in order to clean it. The clack-valve *d* is formed with a recess *e*, in which a shoulder *f* on the end of a screwed spindle *g* fits loosely, so that, while normally acting as a non-return valve, the valve may be raised by the spindle to allow water or steam to pass from the boiler to the feed-heater. The spindle is prevented from being screwed in too far by a cap *l* fixed to the head of the spindle and engaging with shoulders on the nut *n*.

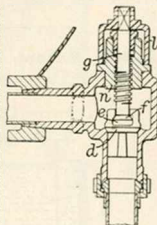

26,482. Morison, D. B. Nov. 15. [Cognate Application, 10,962/11.]

Feed-water, heating.—In apparatus for treating feed-water consisting of a casing with several compartments in which the water is freed from floating oil, heated by steam, and filtered, the steam is introduced in the form of jets under the water, and means are provided for controlling the supply of water to the feed-pumps. Various forms of filter are also described. In the apparatus shown in Fig. 1, the water enters by an inlet *i*, and flows over a

weir *l* into a compartment 1, where floating oil accumulates. From the bottom of the compartment 1, the water flows into a compartment 2, in which is situated the steam-jet device.

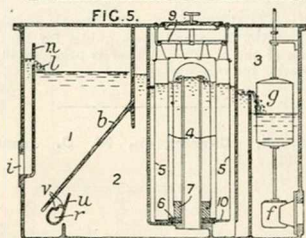
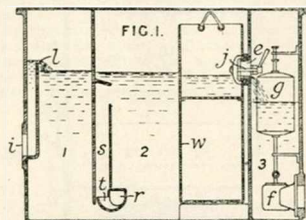

This consists of a pipe *r* provided with a number of hollow projections *t*, of the form shown, opening under a vertical passage *s*. The compartment 2 also contains the filter, consisting of a box *w* with a perforated bottom containing coke, fibre, &c. The box *w* is attached to the side of the compartment 2 by a bolt *j* passing as shown through an opening *e*, by which the water passes to a third compartment 3, in which is a float *g* controlling the outlet *f*. By this means, the supply of water to the feed-pumps is kept at a constant head, and the supply of water is rendered steady though the speed of the pump varies. The float *g* may also control the supply of steam for driving a feed-pump. In the form shown in Fig. 5, a second weir *n* is placed above the weir *l*, and the water flows between them, or it may flow through a row of holes in the weir *l*. The partition *b*, which separates the chambers 1, 2, is arranged diagonally, so as to allow a large surface for collecting floating oil without lessening the size of the heating-chamber. The steam-jet device consists of a pipe *r* with two perforated faces *v*, arranged in steps, and a flange *u*. The filter consists of two concentric cylinders of fabric 4, 5 suspended from a ring 9 and secured at their lower ends to disks 6, 10, which are held against the bottom of the chamber by a removable weight 7.

26,495. Morison, D. B. Nov. 15.

Feed-water, heating.—In systems such as are employed, for example, on ships, in which exhaust steam from auxiliary engines and steam generated in an evaporator are utilized conjointly for supplying steam to feedwater-heaters, low-pressure turbines, or other steam-heated or steam-driven devices, the steam generated in the evaporator is controlled in accordance with the steam pressure in the system or the temperature in the heater, so as to compensate for any surplus or deficiency in the supply from the auxiliary engines, and thus furnish an approximately constant joint supply. As shown in Fig. 1, the cock *l* that regulates the admission of steam to the heating-coils of an evaporator is controlled by a diaphragm *s* subject to the steam pressure in a reservoir *r*, into which the joint supply is delivered. In a modification, the diaphragm controls the discharge of drainage water from the heating-coils. In other modifications, a piston or diaphragm which controls the steam admission or the drainage-water discharge is operated by a thermal regulator located in a direct-contact feedwater-heater.

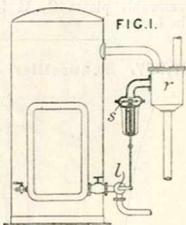

26,547. Coffin, A. G. Nov. 15.

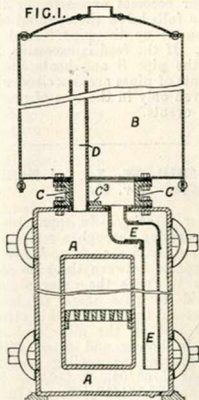

Vertical boilers.—A boiler A and reservoir B

are connected by a wide collar C, which encloses the tubes D, E through which a circulator is established. A plate C³ extending within the collar supports the tube D.

26,893. Smith, A. E. H., and Smith, C. H. Nov. 19.

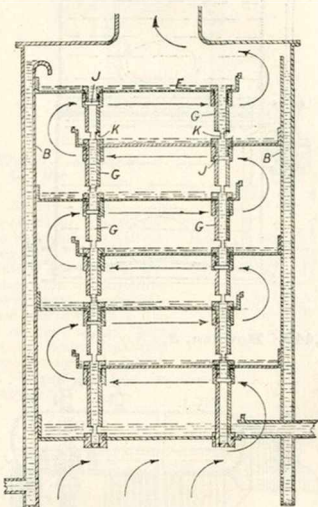

Geysers.—Water to be heated rises in the jacket B, falls on to the pan E, and passes through the openings K down those of the supporting-tubes G that are not closed by the plates J on to the succeeding pans. The pans may be fitted with covers.

27,129. Muchka, J. Nov. 22. [Addition to 29,099/09.]

Feed-water, heating.—Relates to modifications in the apparatus described in the parent Specification, in which an auxiliary pump of greater capacity than the feed-pump is employed for repeatedly circulating the feed through the heater. According to the present invention, an injector worked with exhaust steam, supplemented if necessary by live steam, is used for circulating the water. The Figure shows the arrangement. The injector is constructed as described in Specification 28,071/09.

(For Figure see next page.)

27,129.

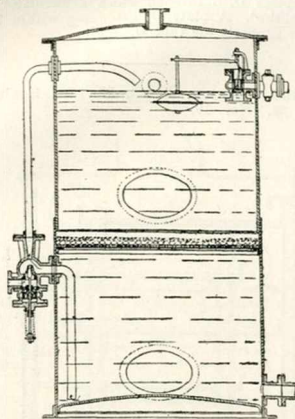

27,449. Howden, J. Nov. 25.

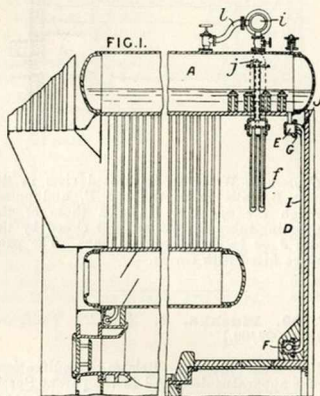

Feed-water, heating.—In a water-tube boiler, of the kind described in Specification 26,330/08, [Class 123, Steam generators], the back wall of the combustion chamber is formed by vertical tubes, in which the feed-water is heated. The back wall of the combustion chamber D is formed by feed-heating tubes I, which are connected to upper and lower transverse boxes E, F communicating with the upper boiler

drum A and the feed-supply pipe respectively. The tubes are preferably expanded into readily-removable plates G, H forming the backs of the boxes.

27,567. Peaucellier, A. Nov. 26.

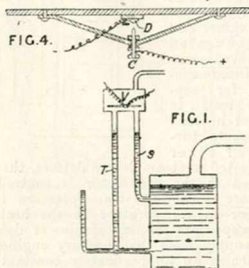

Safety arrangements.—In a low-pressure boiler provided with a stand-pipe serving as a safety-device, means are provided whereby the expansion of the stand-pipe, owing to steam or hot water passing through it on the occasion of an excess or shortage of feed or an excess of pressure, operates an alarm. The stand-pipe S communicates with a reservoir V whence a return pipe T passes to the bottom of the boiler. To the wall of the chamber V is attached a temperature alarm of the form shown in Fig. 4, consisting of two strips of inexpandable material attached to the wall and carrying a contact piece C, which the expansion of the wall brings into contact with the piece D. If the pressure in the boiler becomes excessive, or the water-level therein falls below the opening of the pipe S, steam passes up the pipe S and heats the chamber V. If the feed is excessive, hot water passes up the pipe S and heats the chamber. Arrangements of pipes are described whereby an alarm is given only in the case of one or two of these three events.

27,772. Still, W. J., and Still's Tube Syndicate. Nov. 29.

Feed-water, heating.—In apparatus for heating a fluid passing through a series of straight gilled tubes a, baffles e, f, g, h are employed to fill the spaces between the gills of adjacent tubes so as to cause the external heating or cooling fluid to pass more or less circumferentially round the tubes in thin streams. The baffles may rest on the gills, and certain of them may be hollow and fitted with further tubes for heating or cooling a third fluid. Specifications 5765/04, 29,510/04, [Class 99, Pipes &c.], and 27,774/10, [Class 64 (iii), Surface apparatus &c.], are referred to.

(For Figure see next page.)

27,772.

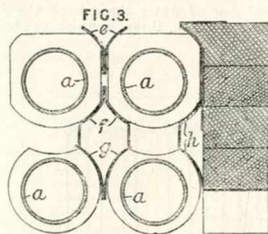

27,790. **Gonella, A., and Sacerdote, S.**
Dec. 11, 1909, [Convention date].

Set-pans.—The Specification as open to inspection under Section 91 (3) (a) comprises the following.—A vessel 1 containing food to be heated telescopes into an outer chamber 2 and is adapted when partly raised to be supported by hinged arms 10. The base of the chamber 2 is formed as a fire-grate and, when removed from the non-conducting box 3, is supported on adjustable feet 9. This subject-matter does not appear in the Specification as accepted.

(For Figure see next column.)

27,790.

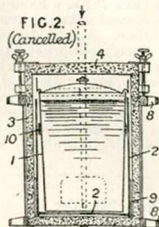

27,917. **Currah, J. C.**
Dec. 1.

Boiling-pans.—An open boiler is arranged to back through a dividing-wall *b* so that the flames &c. from a fire-place *c* in an adjoining room pass around its end and through a flue *a* or flues in that part of the boiler separated by a perforated plate *f*. A hinged lid may be provided.

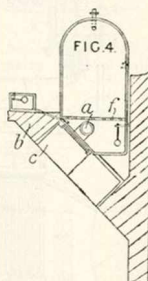

28,116. **Smith, J. A. Manners.** Dec. 3.

Portable water-heaters; water delivery.

—Apparatus for boiling water at a pre-arranged time comprises electromagnetic means coacting with a clock for controlling the gas supply and a heating-vessel possessing a siphon discharge and mounted on a tilting base. The heater *k*, with its siphon discharge *m*, is carried by a base *F*, which is pivoted at *P*, and from which two rods *d*, *r* project downwards. To the rod *d* is attached a spring *e* which is sufficiently strong to pull the heater into the tilted position when empty, the rod *d* making contact at *c₂*. When the heater contains water, it assumes the position shown in Fig. 1, and the rod *d* makes contact at *c₁*. The main gas-valve *D* is operated by a lever *q*, which is held in the 'off' position by a catch *w*. When the magnet *M* is

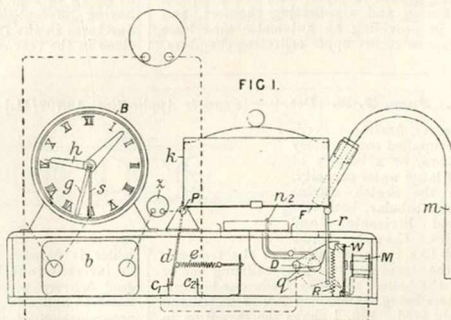

energized, the catch is removed, the lever *q* drawn down by the spring *R*, and the gas, which is now on, is ignited by the pilot light *n₂*. When the water boils, the steam pressure rises until sufficient to start the siphon, and the vessel *k* is emptied, eventually tilting up so

that the rod *r* draws up the lever *q* and turns off the gas. A clock *B* has a hand *g*, which can be adjusted to contact with the hour hand at a predetermined time. At the determined time, the completed circuit comprises the battery *b*, hand *g*, spring *s*, hour-hand *h*, clock *B*, magnet *M*, catch *w*, lever *q*, stop *c*, lever *d*, and switch *z* to battery. The catch *w* is released, the circuit is broken, and the boiling operation commences. When the heater is empty, the new circuit made includes the alarm, which is set ringing.

28,403. Siegel, H. Dec. 6.

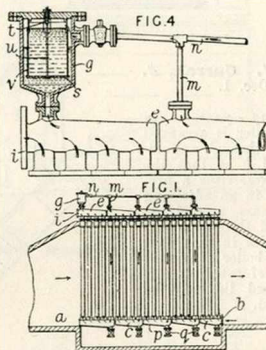

Feed-water, heating.—Relates to economizers comprising groups of pipes, each group having a distributing and a collecting chamber, and consists in providing an automatic air-release valve common to the upper collecting-chambers.

28,649. Parr, T. D. Dec. 9. [Cognate Application, 13,702/11.]

Feed-water, heating.—Feed-water is supplied continuously to one, two, or a battery of boilers of large water-capacity, such as the Scotch marine type, multi-tubular, both vertical and horizontal, and Lancashire, Cornish, Gallo-way and like types, at or about the temperature of the steam generated, by utilizing one or more of the boilers solely as feedwater-heaters, the heaters being maintained full of water and separately fired. Fig. 1 shows the invention in connexion with a battery of cylindrical boilers, in which feedwater-heaters 18 supply generators 17. To convert an existing battery of generators into heaters and generators it is merely necessary to disconnect the steam-pipe 19-20 and the feed-pipe 20-21 and connect the portions 20 as shown. The top of each heater

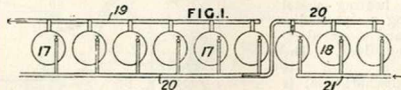

The pipes are also provided with regulable sections or resistances for the purpose of obtaining an equal flow of water through all the pipes. In the chamber *a*, through which combustion

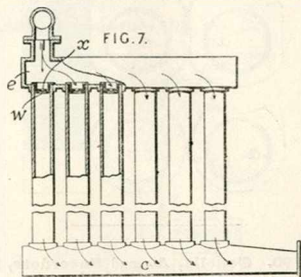

gases pass, are situated the water-pipes *b*. The water enters at *b*, the first distributing-box *c*, flows up to a collector *e*, thence passes to the second distributor, and so on throughout the series to the outlet *i*. To facilitate removal of sludge from the distributors *c*, they are provided with inclined bases *p* which slope down to the sludge-cocks *q*. The automatic release valve *t*, as shown in Fig. 4, is placed in a casing *g* communicating by pipes *m*, *n*, with the top of each collector *e*. The valve-rod *u* is attached to a diaphragm *s* at the bottom of vessel *r*, which is filled with water. When sufficient air accumulates, the diaphragm *s* is pressed down, and the valve *t* is opened to allow the air to escape. In order that the flow of water through the pipes shall be equal, cup-shaped fittings *w*, as shown in Fig. 7, are used, in which rings *x* having different-sized apertures are placed, the apertures in the front pipes being smaller than those in the rear ones.

boiler is fitted with a hollow truncated cone or inverted funnel (not shown) leading to the feed delivery pipe, which serves to collect the hot feed and also provides a small space for the accumulation of steam, when the temperature falls and the water contracts, for preventing water-hammering. To prevent the formation of steam in the heaters, the outlet is controlled by a pressure-regulating valve set to lift at or about the same pressure as the safety-valves on the generators.

28,691. Green, F. W., and Slade, H. Dec. 9.

Feed-water, heating.—

A feedwater-heater, of the kind consisting of upper and lower headers connected by tubes 6, located in the downtake at the back end of the boiler, and adapted to form part of the water-circulating system when certain valves are opened, is arranged so that the feed-water enters the boiler at the back end, as by a pipe 8, about or below the low-water mark, and, when the feed-water is shut off, the boiler water passes from the bottom front end of the boiler, as by a pipe 14, and through the heater, thus circulating completely through both boiler and

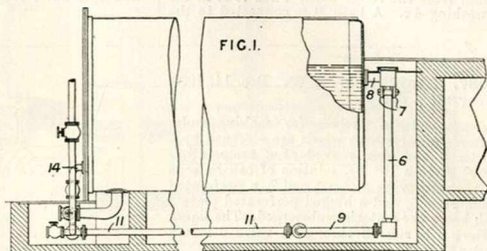

heater. The heater is preferably suspended by bars 7. The pipe 11 conveying the feed-water &c. to the heater is bifurcated at 9.

28,838. Burley, F. B., and Jones, E. Dec. 12.

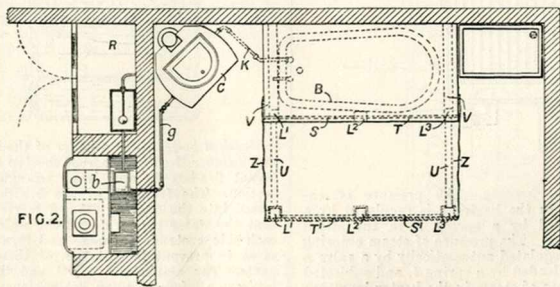
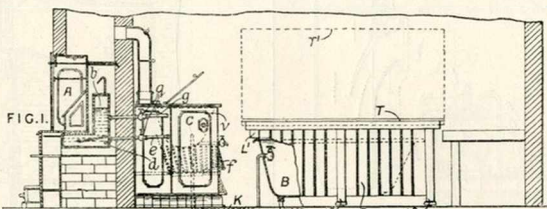

Kitchen-range boilers; washing-boilers.—Relates to combination ranges, coppers, and baths for use in artisans' dwellings. The non-pres-

sure boiler *b* of the range *A* is connected by circulating-pipes *e, g*, to the boiling-vat *v* of the copper *C*, which is provided with a fire-place *f*

for use when the range fire is not alight. Taps *g* in the pipes *e*, *g*, allow the copper to be isolated from the range boiler when it is in use for washing &c. A bath *B* is connected to the

copper or the range boiler by a pipe *K*; in either case a fire in the range or in the copper will heat water for the bath.

29,087. Stanley, J. C. W. Dec. 14, 1909, [Convention date].

Set-pans.—In a process for making pulp, splinters from resinous woods are screened by a cylinder 3 and then soaked at a temperature of 200° F. in a 10% Be. solution of caustic soda in a tank 4 having a steam coil 7, a perforated bottom plate 5, and a hinged perforated plate 8 which keeps the material submerged. The liquor is afterwards run off through a valve 6 into a digester.

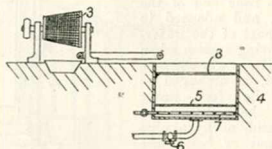

29,900. Caille, C. Jan. 31, [Convention date].

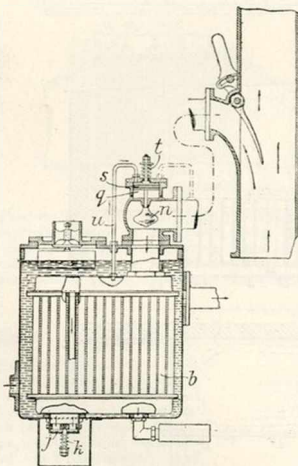

Feed-water, heating.—The pressure of exhaust steam in the heater *b* is regulated by a valve *j* loaded by a spring *k* in the steam escape passage. The pressure of steam entering can also be regulated automatically by a valve *n* in the inlet, loaded by a spring *t*, and subjected to the pressure of steam in the heater by means of a tube *u* and piston *s* in the cylinder *g*.

29,983. Jenkins, E. J., and Sweetland, A. W. Dec. 24.

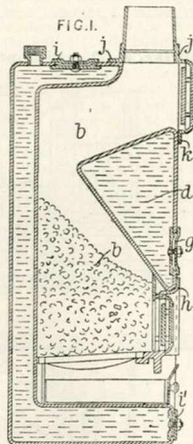

Vertical boilers.—In a boiler of the box form, the member *d* extends across the top of the internal fire-box *b*, and is of triangular or *D* section. The frame *h* of the fire door is recessed into the opening formed to receive it so that the water pocket *d* and the waterways on each side protrude outwards and forwards of it so as to prevent incrustation of these angular parts. The manholes *i*, *g*, *i'* and the frames *k*, *j* are all formed upon flat surfaces, and are of large area.

30,181. Lassen, J. J., and Hjort, V. F. Dec. 29.

Heating-water; feed-water, heating.—In a feed-water heater and purifier, steam enters by a shaft C into a separating-chamber B, and, rising through gauze partitions B', passes into a pipe D which leads into perforated steam-pipes D' lying in the water tank E. The steam escapes through the surrounding water, and, passing upwards, is met by the jets of water from the perforations J' in the corrugated distributing trays J which are supplied from a sprinkler G. Any uncondensed steam escapes by a shaft K. The heated water passes down through the stand-pipe E' into the chamber F and is drawn off by a pipe F' after passing through filtering-material F'. The water supply valve G² is controlled by the level of the water in the filter chamber.

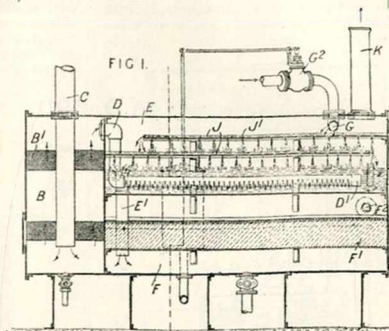
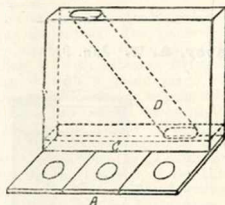

30,357. Bailey, G. Dec. 31.

Kitchen-range and like boilers.—A boiler suitable for resting on the back part of the hob or hot-plate A of a portable kitchen range is provided with an horizontal flue C and an inclined flue D, the flue C being formed below the raised bottom of the boiler.

30,378. Carlier, L. Savary. Jan. 6,
 [Convention date].

Heating water.—Water to be heated and purified is subjected, in the form of small drops issuing from a perforated pipe 14', to the action of an upward blast of exhaust or live steam in the expanded part 16 of a pipe 22. The particles of water and of impurities separated out are carried to a drum 20, where some part of the chalky &c. matter is deposited, the rest being carried by the steam to the bottom of a compartment 4 in a tank 1, purified water flowing over the partition 2 to

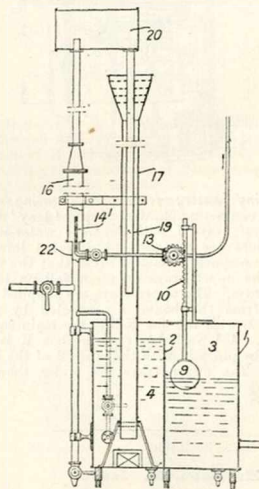
the compartment 3. The water level operates, by a float 9 and rack 10, a cock 13 controlling the admission of water to the tube 14'. Any



steam arriving at the bottom of the tube 19 is finally condensed in the annulus 17.

A.D. 1911.

154. **Lake, W. E.**, [Jones, J. C.]. Jan. 3.

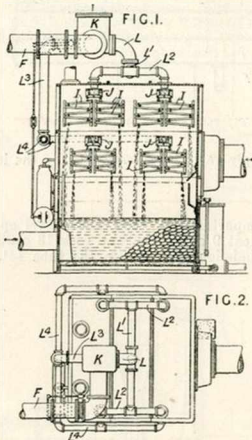

Heating water; feed-water, heating.—In direct-contact apparatus of the 'tray' type, groups of trays I with separate water-supply connexions are arranged at different levels in the steam space in such manner that the water from the upper trays does not fall on to the lower trays. The upper trays are supplied with water from the boxes J connected by pipes L², L¹, L with the box K and the main supply-pipe F. A branch L³ from the box K is connected by pipes L⁴ with the boxes J of the lower trays. The upper trays are wider than the lower.

330. **Harrison, M.** Jan. 5.

Water delivery.—A tank boiler for a gas cooking-stove has a float-supported pipe 21 swivelled at 22 so as to draw off the hottest water.

(For Figure see next column.)

330.

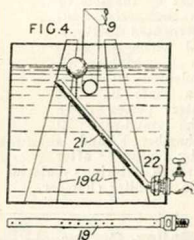

574. **Davey, A. T.** Jan. 9.

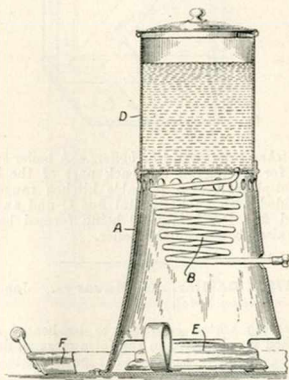

Portable water-heaters.—Relates to improvements in the accessories of water-heaters of the type in which the water flows from a tank through a coil exposed to the flames of a lamp &c. The lamp E is surrounded by a casing A on which is mounted a water-vessel D from which the water passes through a coil B. The casing A may be secured to a tray F. To keep the heated water that has been run off into a

receptacle hot, the waste heat from the lamp is utilized. This may be done by forming the receptacle of a crescent shape to fit to the side of the casing A. A bracket may be attached to the casing A to support the receptacle. A socket may be formed in the receptacle to receive a razor-blade.

625. Bone, W. A., Wilson, J. W., and McCourt, C. D. Jan. 10.

Submersible water-heaters.—A submersible device for heating liquids &c. by combustion processes like those described in Specifications 29,430/09 and 4362/10, [both in Class 51 (i), Furnaces &c., Combustion apparatus of], is shown in Fig. 1. It comprises a packed tube C, which is substantially the same as one of the packed tubes described in the later of the before-mentioned Specifications, but is independent of, and removable from, the vessel containing the liquid. The joints J are auto-generously welded, and the nozzle C is secured by winding it with asbestos string and then plastering it with a paste made of crushed burnt fire-clay and viscous sodium silicate. In modifications, two packed tubes are connected to one gas and air supply pipe A, and dome-like caps with perforated tops may be used. In a further modification, the gas and air mixture is supplied to the top end of the tube C, and the bottom end, which is fitted with a closure, is perforated to allow the burnt gases to escape into and through the liquid. For treating acids, the tube C may be of iron coated with lead, or of copper or iron nickel-plated or otherwise coated. The lead-coated tubes are preferably lined internally with fire-clay.

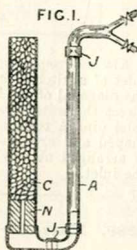

942. Lindskog, F. Jan. 13.

Heating water; portable and small water-heaters.—In appliances for heating water and generating steam in which combustion products flow downwards through an annular space surrounded by the water to be heated the water-chamber is surrounded by a casing containing water which intercepts escaping heat and passes, thus warmed, into the heating-chamber. The burner or other heater *a* is surrounded by a tube *b*, between which and the water-chamber *d* is an annular space *c* down which the combustion products pass. The chamber *d* is contained in a casing *h* and separated from it by a hollow partition *m* containing asbestos &c. The partition *m* is held against the bottom of the casing *h* by a pivoted rod *n* and nut. Water enters

the lower part of the chamber *d* from the part of the casing *h* by a pipe *e*. Steam or water leaves the chamber *d* by a pipe *f*.

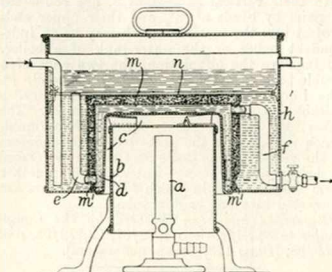

1288. Foster, W. Jan. 18.

FIG. 2.

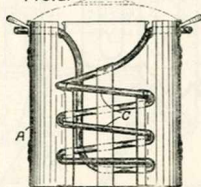

Boiling-pans.—A vessel *A* for heating liquids is provided with a removable steam coil *C* so fitted that it can be readily detached without the making and unmaking of joints in the steam piping near to the vessel.

Reference has been directed by the Comptroller to Specifications 15,689/89, 8688/92, and 3613/96.

1529. Maslin, E. Jan. 20.

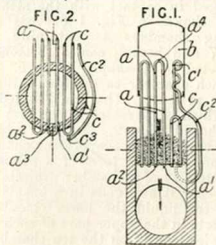

Heating water.—A down-draught furnace grate is formed by bent endless tubes in which

a liquid circulates, part of the tubes projecting into a vessel to heat the liquid therein. In the form shown in Fig. 1, the grate bars a^1, a^2 , with their vertical extensions a , are connected in pairs by bends a^3, a^4 , and their upper ends project into the vessel b , which may be an independent boiler or the water-tank of a boiler. To improve the circulation, the two ends of a double tube c may be connected by a tube c^1, c^2 . The liquid in the tubes may be mercury, a suitable oil, a saline solution, or water. The tubes may be only partly filled with a liquid, which vaporizes in the grate bars and condenses in the vessel b . The grate may be partly formed of bricks or refractory material, and another form is illustrated in which four grate bars are connected into one endless tube.

Reference has been directed by the Comptroller to Specifications 1629/07, 22,272/02, and 7359/98, [Class 123, Steam generators].

1832. Liese, H. M. Jan. 26, 1910, [Convention date].

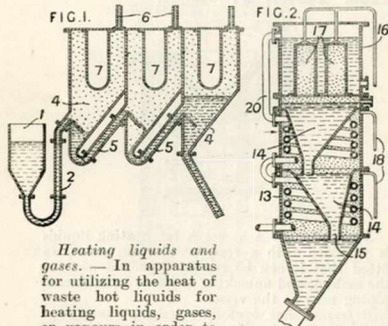

Heating liquids and gases.—In apparatus for utilizing the heat of waste hot liquids for heating liquids, gases, or vapours in order to avoid incrustation of the heat-exchanger by matter precipitated from the waste liquid, steam is generated from the liquid by reducing the pressure, and the heat-exchanging surfaces are arranged in contact with the steam. The apparatus shown in Fig. 1 consists of three evaporating chambers 4 containing heat-exchangers 7 and having conical bottoms which are connected by U-shaped pipes 5. Pipes 6 connect each chamber to the apparatus for reducing the pressure. The liquid is fed from a vessel 1, which is connected to the first chamber by a U-shaped pipe 2. In the modification shown in Fig. 2, the evaporating-chambers 13 are superposed in the form of a column. The conical bottom 14 of a chamber projects into the chamber below it and ends in a tube 15, which dips into the liquid the lower chamber. The steam collects in the upper part of each chamber and in projections 17 on the top chamber. The projections 17 are enclosed in a tank 16 to which the liquid &c. to be heated is fed. A pipe 20 conveys the liquid &c. from the tank into coils

in the evaporating-chambers. Pipes 18 connect the chambers to the apparatus for reducing the pressure.

2300. Gibson, W. J. Jan. 30.

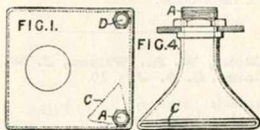

Kitchen-range and like boilers.—The water inlet of a kitchen-range boiler is directed along the diagonal of the boiler and arranged so as to direct the water over the bottom thereof. The inlet pipe A terminates in a wide flat nozzle C shaped and arranged as shown. The outlet D is arranged at one of the corners adjacent to the inlet.

2339. Hart, C. Jan. 30.

Heating water; vertical boilers.—

A storage tank 1, for connexion with a range boiler by means of pipes 2, 3, is provided with means for heating the water while in the tank independently of, or to augment the heating effect of, the range fire. As shown in Fig. 1, water coils 13 in a central chamber are heated by a gas burner 18.

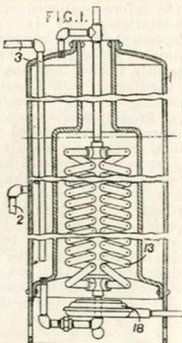

2388. Clausen, C. Jan. 31, 1910, [Convention date].

Feed-water, heating.—Apparatus for heating feed-water and removing oil &c. therefrom and adapted to be arranged on the suction side of the feed-pump comprises a casing divided into two compartments A, B. The feed enters the compartment A through a pipe C, which is formed with a bend, as shown, and with two outlets discharging horizontally just below the water-level. The oil accumulates on the surface of the water and is removed by a skimmer cup D. The feed then passes through the openings F into the compartment B, where it is heated

by steam from a perforated pipe G. A float-operated valve K controls the outlet to the suction pipe of the feed-pump.

(For Figures see next column.)

2393. Lawrie, W. Jan. 30.

Portable and small water-heaters.—Apparatus for heating water for heating greenhouses &c. comprises a boiler A with a central passage B serving as the chimney for the burner I. A hollow canopy F is arranged above the chimney and is connected by pipes C, D to the boiler A. An expansion chamber J is provided on the upper side of the canopy, which is connected to the flow pipes G. Glass-covered inspection holes K may be formed in the chimney B and in the boiler A, to which the return tubes H are connected.

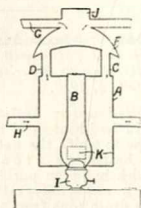

2388.

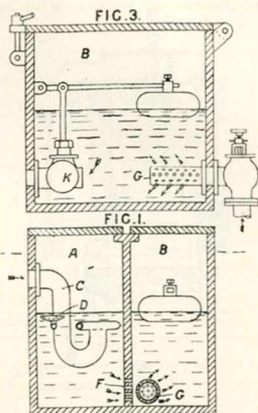

2404. Bone, W. A., Wilson, J. W., and McCourt, C. D. Jan. 31.

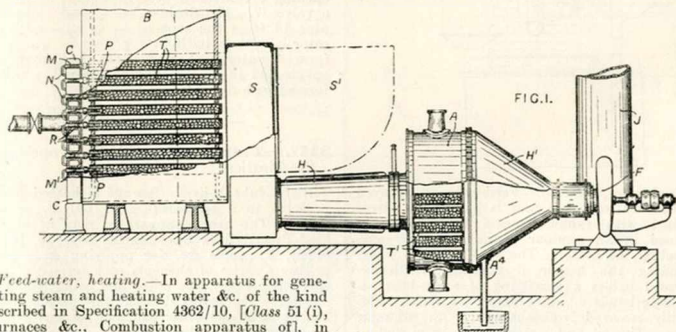

Feed-water heating.—In apparatus for generating steam and heating water &c. of the kind described in Specification 4362/10, [Class 51 (i), Furnaces &c., Combustion apparatus of], in which a mixture of gas and air is burnt in tubes packed with refractory material, the combustible mixture is drawn into and through the tubes by the suction of a fan. The apparatus shown comprises a multitubular boiler B and feed-heater A, each having tubes T, T', respectively, packed with broken fire-brick, magnesite, or other similar refractory material. Gas and air supplied to the tubes T burn amongst the refractory

material therein, and the products of combustion are drawn by the fan F through the smoke-box S, flue H, tubes T', and flue H', and delivered to the chimney J. Any moisture which condenses in the tubes of the feed-heater is led off through a water-sealed pipe A'. The feed-heater has removable ends to facilitate the packing of the tubes.

2563. Morison, D. B. Feb. 1.

FIG. 1.

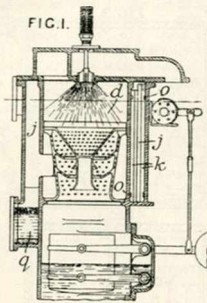
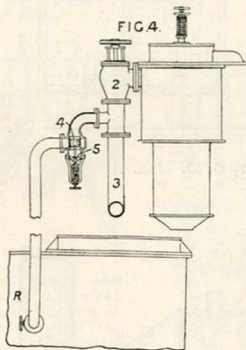

FIG. 4.



Feed-water, heating.—Feed-water is sprayed in the heating-vessel and is heated by direct contact with exhaust steam that has been cleaned in an annular steam-separator surrounding the heater. The annular space *j* surrounding the heater *d* contains vertically-disposed baffles *k* consisting of angle-bars attached to bands *o*, which allow the baffles to be readily removed from the top of the annular space. The oil and water collect in a well *g*, which is provided with a vertical partition to facilitate the separation of the oil from the

3786. Weir, W. Feb. 15.

Feed-water, heating.—Feed-water is heated in two stages, first in a direct-contact heater, and then in a surface heater, exhaust steam from the auxiliary machinery being utilized for heating. The turbine *b* exhausts into the main condenser *c*, from which air and water are with-

drawn by the pump *d*. The feed is discharged through the filter *e* to the direct-contact heater *f*, and then to the feed-tank *g*. The heater *f* is heated by steam from the auxiliary exhaust main *k*. The feed-pump *q* draws the partly-heated water from the tank *g* and pumps it

3042. Alexander, A. E., [Wharton, J. S. L., Hallowell, W. S., and Jones, J. C., (trading as Harrison Safety Boiler Works)], Oct. 4, 1910.

Feed-water, heating.—In feed-heaters of the type in which the water is heated by steam which has been purified in a steam-separator, the drain pipe from the steam-separator passes to the overflow chamber of the heater, leaving a gap which prevents steam from passing to the heater through the drain pipe when the ordinary passage is closed. The separator chamber *2* communicates with the heater by an opening *8* controlled by a valve *17*. The drain-pipe *14* from the separator is bent on itself to form a water seal, and opens just above an opening *12* in the overflow chamber *3*, which is formed with a water seal.

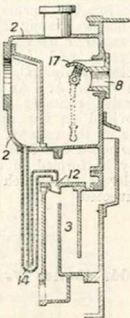

3247. Testrup, N. Feb. 8. Drawings to Specification.

Water-tube boilers.—Sewage is heated under pressure to a temperature of 130° C. or upwards. The heating-apparatus may be of the kind described in Specification 6041/10, [Class 51 (ii), Furnaces &c. for applying &c.], comprising a series of elements each formed of two concentric tubes, the outer one being closed at one end. The material enters the space between the tubes at the other end and returns by the inner tube, the closed end of the apparatus being placed in a furnace or otherwise suitably heated.

through the surface-heater r to the boiler s . This heater receives exhaust steam from the pump engine t , fan u , or other auxiliary machinery. A modification is described in which

the engine-room auxiliaries discharge direct through an oil extractor to the heater r and not through the medium of the auxiliary exhaust main.

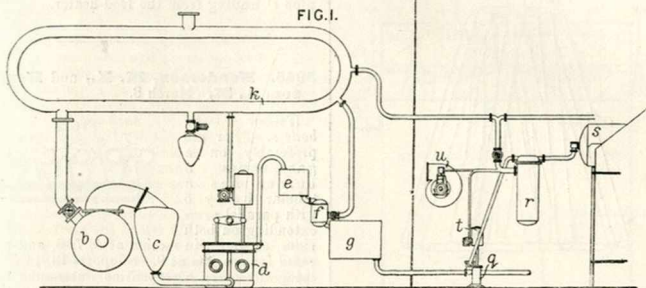

4144. Benn, C. July 6.

Set-pans.—In the construction of the bottoms of stills composed of a crown-plate b , an intermediate annular plate c , and an outer annular plate e for joining the plate c to the wall a of the still, the plate e is made of a shallow flat-bottomed trough-shape with an outer vertical flange d , and an inner sloping flange f . The flange d may be replaced by an angle-ring d' , as shown in Fig. 1. The inner edge of the foundation g lies within the outer edge of the flange f , so that the joint between the flange and the plate c is protected from the flame. Further protection may be afforded by covering the joint with clay &c. h .

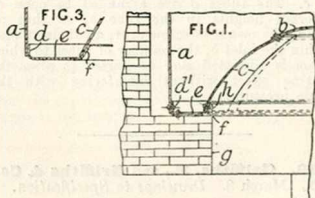

4743. Blair, C. Feb. 25.

Digesters.—A apparatus for devulcanizing waste rubber comprises a rotatable steam-jacketed vessel provided with stirrers and hollow journals for the admission of steam to the jacket and water to the vessel. A vessel A with steam-jacket B is mounted in bearings D and provided with stirrers M which pass between fixed stirrers L . Rubber and ingredients such as caustic soda or the like are placed through manhole doors K' , steam is admitted to the jacket B by a pipe C ,

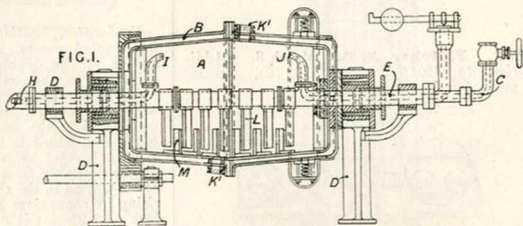

the rubber is sprayed with water from a nozzle I , and the vessel is rotated. A pipe J leads to a safety-valve E .

5251. **Chambers, M. F., and Skilton, C. F. E.** March 2.

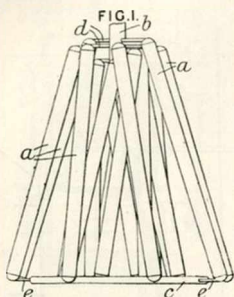

Boiling-pans.—For boiling liquids, especially brewers' wort, a large number of steam tubes *a* are arranged in a boiling-pan, and are connected to inlet and outlet tubes *b, c* by tubes *d, e*. The tubes *d* are arranged to open at different heights in the tube *b*, so that on sliding, by means of screw gear, a tubular piston within the inlet *b*, the number of tubes to which steam is admitted may be varied to alter the heating effect without interfering with the steam pressure.

5319. **Griffiths, E., and Griffiths & Co., D.** March 3. *Drawings to Specification.*

Water-tube boilers.—Water-heating pipes lining a grate, or otherwise placed so as to be heated on one side only, are given a half-twist at intervals, or provided with internal baffles, to give the water a rotary motion and cause uniform heating.

5799. **Fletcher, J. E.** March 8. [*Addition to 4594/10, Class 123 (ii), Steam-generators.*]

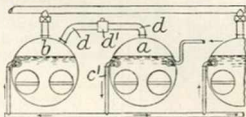

Feed-water, heating.—In a battery of separately heated generators comprising one or more generators acting as a feed-heater, as described in the parent Specification, the steam space of the feed-heater *a* is connected to a generator *b* by a pipe *d* containing a reducing valve *d*.

The feed is thus raised to a temperature at least equal to that of the steam generated in the battery, and the extra pressure in the feed-heater ensures the feeding of the generators. A reducing-valve may also be placed in the feed-pipe *c* leading from the feed-heater.

5845. **Henderson, M. K., and Henderson, A. M.** March 8.

Water-tube boilers.—For use preferably on a gas range, a burner has a tubular body *5* with parallel arms extending on both sides, as shown in section at *6, 7, 8*, and perforated for gas jets at *9*. Supports *13, 14* formed integrally carry a serpentine water-tube *10*, so that when in use, the water flowing there-through is heated.

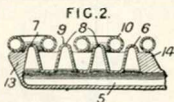

5951. **Lake, W. E., [Jones, J. C.]** March 9.

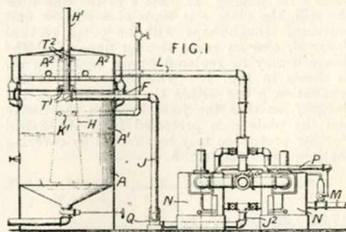

Feed-water, heating.—Water to be purified and heated enters, through the pipe *P*, one section of the double heaters *N*, where it is subjected to the action of steam. Thence it passes by the pipe *J*², pump *Q*, and pipe *J* to the upper end of the downwardly-extending member *H* in the vessel *A*, a chemical precipitant being added in the pipe *J*. In the vessel *A*, it is further heated by steam from jets *K*¹, air &c. escaping from the vent *H*¹. Impurities are deposited in the chamber *A*¹, the water then rising by connexions *F* to duplicate filter chambers *A*². Thence it flows by the pipe *L* to the second section of the heaters *N*, and is finally conveyed to the feed-pump or boilers through the pipe *M*. The filter chambers are fitted with by-passes communicating above and below the filter beds at *T*², *T*¹. These may be made with a path for liquid in \cap formation to increase the head, and may be fitted with vent pipes.

5954. **Lake, W. E.**, [Jones, J. C.].
 March 9.

Feed-water, heating.—Water enters the settling-chamber A^1 through the centre pipe H^1 from a preheater I , mounted on top of the tank A , and which is shown as a direct-contact feed-heater. Excess steam and air escape at I^4 . The feed-water rises through filter chambers A^2 fitted in the upper part of the chamber A , and passes to a final heater, which may be attached to the side of the tank A or may be separate. The steam supplied to the heater I may be excess steam from the final heater. A valve operated by a float may control the supply of water to the apparatus in accordance with the level in the final heater. A chemical precipitant is added to the water on or before entering the tank A from the heater I . Safety by-passes N , opening at N^1 above and below the filter beds, are fitted round the chambers A^2 to allow water to pass if the filters G^1 become choked. Steam may be injected through the pipe P into the passage H to agitate the water and facilitate de-aeration.

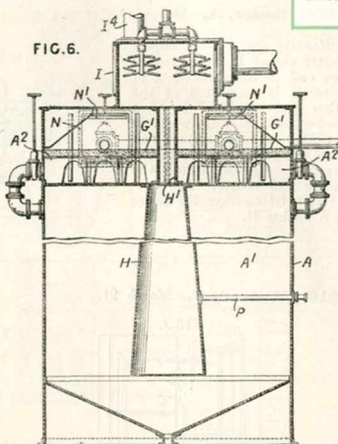

6201. **Owen, A. E.** March 13. *Drawings to Specification.*

Feed-water, heating.—In a superheater placed

in the smoke-box of a multitubular boiler a steam pipe is provided to allow steam to pass from the superheater to the feed-tank when the engine is not running.

6296. **Sauer, A.** March 13.

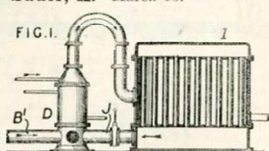

Heating water.—The gases from blast and like furnaces are drawn by an ejector through a feedwater-heater D and delivered to a condenser I , where they are cooled by air which is afterwards delivered to the gases entering the water-heater. The water-heater comprises a vertical multitubular boiler D^2 having at its lower end a chamber D^1 to which the gases from the furnace and the air from the condenser are supplied through valve-controlled pipes B^1 , J respectively, and at its upper end a conical casing F^1 through which steam is delivered to draw the gases from the furnace. The casing has an annular steam channel F^2 and a number of spirally-arranged discharge passages F^3 .

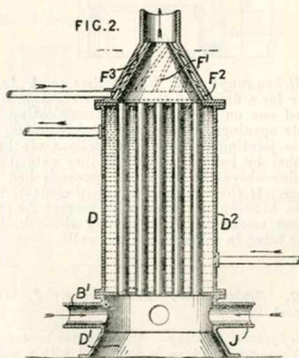

5251. **Chambers, M. F., and Skilton, C. F. E.** March 2.

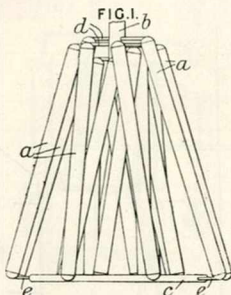

Boiling-pans.—For boiling liquids, especially brewers' wort, a large number of steam tubes *a* are arranged in a boiling-pan, and are connected to inlet and outlet tubes *b, c* by tubes *d, e*. The tubes *d* are arranged to open at different heights in the tube *b*, so that on sliding, by means of screw gear, a tubular piston within the inlet *b*, the number of tubes to which steam is admitted may be varied to alter the heating effect without interfering with the steam pressure.

5319. **Griffiths, E., and Griffiths & Co., D.** March 3. *Drawings to Specification.*

Water-tube boilers.—Water-heating pipes lining a grate, or otherwise placed so as to be heated on one side only, are given a half-twist at intervals, or provided with internal baffles, to give the water a rotary motion and cause uniform heating.

5799. **Fletcher, J. E.** March 8. [*Addition to 4594/10, Class 123 (ii), Steam-generators.*]

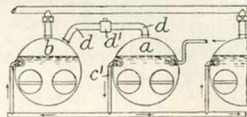

Feed-water, heating.—In a battery of separately heated generators comprising one or more generators acting as a feed-heater, as described in the parent Specification, the steam space of the feed-heater *a* is connected to a generator *b* by a pipe *d* containing a reducing valve *d'*.

The feed is thus raised to a temperature at least equal to that of the steam generated in the battery, and the extra pressure in the feed-heater ensures the feeding of the generators. A reducing-valve may also be placed in the feed-pipe *c'* leading from the feed-heater.

5845. **Henderson, M. K., and Henderson, A. M.** March 8.

Water-tube boilers.—For use preferably on a gas range, a burner has a tubular body 5 with parallel arms extending on both

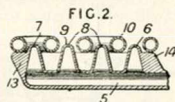

sides, as shown in section at 6, 7, 8, and perforated for gas jets at 9. Supports 13, 14 formed integrally carry a serpentine water-tube 10, so that when in use, the water flowing there-through is heated.

5951. **Lake, W. E., [Jones, J. C.]** March 9.

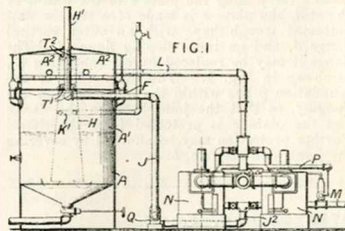

Feed-water, heating.—Water to be purified and heated enters, through the pipe *P*, one section of the double heaters *N*, where it is subjected to the action of steam. Thence it passes by the pipe *J*², pump *Q*, and pipe *J* to the upper end of the downward-extending member *H* in the vessel *A*, a chemical precipitant being added in the pipe *J*. In the vessel *A*, it is further heated by steam from jets *K*¹, air &c. escaping from the vent *H*¹. Impurities are deposited in the chamber *A*¹, the water then rising by connexions *F* to duplicate filter chambers *A*². Thence it flows by the pipe *I* to the second section of the heaters *N*, and is finally conveyed to the feed-pump or boilers through the pipe *M*. The filter chambers are fitted with by-passes communicating above and below the filter beds at *T*², *T*¹. These may be made with a path for liquid in Γ formation to increase the head, and may be fitted with vent pipes.

5954. **Lake, W. E.**, [Jones, J. C.].
 March 9.

Feed-water, heating.—Water enters the settling-chamber A^1 through the centre pipe H^1 from a preheater I , mounted on top of the tank A , and which is shown as a direct-contact feed-heater. Excess steam and air escape at I^4 . The feed-water rises through filter chambers A^2 fitted in the upper part of the chamber A , and passes to a final heater, which may be attached to the side of the tank A or may be separate. The steam supplied to the heater I may be excess steam from the final heater. A valve operated by a float may control the supply of water to the apparatus in accordance with the level in the final heater. A chemical precipitant is added to the water on or before entering the tank A from the heater I . Safety by-passes N , opening at N^1 above and below the filter beds, are fitted round the chambers A^2 to allow water to pass if the filters G^1 become choked. Steam may be injected through the pipe P into the passage H to agitate the water and facilitate de-aeration.

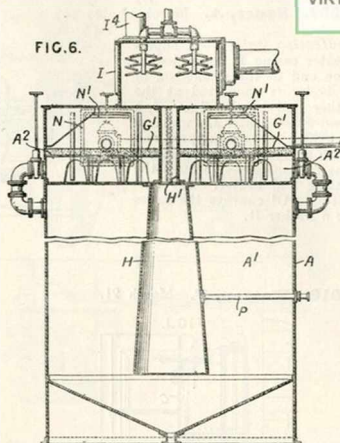

6201. **Owen, A. E.** March 13. *Drawings to Specification.*

Feed-water, heating.—In a superheater placed

in the smoke-box of a multitubular boiler a steam pipe is provided to allow steam to pass from the superheater to the feed-tank when the engine is not running.

6296. **Sauer, A.** March 13.

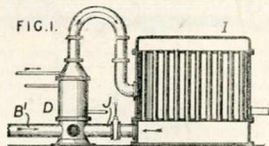

Heating water.—The gases from blast and like furnaces are drawn by an ejector through a feedwater-heater D and delivered to a condenser I , where they are cooled by air which is afterwards delivered to the gases entering the water-heater. The water-heater comprises a vertical multitubular boiler D^2 having at its lower end a chamber D^1 to which the gases from the furnace and the air from the condenser are supplied through valve-controlled pipes B^1 , J respectively, and at its upper end a conical casing F^1 through which steam is delivered to draw the gases from the furnace. The casing has an annular steam channel F^2 and a number of spirally-arranged discharge passages F^3 .

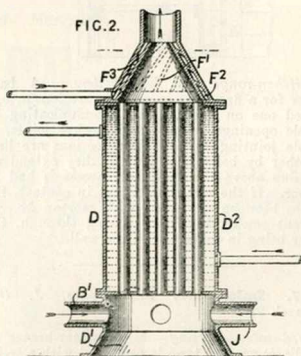

the rate of flow may be directly indicated. The water supply, or in this case the 'make-up' water, may be controlled by a valve G^2 actuated by a float G^1 in the outlet compartment E^2 . In cases where the pressure in the compartment E^1 exceeds atmospheric, compensating devices are employed to correct the movement of the stem H^1 . In a modification, the recording arm is actuated by a float with an attached cam shaped so that the flow is directly indicated. When more than one notch is used, the flow over one only is measured. Modifications are described, in which the heater and meter are separate structures, and also in which the float of the recording device is in a separate chamber with pipe connexions to the water and steam spaces of the heater. Figs. 14 and 15 show apparatus in which the head of water above the weir is measured hydrostatically. A tube T extends into the compartment E^1 with its open end immersed to the level of the apex E^{10} of the discharge notch. A pipe T^1 leads to the pressure chamber T^{10} formed by a cupped portion T^{11} closed by a diaphragm T^{12} , of which the central portion T^{13} bears against a lever T^{30} pivoted to a piece T^{24} . To compensate for the varying vapour pressure in the compartment E^1 , a pipe t^1 connects the compartment with a pressure chamber t^{10} similar to T^{10} and having a central portion t^{15} bearing on the opposite side of the lever T^{30} . The varying thrust on the lever T^{30} is balanced automatically so as to prevent any substantial movement of the diaphragms. A spring U connects the lever T^{30} to a tension-adjusting member U^1 , which is in the form of an apertured plate about a cam U^2 . Very slight movements of the lever T^{30} to the left or right, caused by the difference of pres-

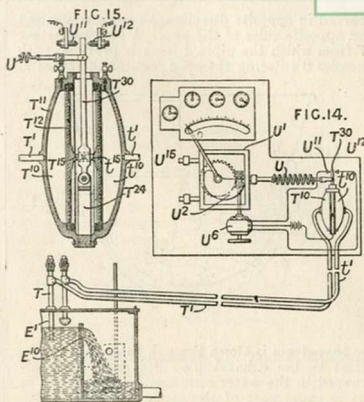

sure exerted by the diaphragms, close electric circuits through contacts U^{11} , U^{12} , thereby actuating a motor U^6 , which moves the cam U^2 and plate U^1 and relieves or increases the tension of the spring U so that the lever moves out of engagement with the contacts. By giving the cam U^2 the proper contour the angular movement of attached arm U^{15} may indicate the flow at any instant. The pressure-transmitting medium may be water or air.

7873. Jones, C. J., and Still & Sons, W. M. March 29.

Heating water; water supply and delivery.—In an appliance for drawing off hot and cold water into lavatory basins &c. the water is heated by being forced in jets through steam contained in the space between two concentric perforated tubes. The water enters a chamber y in the base d and passes up the tube w . The tube w is surrounded by a tube p , into which steam passes from a chamber o . In the tubes p , w are perforations 1, 2 placed opposite to each other and the whole is surrounded by a casing s fitted with a spout 4. The entrance of water to the chamber y and of steam to the chamber o is governed by valves operated by levers 5. The levers 5 are mounted loosely on a spindle 6 by means of bosses 9, which engage each other as shown in Fig. 5, so that the water-valve can be opened without opening the steam-valve, but not conversely.

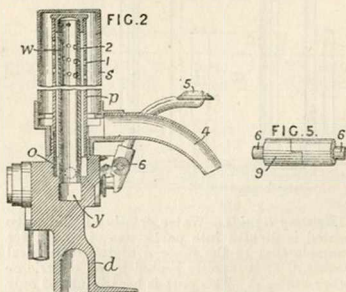

7886. Robertson, D., and Green, B. E. March 29.

Set-pans.—A steam-heated jam boiler consists of a pan 1 having a set of tubes 2 of oval section

running through it and a jacket 3 provided with perforated steam-pipes 4, the tubes 2, 4 being

6297. Sauer, A. March 13.

Heating water.—A superheater casing H connected at one end to the smoke-box of a boiler is connected at the other end to the flues of a feed-water heater L², which is provided at its upper end with an ejector O for drawing the furnace gases through the casing and heater. The outlet-pipe O⁴ conveys the gases to a washer R.

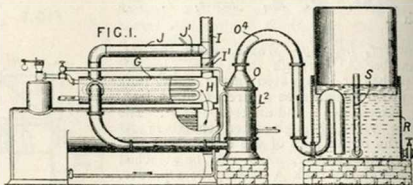

7016. Watson, F. March 21.

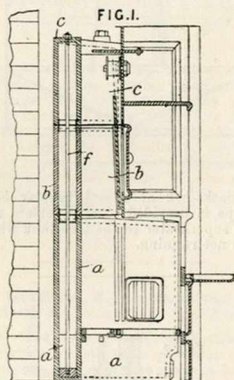

Kitchen-range and like boilers.—A back boiler for a fire-place is made in sections a, b, c placed one on another and communicating by simple openings, spigot-and-socket joints, or nipple jointing-pieces. The sections are held together by bolts f, and when they extend up the flue above the fire-place, access is had by a door. If the sections are not in contact, the spaces between are filled with mortar &c., to prevent smoke &c. from passing through, the boiler being in contact with the wall.

7177. Lake, W. E., [Jones, J. C.],
March 22.

Feed-water, heating.—A feedwater-heater of the direct-contact type is combined with a weir-type meter for measuring the heated water drawn off. In the form shown in Figs. 1 and 2, the heater A and measuring-device E communicate by the orifice A⁶, through which the heated and filtered water passes into the first compart-

ment E¹ of the meter. A baffle E³, with one or more discharge notches E⁴, separates the compartment E¹ from the compartment E², whence the heated water is withdrawn by a pipe F. A

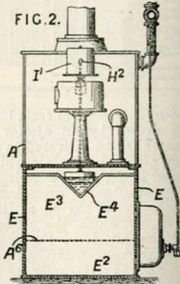
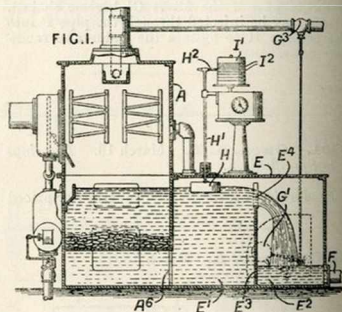

float H, moving in accordance with the water-level in the compartment E¹, has a stem H¹ with a pen H² attached, whereby a record of the level is obtained on the rotating drum I¹. Graduation lines I² may be formed on the drum so that

curved in opposite directions so as to run round on opposite sides of the pan. A steam chamber 7 from which the pipes 4 issue is provided with nozzles 8 entering the open ends of the tubes 2,

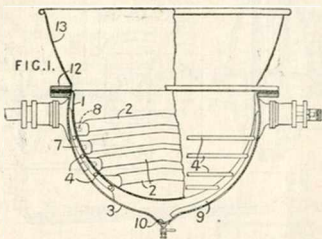

so that steam is blown through these tubes. The inlet to the exhaust pipe 9 is preferably arranged in the water condensation pocket 10, so as to cause part of the condensed water to be ejected through the pipe 9; the remainder of the condensed water is run off by a cock. An upper course 13 of copper is provided, and the parts 1, 3, 13 are secured together by clamping their flanges between steel rings 12, as shown.

7936. Cooper, W. R. March 30.

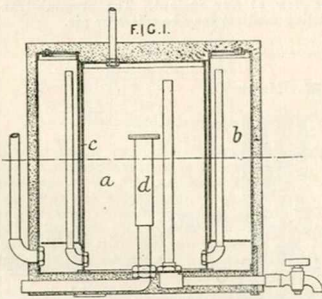

Heating liquids.—Water or other liquid to be heated is divided into parts, one of which, for example that in the inner *a* of two cylindrical vessels *a, b*, is directly heated by an electric or other heater *d*. This part is heat-insulated only to such an extent as to ensure rapid heating, heat being also transferred to the other part or parts so as to form a water heat storage or reservoir. In the example shown, the insulation is an air casing *c*.

8414. Gambati, O. F. June 6, 1910, [Convention date].

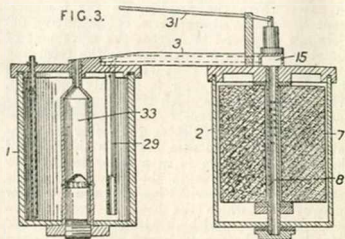

Portable and small water-heaters.—Water, introduced into the filter chamber 2 through the inlet 41, passes through a block 7 and a perforated central tube 8 to a chamber 15, 16. Its passage thence is controlled by two valves 21 operated by levers 31. One allows the cold filtered water to pass direct to an outlet situated near to the inlet 41 on the hollow bridge member 3; the other causes it to pass through a second duct in the bridge 3 to the tube 29 in the chamber 1 heated by any means in the central space 33. The heated water then passes to the outlet by a continuation of the first-mentioned duct in the bridge 3.

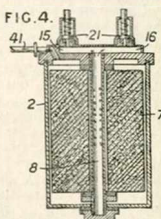

8471. Marshall, L. April 5.

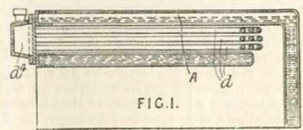

Heating water; boilers.—In boilers of the type in which two bodies of water circulate through the boiler and are heated without intermingling, one of the bodies of water passes through a set of U-tubes arranged in the flue or the water space of the boiler and connected to a casing divided into entrance and exit compartments. Fig. 1 shows a boiler *A* in which the U-tubes *d* are arranged in the flue and connected to a casing *d'* attached to the side of the boiler and divided by a vertical partition.

8616. **Gonella, A., and Sacerdote, S.**
 June 3, 1910, [Convention date]. [Addition
 to 27,790/10.]

Set - pans. — A vessel 1, containing the food to be heated, telescopes into an outer chamber 2 and is adapted, when partially raised, to be supported by hinged arms 10. The base of the chamber 2 is formed as a fire grate and, when removed from the non-conducting box 3, is supported on adjustable feet 9.

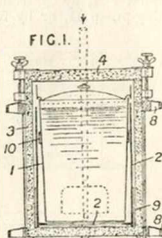

8918. **Wehrle, O.** April 14, 1910, [Convention date].

Set - pans. — In steam-heated brewers' coppers &c. having a downwardly-sloping inner bottom *a*, the under surface *b* of the steam-chamber *c* is domed in the opposite direction, so that condensation water is led away from the steam inlet *f* and the heating-surface.

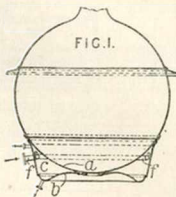

8808. **Alt, K.** April 8.

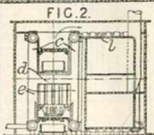
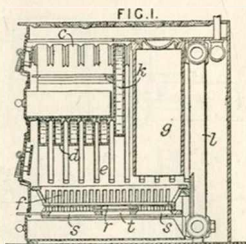
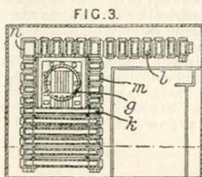

Kitchen - range and like boilers. — A cooking and water-heating stove has a boiler formed of H-shaped elements *c, d, e* enclosing separate fire-places, and vertical elements *l, m, n* surrounding the feed-hopper *g* of the lower fire-place and extending along the back of the oven. A transverse water chamber *k* separates the upper fire-place from the feed-hopper of the lower.

8925. **Coalbrookdale Co., and Malcolm, W. S.** April 10.

Kitchen - range and like boilers, which form the back and one or both sides of the fire-space, are formed so that substantially the whole of the combustion products pass beneath them, without heating the hot-plate, on their way to the ovens or chimney. Fig. 4 shows a boiler having a back portion 1 of the full depth of the grate, and a side wing 4, of less depth, beneath which the combustion products pass. The faces of the boiler which limit the fire-space are preferably curved or sloped forwards, as shown; the top faces 15, 16 may also slope towards the fire-space, so as to leave a small space beneath the hot plate of the range.

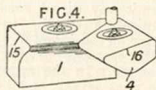

9277. **Siller & Jamart.** July 28, 1910, [Convention date]. *Drawings to Specification.*

Feed-water, heating. — To avoid the disadvantages attaching to the use of cast-iron or wrought-iron alone in the construction of feed-water-heaters, the feed-water is first passed into a system of cast-iron pipes and then into wrought-iron pipes nearer to the furnace. The furnace gases and the water pass in opposite directions.

9610. **Chadborn, F. C.** April 20.

Washing-boilers. — A boiler 13 on a pedestal 14 is heated by a special burner 1 supported within an enclosing-jacket 16, carried by a flange 15 on the boiler.

(For Figure see next page.)

9610.

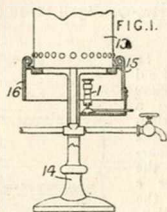

9657. Anderson, J., and Hippus, J.
April 20.

Digesters.—A digester for the continuous production of fuel from peat is provided with mechanical discharging-valves which do not permit any direct communication of the interior of the digester with the atmosphere, and with separate means for maintaining the pressure. In the apparatus shown in Fig. 1, the peat is supplied by a pump H through a recuperator P, which is heated by the outgoing peat, to the digester K, from which it is

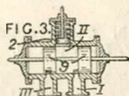

delivered through the discharging-device M, to the recuperator P. The pressure in the digester may be maintained by means of an accumulator A, by controlling the action of the charging-pump H, or by forcing in air or gas.

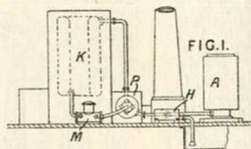

One form of the discharging-devices described comprises, as shown in Fig. 3, a chamber II which is alternately placed in communication with the pipe I connected to the digester and with the outlet pipe III by means of reciprocating pistons 9. A piston 2 acted on by a spring or the like assists in discharging the material from the chamber II. In modifications described, cylindrical or disk valves are used. In a further modification, the energy in the fluid mass leaving the digester is utilized by employing an hydraulic engine as the discharging-device; the power developed may be used in driving the charging-pump H. Specifications 10,834/03 and 20,420/03, [Class 50, Fuel, Manufacture of], are referred to.

10,020. Sauer, A. April 25.

Heating water.—The waste gases from a boiler furnace, blast furnace, coke-oven, or the like, are drawn through a multitubular water-heater D by an ejector G comprising a conical casing G¹ having at its lower end an annular steam channel G², from which lead spiral discharge conduits G³. After leaving the heater, the gases are washed in a tank K and collected for further use in a gasholder K¹. The supply of steam to the ejector may be regulated according to the pressure in the boiler by a diaphragm-operated valve H¹. In a modified form of apparatus, Fig. 6, the steam for the ejector is supplied from a steam-generator O⁶ mounted on top of the heater O⁴. A combustion chamber R is formed between the heater and the generator, and air is supplied through a valve R¹ to ignite the gases. The suction chamber may be of cylindrical instead of conical form. The apparatus used is of the same type as that described in Specifications 6296/11 and 6297/11.

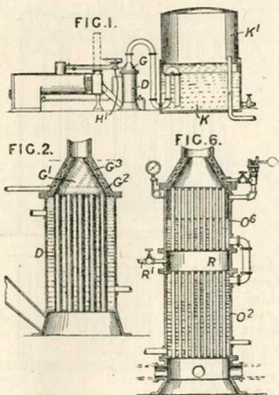

10,021. Sauer, A. April 25.

Heating air.—In a suction device A in which a vortex blast caused by steam issuing from spiral passages B⁶, B⁷ creates a suction through pipes D and chambers B², B³, the incoming air is heated by steam passed through a pipe F.

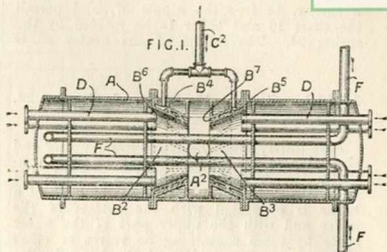

10,223. Still, W. J., and British Still Tube Co. Oct. 27.

Water-tube boilers.—Fig. 2 shows a part sectional plan view of a tubulous water-heater, the edges e of the vertical heat-conducting plates being flanged to form the outer casing. The tubes a are spaced nearer together the nearer they are to the source of heat.

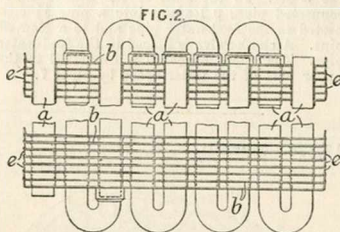

10,766. Hessdörfer, G. May 3.

Portable heaters for liquids.

—Apparatus for making coffee comprises a boiler 1, 2 which is suspended in a frame and rotated by a spring 24 when the water boils, coffee being made in the upper part 1 and the heater 36 then extinguished. The lower part of the boiler has a chamber 5 to which water passes through a valve 10. The parts 1, 2 are connected by a handle 4 and by means of a trunnion 14, which engages a slot 16, Fig. 4, in a shaft 15 having a handle 23, Fig. 1, and mounted in a bush 22. The bush 22 is connected to the handle 23 by a spring 24 and has a slot 38 to receive a nipple 37 upon the shaft 15 and engaging a click 21. In operation, steam generated in the chamber 5 raises the piston 7 with which the chamber 5 is fitted. A lever 9 is thereby lifted and the lever 19 rocked so as to allow the click 21, under the action of

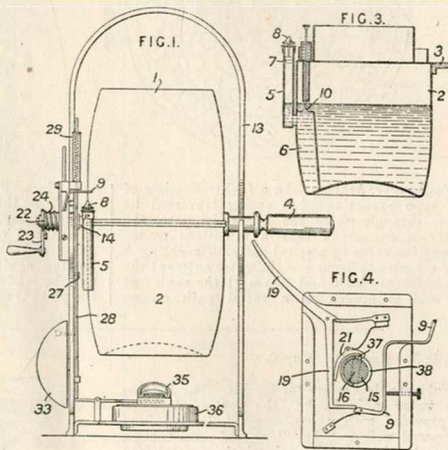

a spring, to free the nipple 37, and permit the shaft 15 and boiler to be rotated by the spring 24. The lid 35 of the heater 36 is

closed by a projection upon the part 1 which depresses a rod 28. The rod is returned by a spring 29 and one or more gongs 33 rung.

11,113. Green, F. W., and Slade, H.
May 8.

Feed-water, heating.—A feed-water heater and circulator of the type consisting of tubes connecting upper and lower headers and adapted to be placed in the downtake at the back of a boiler is connected with the bottom of the boiler and with the upper part of the water space by tubes containing no valves or other obstructions. The middle of the lower header 4 is connected by a pipe 8 to the bottom of the boiler. To the ends of the header 4 are connected pipes 9 leading into a pipe 11 connected to the feed-water pipe and to a blow-off pipe. A check-valve is placed in the feed-water pipe. The upper header 5 is connected to the upper part of the water space by pipes 7.

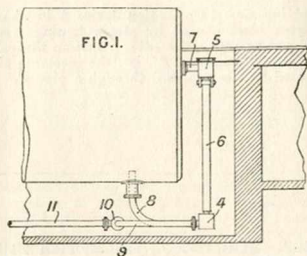

11,176. Burkill, J. E. May 9.

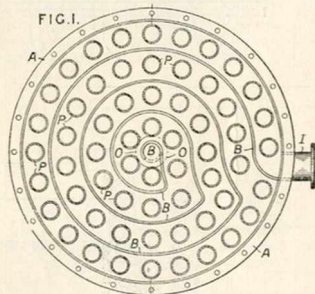

Feed-water, heating.—In a fuel-economizer of the type consisting of a casing traversed by tubes through which the flue gases pass, the water is caused to take a circuitous course among the tubes by a spiral baffle. The casing A is of cylindrical form, and the water enters at the circumference at I and leaves at the centre at O, and is guided in a spiral path among

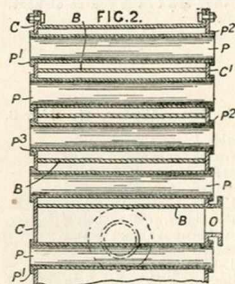

the pipes P by the baffle-plate B. The pipes P fit through holes in the end plates C, C' of the casing, and are held in place by nuts P² at the end remote from the furnace. At the other end they are formed with flanges P¹ bearing against the plate C. The flanges P¹ may be made conical as at P³ and the holes in the plate C countersunk to fit them.

11,253. Cox, J. May 9.

Submersible heaters for liquids. For heating the water in baths &c., the floating device a is provided with a gas-burner b located in a narrowed well or "keel" a¹ and cross-tubes c above the burner, through which a circulation is caused.

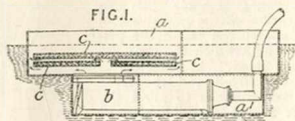

11,264. Cumming, D. B. May 10.

Feed-water, heating.

—Feed-water, after being filtered, falls through a series of perforated plates in contact with steam. The lowest plate I is perforated at the ends only so as to cause the water to take a longer course in contact with steam entering through the inlet H.

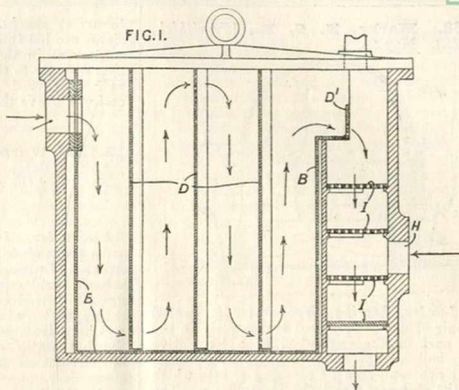
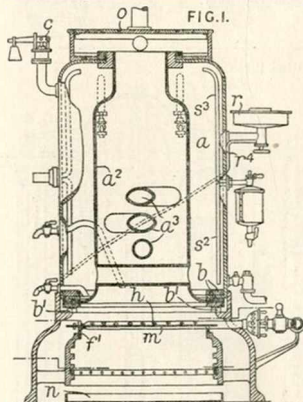

11,630. Reichert, A. May 14, 1910, [Convention date].

Vertical boilers.—A modification of the apparatus described in Specification 29,915/10, [Class 126, Stoves &c.], has a boiler traversed by a chimney a^2 with cross water-tubes a^3 ; at its upper end is a hot-plate a fitted with removable rings like those on a kitchen range. The parts a , a^2 are jointed by rings b and bolts b^1 .

12,447. Donald, H. E., and Donald, E. S. May 23.

Heating water; vertical boilers.—A boiler giving two distinct supplies of hot water, one

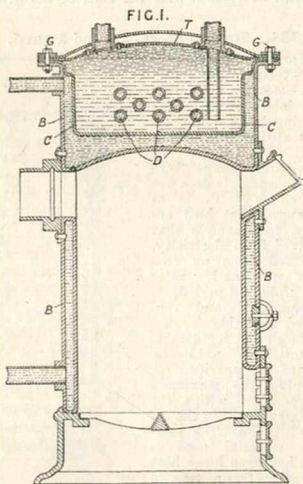
for domestic purposes and the other for heating buildings &c., consists of a primary boiler B of iron closed at the top by a secondary boiler C of copper, which together with its cover T is



secured upon the primary boiler by bolts G. The boiler C supplying the water for domestic purposes is heated by the water from the boiler B passing through inclined tubes D.

12,468. Marks, E. C. R., [Trevithick, F. H.]. May 23.

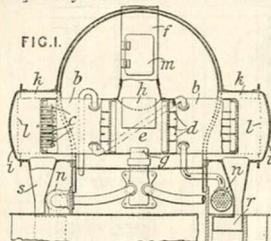

Feed-water, heating.—Feed-water is heated in a pair of drums arranged transversely in the lower part of the smoke-box of a locomotive or like boiler. The drums *b* containing smoke-tubes *c* are connected by a casing *e*, into which open the chimney *f* and the blast-pipe *g*. The drums are fitted with baffle plates *d*. The feed-water before passing into the drums may be heated in exhaust-steam heaters *n*. Doors *i* are provided on side extensions *k* of the smoke-box to afford access to the drums. Wire-gauze sieves *l* are placed over the ends of the drums

to arrest sparks. The ashes arrested by the sieves are led through chutes *s* into ash-boxes *r*. A door *m* in the chimney allows the gases to pass directly to the uptake. A petticoat *h* or a pair of curved guide-plates is placed in the casing *e* above the blast pipe.

12,535. Werner, T. May 25, 1910, [Convention date]. Void. [Published under Section 91 of the Act.]

Feed-water, heating.

—An economizer is constructed of wrought-iron tubes *a*, and cold feed-water is introduced into the apparatus at a point *e*, where it mixes with the hot water already in circulation in the economizer or with a part of it so as to minimize the "sweating" of the heated tubes. Hot feed-water is removed at *f*.

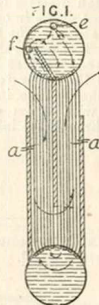

13,334. Harrison, A. F., and Peard, O. L. June 2.

Heating liquids.—A low-temperature thermal-storage apparatus for intermittently furnishing large quantities of heated water or other liquids in which the maximum temperature of the reservoir does not exceed 300° F. is so arranged that heat energy, for example that derived from electricity, received from an outside source at low rates for prolonged periods, is accumulated and rendered available for use in large and regulatable quantities, automatic means are provided for keeping the maximum temperature within the desired limits. The storage material used is one having a large heat capacity for a rise in temperature not greatly exceeding the temperature at which heat is required from the apparatus, for example, acetate of soda, suitable water solutions, or water alone. The means for

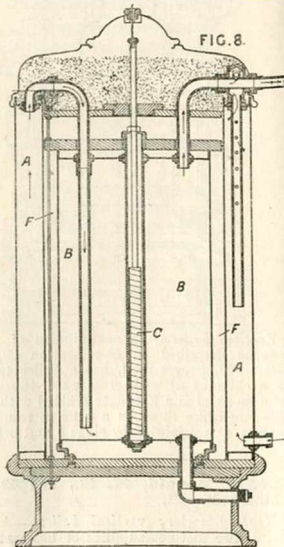
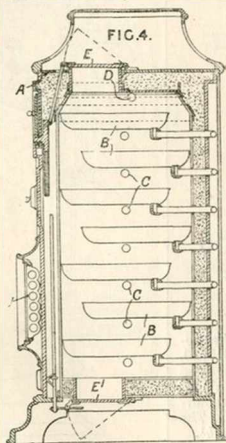

regulating the use of the apparatus consist of dampers or valves controlling the passage through the apparatus of the medium to be heated. The automatic means for regulating the temperature comprise thermostats which may operate either valves or switches controlling the supply of energy, or the dampers &c., allowing the heating effect to operate in part and thus increase the radiation losses. The whole apparatus is normally heat-insulated, and this insulation may be so proportioned that the heat losses through radiation on reaching a pre-determined temperature are sufficient to prevent a further rise. In this case no thermostatic device is necessary. Fig. 8 shows the application of the invention to a water-heater, the water itself in this instance being used as the storage medium. A tank A surrounds A tank B, which is directly heated by a heater C. An air space F serves as a partial insulation. The tank capacities are so proportioned that, when the water in the water-chamber has attained a certain temperature, the radiation losses from the external chamber will equal and balance the heat supplied. Or, the outer tank may be jacketed and thermostats used.

13,347. Roxburgh, A. E., and Scott, J. E. June 3.

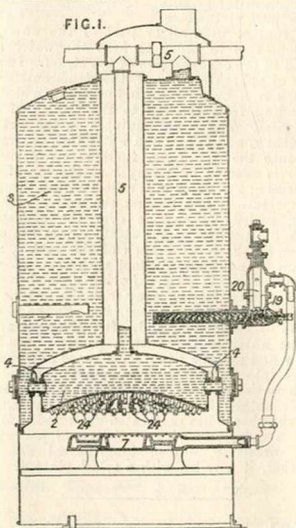

Vertical boilers; geysers.—A main heater 2 communicates with a circulating-vessel 3 at their uppermost and lower parts 5, 4, respectively, and the draw-off outlet for heated water

is situated where the upper means of communication opens into the circulating-chamber. Studs 24 assist the heating of the vessel 2. In a modification, the main heater and circulating-vessel are formed in one, and are separated by a removable partition having an upward tubular extension constituting the upper means of communication between the chambers. This partition may be double with heat-insulating means filling the space between the double walls. A thermostatic device comprises mercury 19 which, on expansion, obstructs the passage 20 for gas to the burner 7.

13,364. Hygienic Stove Co., and Greenwood, E. P. June 3.

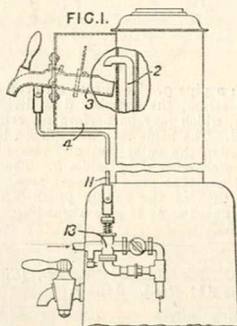

Water delivery.—Relates to devices to replace taps for drawing-off boiling water from hot-water boilers. The upwardly-extending outlet-pipe 2 of the boiler discharges over an opening in the upper part of a pivoted pipe 3. When the pipe 3 is in the position shown, water discharged into it runs back into a chamber 4, and thence into the boiler, but when it is tilted forward, the water runs out at the outer end. The pipe 3 may be connected by a rod 11 with a valve 13 controlling the supply of gas to the burners of the boiler, so that when water is being drawn off, an extra quantity of gas is supplied to the burners. The pipe 3, instead of discharging into the open, may discharge into a fixed spout. It may be pivoted so as to turn horizontally instead of vertically, or it may be fixed and the top of the pipe 2 pivoted so as to move horizontally.

13,391. Synoe, F. O., and Balchin, Schulz, & Co. June 3.

Washing-boilers, set-pans, and the like.—Jacketed vessels heated by low-pressure highly-superheated steam, and adapted for use in heating, boiling, melting, evaporating, or distilling,

comprise two similar pans *a, b* joined at their rims *c* so as to form a steam-chamber *d* round the inner pan. Superheated steam is admitted at the bottom by a nozzle *f*, and is exhausted

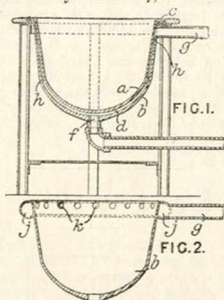

through a pipe *g*. To ensure an even distribution of steam, the chamber *d* is divided by a baffle *h*, which may be perforated, crimped, or serrated. The baffle may be replaced by a pipe *j* encircling the outer pan and communicating with the chamber *d* by inlets *k*. The chamber *d* is of constant cross-sectional area, approximately that of the supply pipe. Either pan may be fluted so as to give a whirling motion to the steam.

13,613. Derriman, W. H., [Siemens & Halske Akt.-Ges.]. June 7.

Heating air.—In a continuous process for heating and drying air, the heat of the subsequently regenerated sulphuric acid, used for drying, is employed for heating the air. The apparatus comprises a dryer *a*, a heat equalizer *b*, a sulphuric acid regenerator *c*, and a preliminary heater *d* for acid to be regenerated. Air is dried in the dryer *a* by contact with sulphuric acid supplied at *n*, and passes through the chamber *b*, where it is heated by hot acid in the pipe *i* coming from the regenerator *c*. Thence the air passes to the trunk *h*.

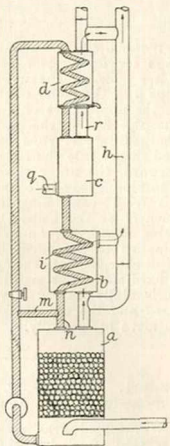

The weakened acid is pumped partly back to the dryer and partly to the regenerator, wherein it flows over heated plates, air supplied at *q* passing over it at the same time. This air escaping at *r* serves to heat the weakened acid preliminarily in the chamber *d*, and then passes also to the trunk *h*.

13,848. Brown, E. Hall. June 10.

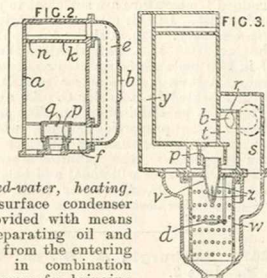

Feed-water, heating.

—A surface condenser is provided with means for separating oil and water from the entering steam in combination with means for bringing all or part of the steam into contact with all or part of the water of condensation in order to heat the water and to aid in the condensation of the steam. In one form of apparatus, Fig. 2, the steam enters the condenser *a* by an inlet *b* formed in a duct *e* extending from the top to the bottom of the condenser. The steam impinges on the wall of the duct *e*, and the oil and water thus separated fall into the well *f*. A further separation of water is effected by a tray *k* at the top of the condenser; the water thus collected falls through an aperture *n* and reaches the well *f* without being cooled by passage over the condenser tubes. A portion of the steam enters the condenser by the lower branch of the duct *e*, and is thus brought into contact with the water of condensation. A weir *p* having a hood *q* prevents oil from flowing away with the water. In another form of apparatus, Fig. 3, the steam enters by an inlet *b*, and, after the separation of the water in the duct *t*, passes through a port *r* and passage *s* to a chamber *w* in which it comes into contact with a spray of water of condensation derived from the weir *p*; the steam finally enters the condenser *a* by a passage *y*. The chamber *w* has perforated walls and is fitted with a spraying-device consisting of a convergent nozzle *v* having longitudinal slits *z*, together, it may be, with a splash-plate *d*.

13,923. Harbinger, W. June 12.

Feed-water, heating.—In the smoke-box of a boiler is placed an arrangement of tubes, partly below the boiler water-level, and provided with

connexions such that it can be used as a fuel-economizer or as an extension of the boiler. The apparatus is analogous to that described

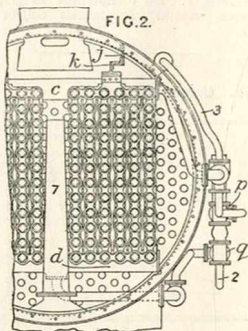

in Specification 27,760/08. It is out of the path of the exhaust steam, and can be slidden out of the smoke-box for repairs &c. The tubes are connected to top and bottom headers *c*, *d*, and are arranged in two batches on each side of the blast-pipe 7. They are suspended by brackets *k* from angle-irons *j* in the smoke-box along which they can be slidden out. To use the apparatus as an economizer, the lower header *d* is connected to the feed-pipe 2 through the valve *q*, and the header *c* is connected to the water space of the boiler through the valve *p*.

13,971. Owen, W. G., and Oakley, N. June 12.

Heating liquids.—Starch is boiled by steam admitted through a pipe *p* and perforated coil *q* arranged round the edge of the bottom of a vessel *a*, in which are stirrers *m*, *n*.

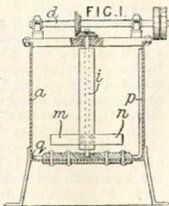

14,468. Fletcher, J. E. June 19.

Feed-water, heating.—Feed-water is heated by direct contact with steam in an apparatus like an ejector-condenser, which is placed inside the boiler and discharges in the direction of the boiler convection currents. The feed-water pipe 3, Fig. 1, opens into a series of nozzles 6, Fig. 4,

in a casing 2, which is in communication with the boiler steam-space through a pipe 4. The outlet pipe 5 is curved in the direction of the

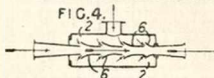
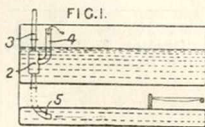

convection currents. The pipe 4 may be connected to a separate source of steam supply, and the steam may be superheated.

15,087. Perry, W. P. June 28.

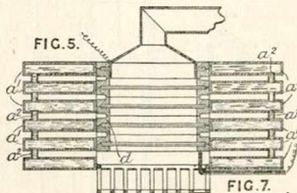

Heating water.—In a combined boiler and thermo-electric generator having ring-shaped thermo-electric elements with the hot junctions projecting into a flue, and the cold junctions in contact with, or forming part of, the boiler, the elements are arranged so that the hot gases may enter recesses between the rings. In the arrangement shown in Fig. 5, the boiler is in ring-shaped sections *a*¹ insulated from each other, the sections being connected together by means of india-rubber tubes *a*². In this case a single cold junction of the thermo-electric elements *d* is in contact with the wall of each section of the boiler. Otherwise the boiler may be a hollow cylinder, the cold junctions of the elements being insulated by enamel or mica from the wall of the boiler. A boiler may be provided with several flues each fitted with rings. According to the Provisional Specification, elements may project radially. In the arrangement shown in Fig. 7, disk-shaped elements *c*¹, *d*¹ of copper and german silver are

arranged about a water tube a^3 , or the tube may be omitted, the elements being of the shape shown in Fig. 5, and themselves forming a water tube.

15,229. **Carlier, L. Savary**-. June 29.
[Addition to 30,378/10.]

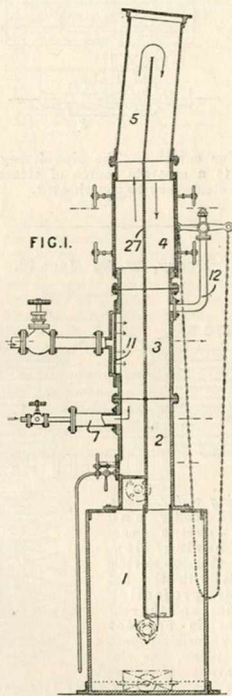

Feed-water, heating.—Water, entering through perforations in a plate 11, is carried

in the form of drops by an upward blast of steam from a port 7 up and down a column composed of superposed sections 2, 3, 4, each divided by a web 27, surmounted by a cap 5, into a tank 1. An escape-pipe 12 is provided for excess steam. Impurities collect in the tank 1.

15,488. **Carr, S.** July 3.

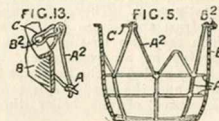
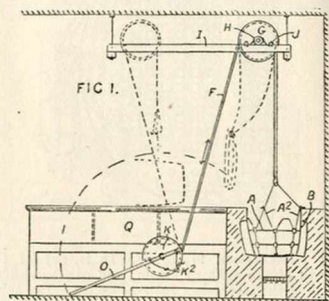

Washing-boilers.—An apparatus for lifting, conveying, and tipping laundry loads carried in baskets comprises a basket A adapted to be placed in a copper B and connected by hooks to a rope F passing over a travelling sheave G, which can be run along rails I to bring the basket over the tubs Q. The basket is constructed of wire and hemp &c. with projections at the corners of the meshes so as to ensure circulation spaces between the basket and the copper. Loops A^2 to which the suspension hooks are attached are provided with shackles C adapted to engage buttons B^2 , Fig. 13, to hold the basket in place in the copper. One of the loops A^2 is hinged to allow the basket to be tipped as shown in dotted lines in Fig. 1.

15,598. **Sanderson, H.** July 5.

Feed-water, heating.—The feed-water for a steam-generator S heated by the combustion of gas in tubes B filled with refractory material, is heated and the gas supply to the generator is cooled, in a tubulous heat-exchanger T between the gas-producer P and the generator. The

feed-water is further heated in a casing F arranged around the gas-producer and traversed by radial tubes R, which convey the gas from the producer to an annular chamber G.

(For Figure see next page.)

15,598.

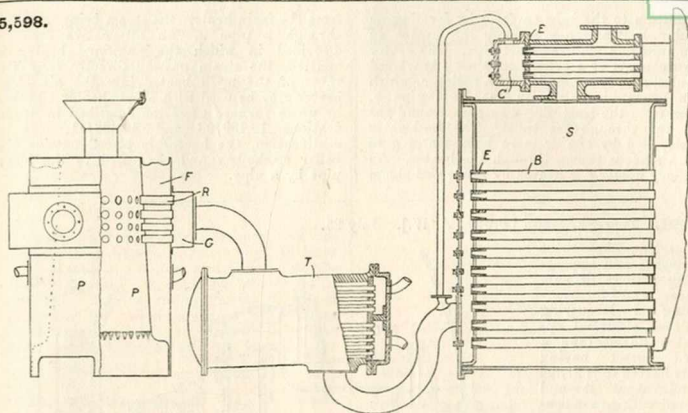

15,664. Dardenne, L. M. July 5.

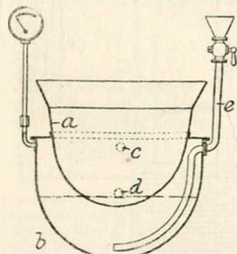

Set-pans.—Chocolate is cooked with milk or water in a pan *a* heated by a water-jacket *b* having a valved feed-pipe *e* and discharge cocks *c*, *d* for steam and water respectively.

16,032. Carling, W. T. July 11.

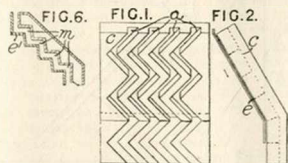

Kitchen-range and like boilers.—A boiler *c* for use with an open grate has zigzag channels *a*

formed in the front face, so that, when used with a flue plate *e* as described in Specification 372/10, the gases pass away through a series of separate flues. The zigzag channels may be replaced by communicating vertical channels interrupted by projections on the boiler; or, as shown in Fig. 6, horizontal channels *m* may be used, in which case, the flue plate *e'* is correspondingly shaped. When a flue-plate is not used, the channels are formed in the back of the boiler.

16,444. Marks, E. C. R., [Trevithick, F. H.]. July 17.

FIG. 2.

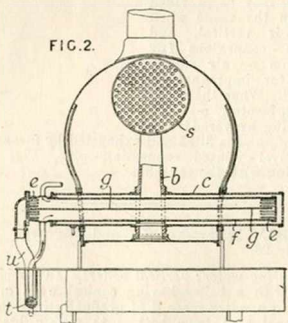

Feed-water, heating.—In a tubular feed-heater for locomotive and like boilers, the outside surface of the heater is used as a heating-surface



in addition to the tube surfaces by forming an annular heating-space around the heater in communication with the blast-pipe. The heater shown consists of a cylindrical shell *f* traversed by tubes *e* and surrounded by a casing *c*, which is in communication with the blast pipe *b*. Steam from the blast-pipe may pass around the shell and through the tubes. The feed-water is compelled by one or more baffle-plates *g* to take a sinuous course through the heater. An auxiliary heater *t* is heated by condensed steam

from the main heater, the steam being supplied through a pipe *u*. An alternative form is described in which the auxiliary heater is omitted, the steam passing directly from the tubes of the main heater into the air. The heater may be used with a feed-heater *s* heated by waste furnace gases, as described in Specifications 19,139/08 and 12,468/11. In a modification, the heater is placed outside the boiler smoke-box and connected to the blast-pipe by a pipe.

16,991. Dryers, Ltd., [Brown, A. W.]. July 25.

Digesters.—Apparatus for drying and impregnating articles or substances and for varnishing or lacquering insulated electrical apparatus comprises a closed vessel having steam-heated coils 21, 22 wound about it and covered with a non-conducting covering 24, between which and the coils a casing 23 may be interposed. Around the mouth of the vessel and around its cover, heavy continuous rings 3 are set. The cover is secured to the vessel by T-sectional clamps, shown in Fig. 5, in which the hinges are made to allow free play, and the strain is taken at a point 8. The cover of the vessel may be carried by a davit or crane. A removable lining may be provided within the vessel when this is vertical, and pipe-connexions for vacuum or air supply and for impregnating-liquid. When the vessel is horizontal, a truck carrying a covered trunk is used, and is filled and exhausted by means of a swivel-jointed connecting-pipe, Fig. 11, opening with the tank 37.

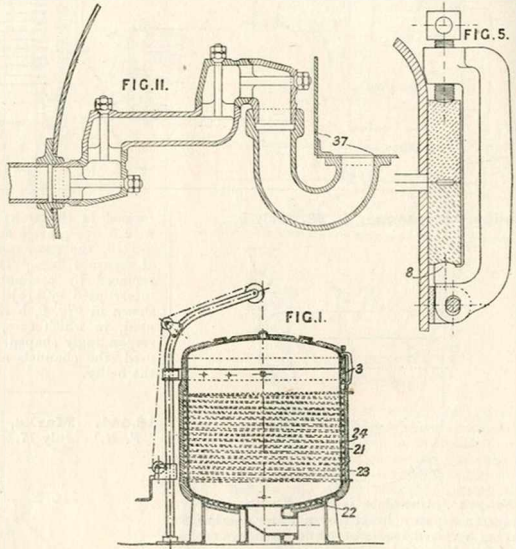

17,083. Darrah, E., and Brown, W. July 26.

Heating water; vertical boilers.—In combination with a boiler having conical walls *a*, *b*, leaving a water-space *d* of gradually increasing sectional area from bottom to top, a branch pipe *j'* leads from the flow-pipe *j* to above the level of the cold-water supply and cistern from a view to increase the circulation of water from the boiler.

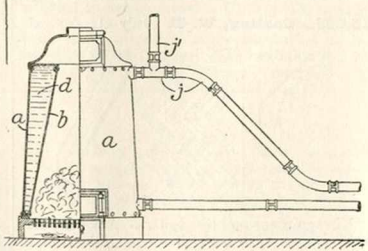

17,572. Arlow, M. Aug. 2.

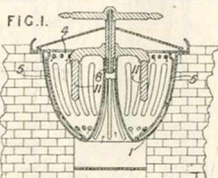

Washing-boilers.—Within a copper 1 of the shape shown, a liner 4 is fitted so as to leave a narrow space 5 to effect a circulation of the contained liquid. A rotatable stirrer 11 is mounted on the upstanding portion 8. In a modification for use in a copper of ordinary form, the upstanding part 8 fitted with the stirrer is made integral with the liner 4.

17,638. Morison, D. E. Aug. 3. [Addition to 26,482/10.]

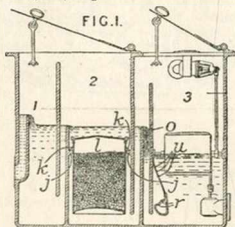

Feed-water, heating.—Relates to the construction and arrangement of filters and steam heating-nozzles in the apparatus for heating and filtering boiler feed-water described in the parent Specification. The apparatus consists of an oil-separating chamber 1, a filtering-chamber 2, and a heating-chamber 3 from which the water escapes by a float-controlled valve. The filters consist of bucket-shaped vessels *l* with perforated tops and bottoms and containing filtering-material. The vessels *l* are provided with external flanges *k*, whereby they are suspended in holes in an horizontal partition *j* in the filtering-chamber. Special filters higher than the others may be provided for use with especially impure water. The chambers 1, 2 may be divided by a longitudinal partition so that one set of filters may be used while the other is being cleaned &c. The water passes to the heating-chamber 3 through a strainer *o* which separates loose filtering-material. The steam heating-nozzle *r* consists of a perforated pipe similar to that described in the parent Specification, from which an inclined perforated plate *u* extends upwards to the wall of the chamber 3. A second nozzle for impure steam may be placed in the chamber 1.

17,671. Simon & Sons, R., and Simon, W. G. Aug. 3.

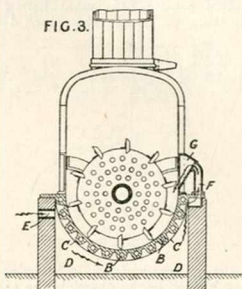

Washing-boilers, set-pans, &c.—In drying-apparatus of the kind shown, the trough is provided on the outer periphery with a series of longitudinal tubes B, opening into one or more annular chambers C through which steam is admitted. The trough may be enclosed in a chamber D of brickwork, so that air entering from outside through the conduit E, and being warmed by the tubes B may pass through conduits F, G into the trough.

18,359. Menard, P. Sept. 3, 1910, [Convention date].

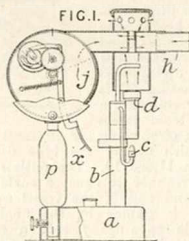

Heating air.—Air, driven by a fan *j* operated as required by gearing from a lever *x*, passes through a tube *h*, and is heated therein by the flame from a spirit lamp *a, b, c, d*. The whole apparatus is portable by a handle *p*.

19,291. Waller, W. W. Sept. 3, 1910, [Convention date].

Heating air &c.—Air is forced by a fan 3 through a chamber 1, containing a tubular heater, to a casing 7, whence it is delivered by

the outlet 8. The tubular heater, shown in Figs. 3 and 4, consists of upper and lower headers 6, 5 connected by jacketed air-pipes 4. The headers consist of several hollow inter-communicating portions. The pipes 4 extend

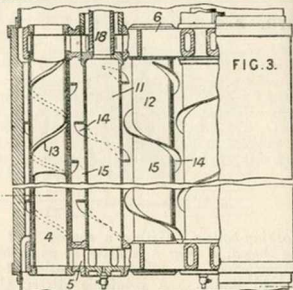
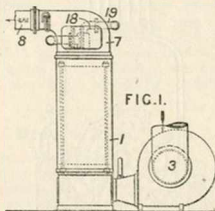

through the headers and a fluid introduced into the upper header passes through the space between the tubes 4 and their jackets 12 to the lower headers, whence it returns by single large pipes 11 to branches 18 leading to the outlet main 19. The air passes upwards through the pipes 4 and through the space 15 between the jackets 12 and the pipes 11. The pipes 11 and jackets 12 are provided with external helical baffles 14, and similar baffles 13 are placed in the spaces between the pipes 4 and 12. The side of the chamber 1 is hollowed out to direct air against the jackets 12.

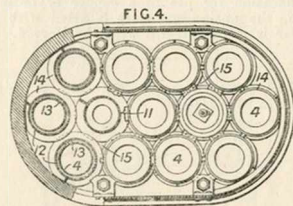

19,564. Morison, D. B. Sept. 2.

Heating water.—In a steam-regenerative accumulator or direct-contact water-heater, the incoming steam is caused to effect a surface flow in a desired direction so that the floating oil is constantly driven into a receiver. Steam passes through the circulating tubes *d* which are of the type described in Specification 11,690/10. The outlets from the tubes are arranged to cause a surface flow to the right-hand end of the vessel so that the floating oil is guided by the angle plate *e* through side openings *f* into a receiver *r*, which is fitted with a scumming-device *g*. Modifications are described in which the plate *e* has a central opening which may be provided with a valve, or an inclined sill to prevent return flow from the receiver. The depth of the surface flow may be limited by baffles, and the vessel may be of circular form. Steam supplied to the nozzle 2 passes through the outlets 3, producing an upward circulation in the tube 4. The outlet 5 at the top of the tube is arranged on one side so that the circulating water is discharged in one direction. Steam may be discharged through openings 6 in the central pipe 1 to assist the surface flow.

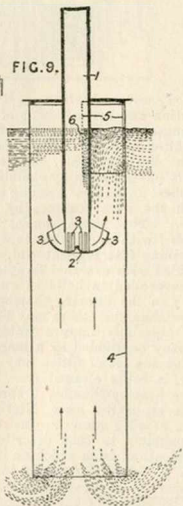
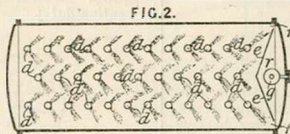

20,252. Lajoie, J. P. Sept. 13, 1910, [Convention date].

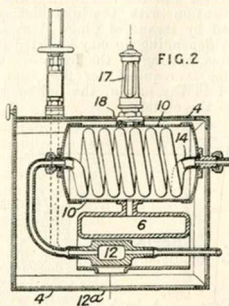

Heating gases.—Carbon dioxide or other compressed gas to be used for driving motors is heated and expanded to such a degree that after further expansion in the motor it has about the temperature of the atmosphere or other desired temperature. The gas is heated in a chamber 12 by a burner and allowed to expand in a coil 14. The coil 14 is surrounded by a casing 10 containing water and communicating with a crescent-shaped chamber 6 forming part of a cylinder containing the chamber 12. The whole apparatus is enclosed in a casing 4 provided with an opening 12^a for the burner which heats the chamber 12 and an opening 18 for the escape of combustion products. A gauge 17 attached to the chamber 10 protrudes through the opening 18.

20,461. Schumacher, R. Sept. 15.

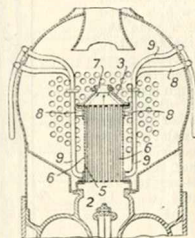

Feed-water, heating.—A feedwater-heater arranged in the smoke-box of a locomotive boiler directly above the exhaust-steam chamber consists of a casing 5 traversed by straight vertical tubes 6, through which the exhaust steam from the chamber 2 passes to the tapering cover 3 terminating in the mouth 7 of the blast-pipe.

The mouth is made adjustable by means of interchangeable insertion-pieces. Water is admitted to the heater by the pipes 8 and delivered through pipes 9, thus travelling in the opposite direction to the exhaust steam.

20,807. Soc. Française de Chaleur et Lumière. Jan. 20, [Convention date].

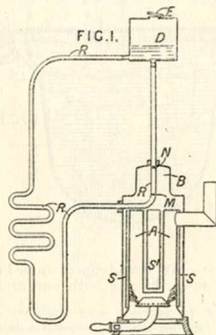

Vertical boilers.—The boiler A of a hot-water heating-system is provided with an extension B and is fitted internally with open-ended tubes S, S' to facilitate the circulation of the water. The return pipe R of the system enters the upper part of the boiler, traverses the extension B, and then passes upwards to the expansion tank D. Within the extension B, the pipe R is formed with lower and upper ports M, N.

21,107. Smith, T., and O'Brien, A. H. Sept. 25.

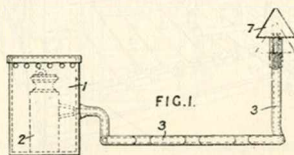

Submersible heaters for liquids.—An apparatus to be submerged in a bath or other vessel of water to be heated is adapted also for use as a stove. A casing 1 contains a spirit vapour lamp 2 of the blast or blow-lamp type, and leading therefrom a tube 3 which may be serpentine, having at its outer unsubmerged end a regulating-device such as an adjustable cap



or cover 7. This cap may also serve to deflect the hot escaping gases on to the surface of the water.

21,481. Darby, E., [trading as Patent Tip-up Bath Co.]. Sept. 29.

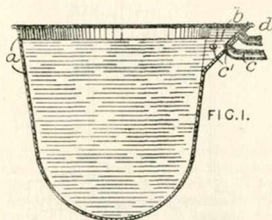

Set-pans.—An open-topped water-heater *a* is provided near the rim with one or more hot-

water outlet pipes *c* and with an overflow pipe *d* at a slightly higher level. These pipes may open into a recess *b* or the like in the side wall, and communication with the distributing-pipes *c* is opened by means of plugs *c'* as shown, or taps. A depending lip may be fitted to prevent scum from passing to the pipes *c*. When the hot water is required for use, cold water is poured into the pan *a*, the lighter hot water rising to the outlets.

21,550. Shorland, F. H. Sept. 30.

Kitchen-range and like boilers.—A back boiler *b* for a fire-place has a vertical flue *c* and an overhanging incline *b'* as shown.

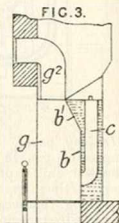

22,425. Howes, T. A., and Bannerman, G. Oct. 11.

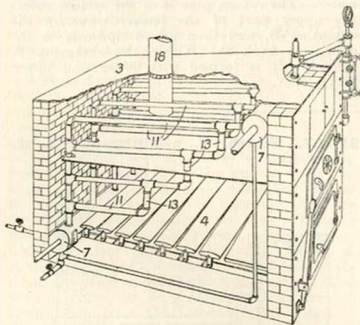

Water-tube boilers.—A water-heater consists of an inverted stair-like range of tubes 11, 13, &c. connected to headers 7 and heated by a fire on shaking grate bars 4. A baffle-plate 15 is fitted so as almost to touch the walls of the casing. The smoke-stack 18 extends a short distance downwards through the sheet-metal top 3.

22,570. Prior, J. D. Oct. 13.

Heating water.—In the storage tank *a* of a hot-water supply system, an extension *b* is fitted to the outflow *c* to the boiler, preferably in two or more telescopic parts *b, b'*, water passing thereto through separate slots *d², d, d¹* successively larger, or through a continuous slot preferably increasing in area towards the top. In place of a separate tube *b*, a channel may be formed in the side of the vessel.

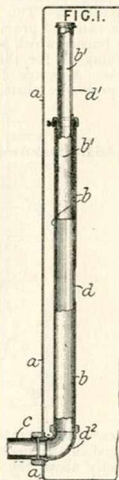

22,588. Morison, D. B. Oct. 13. [Cognate Application, 3785/12.]

Feed-water, heating.—

Apparatus for using exhaust steam, as from auxiliary machinery, for heating feed-water is provided with means for separating oil &c. from the steam, and with devices whereby excess of steam escapes to the atmosphere or to a condenser. The exhaust steam passes by pipes *b* to a chamber *a* in which is an inclined perforated plate *c* with ridges surrounding the perforations. Below the plate *c* are rows of channels *f* in a staggered arrangement as shown in Fig. 4. The plate *c* and channels *f* slope downwards to a chamber *e*, at the bottom of which is a trap *l* from which water is removed at the bottom and oil at the top. From the chamber *a*, the cleansed steam passes by an opening *t* to the feed-heater. With the chamber *a* communicates a chamber *w*, Fig. 3, communicating through openings controlled by valves 3, 4 with a condenser and by openings controlled by valves 5, 6 with the atmosphere. The valves 3, 6 are controlled by hand and the valves 4, 5 by springs. The valve

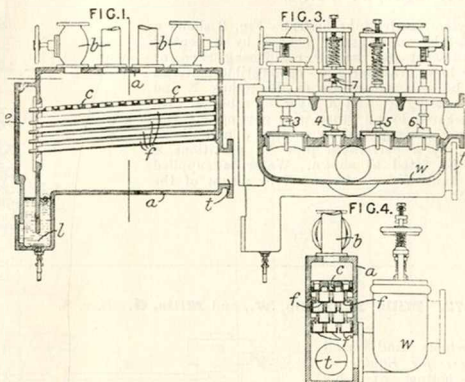

4 can be prevented from opening by a nut 7. Engines which must not exhaust against a back-pressure may exhaust through a second separator to the chamber into which the valves 3, 4 open. In this case the valves 3, 6 may be replaced by a single spring-controlled valve which can be held open.

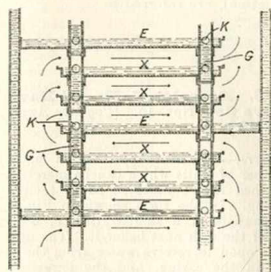
23,062. Smith, A. E. H., and Smith, C. H. Oct. 19. [Addition to 26,893/10.]

Geysers.—In the flue space between the trays *E*, additional trays *X* are placed to assist the heating effect. These trays are mounted and connected by similar short tubes *G* having perforations *K*.

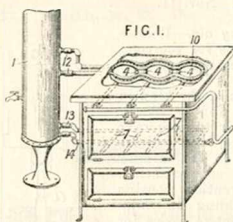
24,125. Nichols, C. Oct. 31.

Water-tube boilers.—A water-heating fitting for gas stoves comprises a boiler or container 1 connected by right and left handed screwed sleeves 12, 13 to water-heating pipes 10, 14 arranged over the hot-plate burners 4 and the oven and grilling-burners 7. The pipes 10 are arranged so as to pass on both sides of the rows of the flame jets from the burners 4, as shown.

24,397. **Fyfe, P.** Nov. 3.

Geysers; water-tube boilers.—Fig. 9 shows a coiled-tube water-heater heated by a central incandescent gas burner comprising sand or other loose granular non-combustible material held between wire-gauze or like fabric E and wire netting T, and a layer of asbestos wool &c. secured by an outer wire netting P. Gas and air are supplied by a pipe J and distributed by a perforated pipe Y; partitions Z may be fitted as shown. Water is supplied by a tank W and drawn off by means of the tap X.

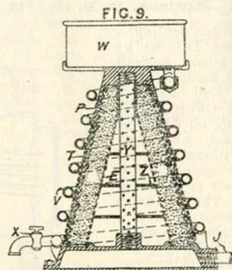

24,872. **Mills, D., Mills, W., and Mills, G.** Nov. 8.

Portable and small heaters for liquids.—The bottom of the boiler A has a rim through apertures in which asbestos fibres are threaded, and a vertical tube, with a closed upper end, rising centrally into the boiler.

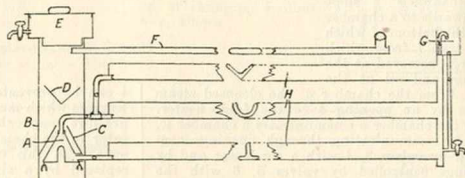

25,144. **Stone & Co., J., and Darker, A. H.** Nov. 11.

Heating air.—Relates to systems for the combined heating and ventilation of railway carriages of the kind in which a fan or blower causes air to pass over the heater and delivers the air to the interior of the compartments. The invention consists in providing an automatic control device for the fan motors comprising a pressure-responsive device which operates the motor only when steam is supplied to the heating devices. The device consists of a steam cylinder *a* connected up to a branch steam-pipe at *h*. A piston working in the cylinder under the control of a spring *f* is connected up by a piston-rod *d* with a switch lever or tumbler for the motor contained in

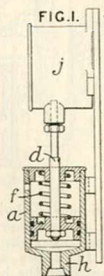

a case *j*. In a modification, a second cylinder is provided for the spring to work in. Specifications 22,452/05 and 17,537/10, [Class 137, Ventilation], are referred to.

25,476. **Barralet, J. H., and Davis Gas Stove Co.** Nov. 15. [Cognate Application, 1267/12.]

Geysers.—The heating-surface is made up of a number of units which can be merely pressed or pushed into contact so as to facilitate assembling. In the form shown in Fig. 1, each unit consists of a shallow dish *c*, *d* and the cover of the dish next below it. The uppermost dish is open to receive water from the annular space in the casing, and the lowermost communicates with the outlet. The dishes and covers are shown as alternately circular and annular in plan but they may be of other shapes so as to cause the hot gases to pass through a sinuous course.

(For Figure see next page.)

25,476.

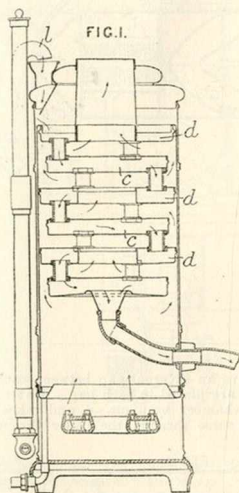

26,340. Lomschakow, A. Nov. 24.

Feed-water, heating.—

The superposed chambers 3, 4 of the distributing-header 1 are divided transversely into compartments which communicate either with the ribbed or smooth outer tubes 10 or the inner circulating-tubes 16 through ports 7, 8, 14, 15. The heads 9 of the tubes 10 are secured to the header 1 in the manner shown, or long bolts are passed right through the heads or through lugs at their sides. The inner tubes 16 are provided with a lateral extension which is forced against the ports by wedges 17. The ribbed portions of the tubes 10 may be made separately and welded to the smooth portions.

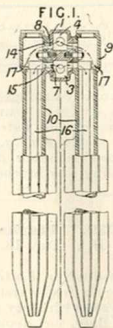

27,332. Mann, J. Dec. 6.

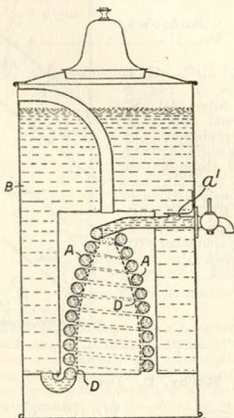

Water-tube boilers.—Fitting closely within the circulating coil A is an ordinary incandescent mantle D or other hollow shell of refractory material heated by a gas burner. A non-return valve a' , at the upper junction with the container B for the water &c. to be heated, ensures that the liquid drawn off should pass through the coil.

27,431. Smith, R. T. Dec. 7.

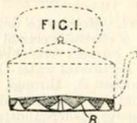

Washing-boilers.—Coppers and other vessels are provided with corrugated bottoms B, formed by the method described in Specification 26,646/09, [Class 83 (iv), Metals, Working], according to which the disks are formed from cylinders or truncated cones by means of dies. The central opening is closed by a cup-shaped piece, which may have holes provided in it.

27,778. Andrews, E. I. Dec. 11.

Heating air.—Air is drawn by a fan *S* through filters *G*³, *R*⁴ and around baffles *R*, heated preferably by electricity. Moisture passes off through perforations *R*², *R*⁴, and the air is driven through a funnel *G*⁴, a filter *G*⁵, an ozonizing-chamber *T*, a cooled chamber *G*⁶, and a screen *G*⁷.

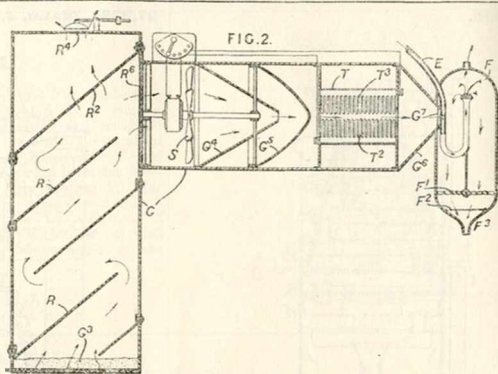

27,937. Kirby, C. Dec. 12.

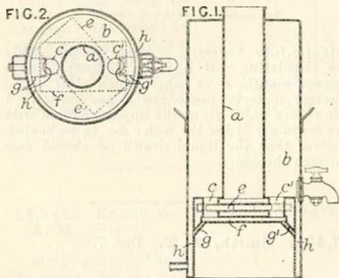

Vertical boilers.—Relates to devices for heating water with a central vertical flue, between which and the burners &c. are arranged a number of thin horizontal water-chambers. The main water-chamber *b*, through which passes the flue *a*, is continued downwards as a narrow annular water space *h* surrounding the burners. The thin water-chambers *e*, *f* are rectangular and arranged at an angle to one another as shown in Fig. 2. Vertical pipes *c*, *c*¹ pass from the chamber *b* to the chamber *f* and communicate with the chamber *e* over half their circumference, as shown. The chamber *f* communicates with the water space *h* by flat inclined pipes *g*, *g*¹.

28,010. Yates, H. J. Dec. 13.

Vertical boilers.—A boiler comprises a principal chamber *d* connected to superposed communicating chambers *d* which are formed so

as to leave an external gap between each pair. Baffles *f* are placed in each gap. Water enters the top chamber by a pipe *h* and takes a circuitous course through the boiler through the

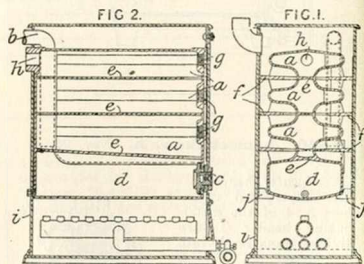

alternately-arranged apertures in the dividing-webs *e*, finally leaving through a pipe *b*; the course of the water may be reversed. Clean-out openings *c*, *g* are provided at the front of the chambers *a*, *d* which are supported within a casing *i* by brackets *j*.

28,019. Marks, E. C. R. [Trevithick, F. H.]. Dec. 13.

Feed-water, heating.—In a locomotive or like boiler, a feed-water heater and, if desired, the uptake or chimney are carried upon the smoke-box door, or upon a hinged portion of the smoke-box. The whole of the exhaust steam passes through exhaust-steam feed-heaters before entering the blast-pipe. Water is conveyed to the heater *d* carried by a hinged