

Backer

BACKER ELEMENTS

The Backer Electric Company are specialist manufacturers of mineral insulated tubular sheathed heating elements, and have at your disposal two quite independent processes, which together form the largest specialist production plant in Europe.

The *Backer powder filling process* is generally used for the economical and quick production of bulk and repetitive items, such as electric cooker heater components, washing machine, iron and kettle elements, and produces an element with circular cross section.

The *Backer conversion process* is an ideal means of producing the 'tailor made' small batch industrial requirement, and produces an element having a non circular section, except at the extreme ends.

A Backer element, produced by either process, can be sheathed in any of nine stock metals, available in a range of sizes and lengths up to 112" overall for the conversion process and 170" for the powder filled process. The surface rating is designed to suit the working conditions and if used in accordance with design recommendations carries a twelve month guarantee, for faulty workmanship and materials.

The Company specialises in meeting the needs of domestic appliance manufacturers, industrial heating engineers, and the heavy duty and domestic electric cooking industries.

An experienced technical design and engineering staff are ready to advise and help with any electrical heating problem, which should be forwarded in the form of an enquiry giving fullest information possible, to Head Office and Works at Rotherham, where it will receive both prompt and careful consideration.

Mineral insulated tubular sheathed heating elements

Most people are familiar with the open spiral heater coil used extensively in the past for electric fires, which, because it was 'live' required to be mounted on insulating formers and be protected by a guard.

Due to the difficulty of insulating the live coil, the application of this type of heater to industry was limited until, in 1900, our founder Mr. C. B. Backer, discovered the excellent heat transfer and insulating properties of magnesium oxide and applied himself to perfecting a technique of burying a heater coil concentrically in a bed of magnesium oxide within an outer metal sheath.

In this form, elements can be touched without giving shock, can be bent to complex shapes to fit closely within or up to the body to be heated, can be immersed in liquids, can be made in a wide range of sheath metals or alloys to withstand corrosive conditions and can operate at any required temperature up to 800°C.

The original manufacturing process is one of chemical conversion using pure magnesium metal tubes between the heater coil and outer tubes as the source of magnesium oxide, the metal absorbing oxygen from water and steam in which it is immersed under pressure. A guaranteed concentricity is assured as, having started with a perfect tube of magnesium metal, a true annulus of magnesium oxide is produced during conversion.

The process is excellent for multiple small batch, tailor made requirements but is slow compared with the latest powder filling techniques which Backer use for bulk production of repetitive elements required by the Domestic Appliance Industry.

In this process the magnesium oxide powder is formed into an annulus around the heater coil on multi spindle vibrating filling machines whilst the coil is held in a concentric position within the outer sheath. Both processes have their advantages and allow Backer to offer you the 'Best of Both Worlds' - Heat, Shaped Heat, whether it be for raising the temperature of liquid, solid or gas.

Backer Electric Company Limited

The best of both worlds



the Backer 1 conversion process

Used generally for quantities up to 500 off —
and for specific applications requiring non-circular sections.

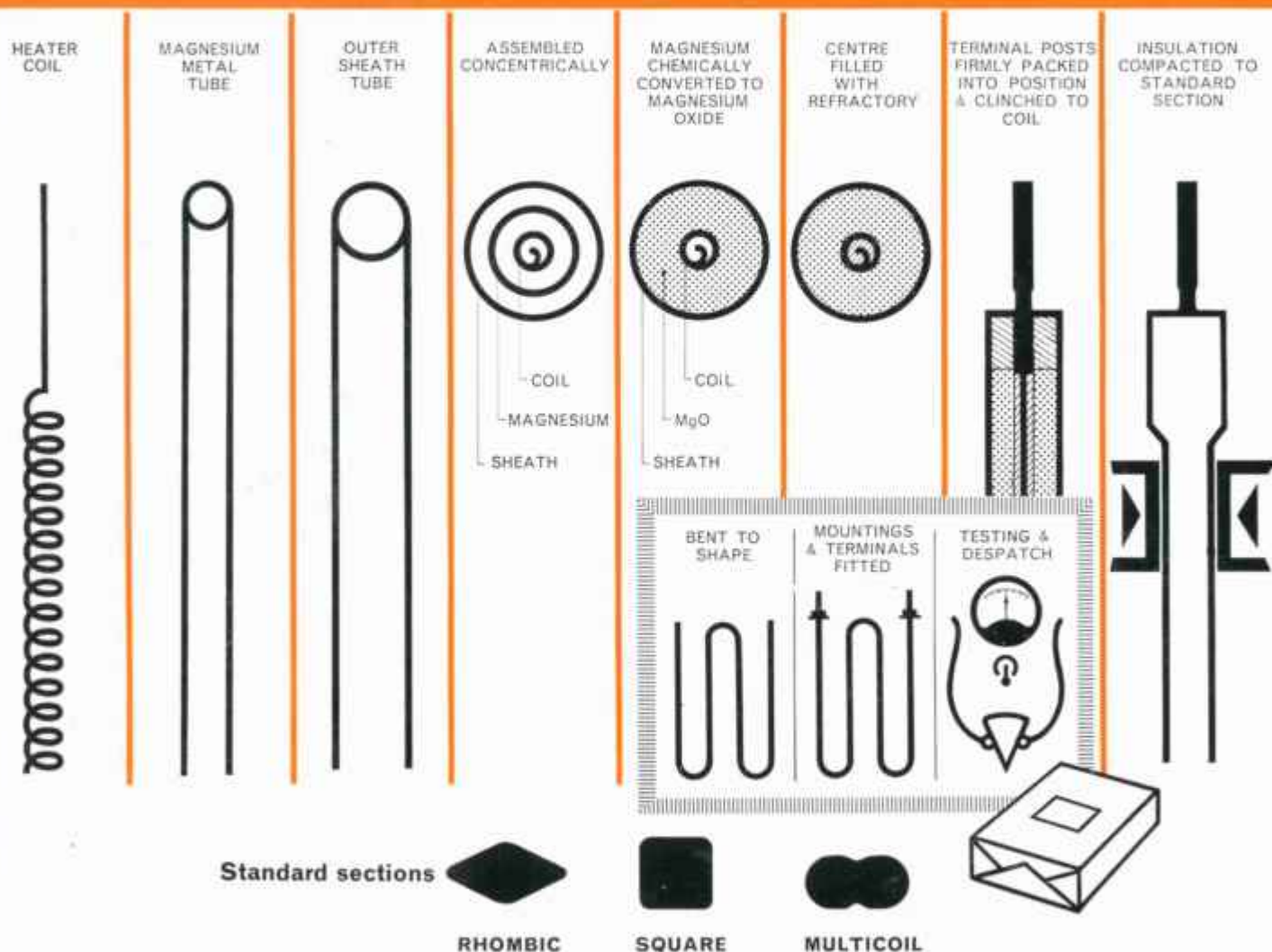

Advantages: Ideal for small batch production - guaranteed concentricity - square section gives maximum contact when groove embedded.

The **three standard sections** are Rhombic, Square and Multicoil, but Oval, Dee, Triangular, and Barrel sections are available for special requirements.

Two independent circuits can be confined within one sheath as a Multicoil element.

Although flattened, conversion elements do have a 1" length each end left round for ease of mounting ferrules or

fixing plates etc. and this length can be increased by arrangement.

Standard nominal sizes (original tube dia. and end dia.)
English .25" - .313" - .375" - .438" - .625"
Metric 6.4 - 7.9 - 9.5 - 11.1 - 15.9mm

Maximum length (including inactives) 112"

Sheath materials available: Inconel, Incoloy, Stainless Steel, Mild Steel, Monel, Copper, Aluminium Brass, Aluminium Bronze.

The length of inactive ends can be made to suit requirements, and can be produced with straight wire to give cool inactive, or reinforced for cold inactive.



2 the Backer powder filling process

Used generally for bulk production quantities of 500 and over and for applications specifically requiring a round section.

FUSED MAGNESIUM OXIDE POWDER



HEATER COIL



OUTER SHEATH TUBE



SOLID TERMINAL POSTS WELDED TO COIL



TUBE FILLED WITH MAGNESIUM OXIDE UNDER VIBRATION

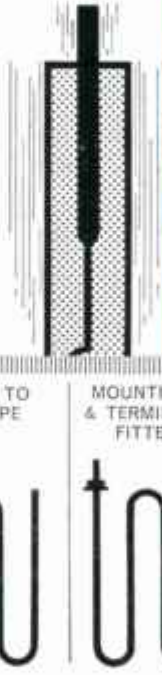

INSULATION COMPACTED BY REDUCING ROLLS



TRIMMED TO LENGTH (SEE NOTE#)



*NOTE: After compaction, elements vary in length by up to ± 1% and whilst they can be trimmed to length as shown it is cheaper to take up this variation at a non-critical point during bending.

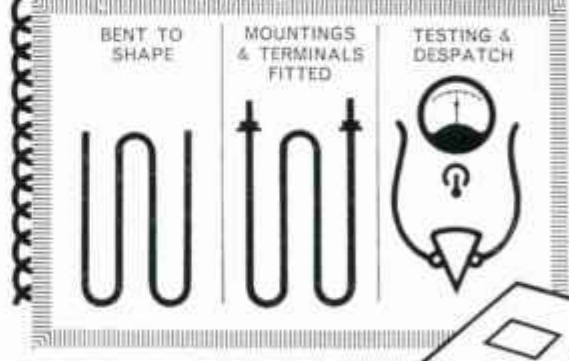

Standard section



CIRCULAR

Advantages: Truly round section throughout length - high temperature operation - ideal for bulk production - high flash and low earth leakage characteristics.

Standard nominal diameters

English .25" - .265" - .281" - .313" - .333" - .375" - .438"
Metric 6.4 - 6.72 - 7.1 - 7.9 - 8.5 - 9.5 - 11.1mm

Maximum length: (including inactives) 170"

Sheath materials available: Inconel, Incoloy, Stainless Steel, Mild Steel, Monel, Copper, Aluminium Brass, Aluminium Bronze, Aluminium.

The length of inactive ends can be made to suit requirements by varying solid terminal lengths.

Testing ensures quality



(top right) Each boiling plate produced by Backer Electric Co., is placed on load and whilst energised from a 250V supply a superimposed voltage of 1500V is applied across the insulation. This severe test is more stringent than BSS requirements but ensures that only plates of the highest quality reach the market.

(above) Whilst the plates are still hot they are immersed in water, the cooling action causes a considerable vacuum within the element which searches the sheath for flaws. If such a flaw exists - water is drawn into the insulation and is quickly detected by an insulation resistance test.

Another check to ensure a quality product



Sheath materials

The choice of material for the tubular sheath depends upon the application on which we shall be pleased to advise, given the full details of the duty the element is required to perform, and a selection can be made from the following list.

Copper

Is a first consideration for water or oil heating by direct immersion. Normal procedure is that the finished water heating units are dull nickel plated to give added protection and to provide a superior finish. Maximum recommended sheath temperature 450°C. (850°F.)

Mild Steel and copper bonded mild steel

Suitable for heating of air and other non-corrosive gases, for contact heating of metal bodies, and for heating by immersion in oils, waxes, compounds, soft metals etc., and for casting within certain metals. Mild steel protected by approved methods can be utilised for higher temperature applications such as oven elements for domestic electric cookers. Maximum recommended sheath temperature 450°C. (850°F.)

Aluminium Brass and Aluminium Bronze

Suitable for heating of air and certain other gases, particularly where a non rusting sheath is essential, e.g. for high humidity applications, and occasionally for contact heating of metal bodies. Aluminium Bronze has a much higher mechanical strength than Aluminium Brass, particularly in the hot condition, and is more resistant to scaling at elevated temperatures. Maximum recommended sheath temperature 500°C (930°F.)

'Monel'

Is mainly recommended where a high resistance to chemical attack is essential. It is used for the heating of certain vegetable oils by immersion. Maximum sheath temperature 500°C. (930°F.)

18/8 Stainless Steel

Can be used to advantage for heating air and certain other gases where temperature requirements are higher than permissible with the aforementioned metals, particularly where its anti-corrosion properties are advantageous. Maximum recommended sheath temperature 700-750°C. (1300-1380°F.)

'Inconel' and 'Incoloy'

Both these metals are nickel chromium iron alloys (typical analysis 78Ni 15Cr. and 34 Ni 21Cr. respectively) with 'Inconel' having the greater resistance to chemical corrosion, and they are used where the element is required to work at or near its maximum recommended operating temperature of 750-800°C. (1380-1470°F.) In many cases they can be used successfully for certain media injurious to other sheath metals.

Terminology of lengths and sections



The **conversion** process produces an element with non-circular cross section as shown below except for a length each end (standard 1") which is circular and suitable for the mounting by brazing of ferrules or fixing plates. Bending must take place only on the flattened section and can be on high corners (major axis) or low corners (minor axis).

BACKER CONVERSION PROCESS - Batch Quantity up to 500

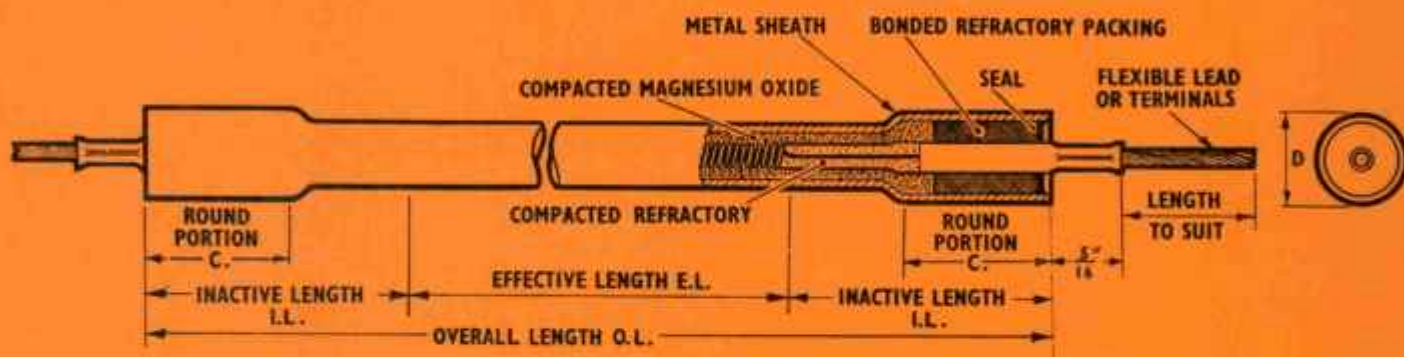

C — to suit (standard 1").

D — Nominal dia. & dia. of length C.

The **overall length** is the sheath length in straight form prior to bending.

The **effective length** is the active portion.

Inactive lengths can be produced at the end or at any part of the element and are usually straight wire which provides a comparative inactive section. If it is essential to have 'cold' inactives, requests should be made for reinforced inactives.

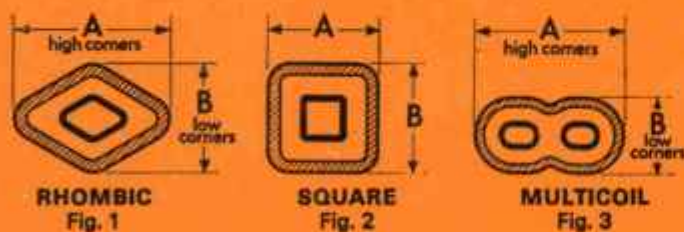

	Nominal Dia.	$\frac{1}{8}$ "		$\frac{3}{16}$ "		$\frac{1}{4}$ "		$\frac{7}{16}$ "		$\frac{1}{2}$ "					
		A	B	A	B	A	B	A	B	A	B				
CROSS SECTION DIMENSIONS	Rhombic (fig. 1)	.305	.215	.370	.265	.475	.312	.52	.375	.795	.50				
	Square (fig. 2)	.215	.215	.275	.275	.340	.340	.380	.380	—	—				
	Recommended Groove sizes for square section elements	width	.220 to .230	.280 to .290	.345 to .355	.390 to .400	—	—	depth	.200 to .195	.255 to .260	.320 to .325	.365 to .370	—	—
	Multicoil (fig. 3)	—	—	—	—	.312	.218	.562	.25	—	—				

The **maximum overall length** available including inactive ends is 112". Elements can be joined or inactive extensions added in low temperature zones if essential.

The **powder filling** process produces an element with a circular cross section throughout its length.

BACKER POWDER FILLING PROCESS - Bulk production over 500

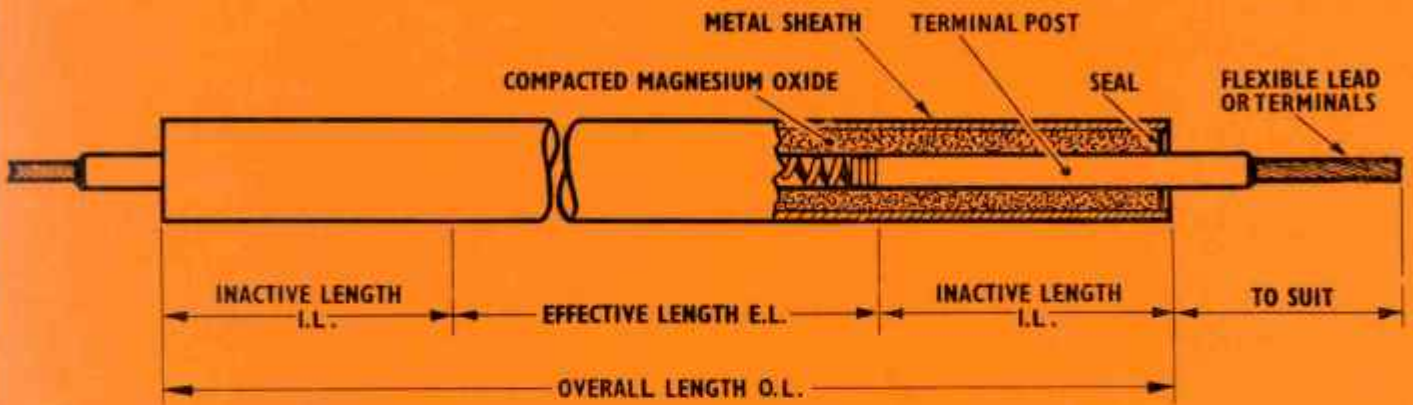

The **overall length** is the sheath length in straight form prior to bending. In production this length varies $\pm 1\%$ from nominal which variation is taken up at a non-critical point during bending. Cutting to exact length can be undertaken at extra cost.

The **effective length** is the active portion.

Inactive lengths can be provided only at the ends of the element.

Although primarily for bulk production, smaller quantities of elements can be produced by this process on request.

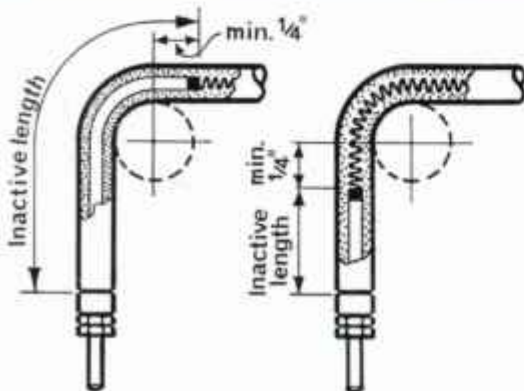

Bending should commence 1" or more from the tube end and be designed to ensure that the coil end of the terminal post does not lie nearer than $\frac{1}{4}"$ to a radius.

The **maximum overall length** available including inactive ends is 140". Elements can be joined or inactive extensions added in low temperature zones if essential.



Minimum bending radii

Bending and Forming

The Backer tubular sheathed element is relatively flexible and can be formed to any desired shape best suited for a particular installation. Whilst straight elements are supplied to order, it is generally recommended that the elements are formed at these works to the customers sketch or samples, so that full advantage is taken of the Company's experience and machinery. When submitting a shape to suit their requirements, customers should be guided by the table below which gives **minimum** bending radii for the different element sheath diameters - **these should be increased if the design allows.**

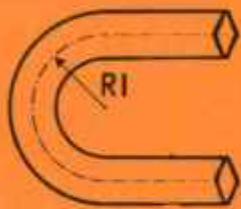

R1 - Minimum bending radius when bending on major axis (**high corners**)

R2 - Minimum bending radius when bending on minor axis (**low corners**)

Conversion process

Minimum Bending Radii

Powder Filling Process

Minimum Bending Radii

element dia.

element dia.

element dia.	Conversion process										Powder Filling Process				
	Minimum Bending Radii										Minimum Bending Radii				
	Rhombic Section				Square Section		Multicoil				element dia.	Group 1	Group 2		
Major Axis High corner		Minor Axis Low corner		Group 1	Group 2	Major Axis High corner		Minor Axis Low corner							
Group 1	Group 2	Group 1	Group 2			Group 1	Group 2	Group 1	Group 2	Group 1	Group 2	Group 1	Group 2		
1/2"	3/8"	3/8"	5/16"	5/16"	7/16"	3/8"							1/2"	3/8"	3/8"
3/8"	1/4"	1/4"	7/16"	3/8"	1/2"	7/16"							265	7/16"	3/8"
1/2"	3/4"	3/8"	7/16"	1/2"	3/8"	7/16"	1 1/4"	1 1/8"	1"	3/8"			333	7/16"	3/8"
7/16"	7/8"	3/4"	3/8"	9/16"	3/4"	3/8"	1 3/8"	1 1/2"	1 1/8"	1"			333	3/8"	7/16"
3/4"	2 1/4"	1 1/2"	1 1/2"	1 1/2"									333	3/8"	3/8"
													333	3/8"	3/8"
													333	3/8"	3/8"

Group 1 includes Inconel, Incoloy, Stainless Steel, Monel and Mild Steel.

Group 2 includes Copper, Aluminium Brass, Aluminium Bronze.

Note 1 For round section elements it may be possible to bend group 1 materials to Group 2 bending radii, after consideration of material, wall thickness and tooling.

Note 2 Radii are measured to centre line of element section.

When elements are supplied in straight lengths for bending by the customer, the following points should be specially noted. Elements are always bent in their cold condition, and in the case of conversion elements for bends up to about 1 1/2" to 2" diameter are usually formed between a suitably grooved form of the correct radius and a grooved former on the other side motivated by a bending lever and roller pivoted on the pin of the inner form tool, with the

element securely clamped at a point near where the bend takes to prevent the element from sliding. Grooved forms are not always necessary for powder filled elements. Larger bends can be formed on special jigs, but all bending requires a smooth steady action to prevent kinks or breakages. Bending operations should not be commenced within 1" of the element sheath end on unflattened portions of conversion process elements or within 1/4" of internal end of terminal posts of powder filled elements.

TERMINAL ASSEMBLIES



The following diagrams clearly indicate the size and make-up of a selected number of semi-standard terminations.

Not all terminations are suitable for all diameters of element, therefore a cross reference table on the back cover has been provided to assist selection.

Special terminals can be provided to order if necessary.

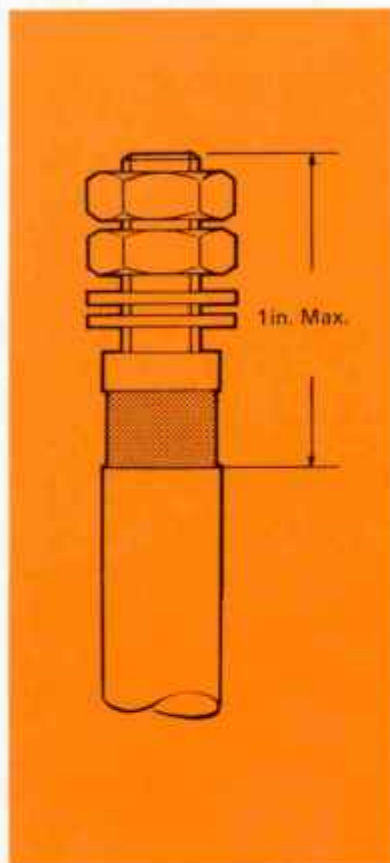

Code 1403
Title OBA Stainless Steel Pillar
Max. Temp. 650°C

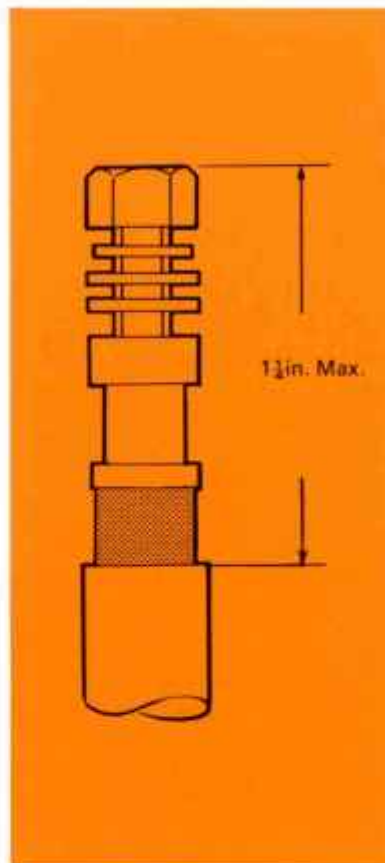

Code 239
Title 3BA Brass Pillar
Max. Temp. 350°C

Code 249
Title 3BA Stainless Steel Pillar
Max. Temp. 600°C

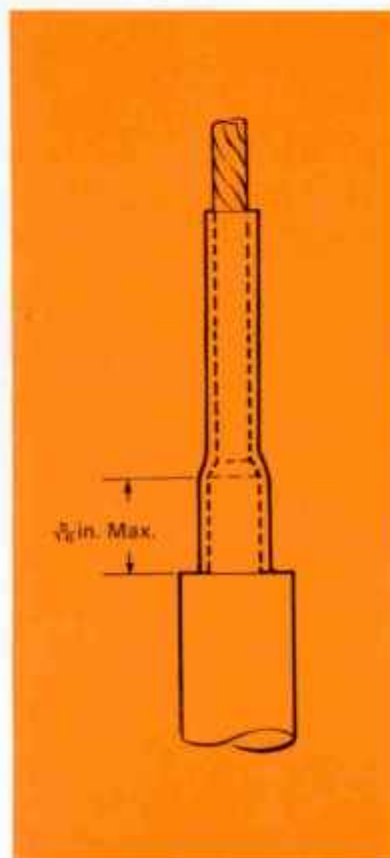

Code 238A
Title Flexible Nickel Chrome Leads - Unsleeved
Max. Temp. 600°C

Code 238B
Title Flexible Nickel Leads - Unsleeved
Max. Temp. 400°C

Code 1372
Title Flexible Nickel Leads - Sleeved
 Standard length 9in.
Max. Temp. 200°C

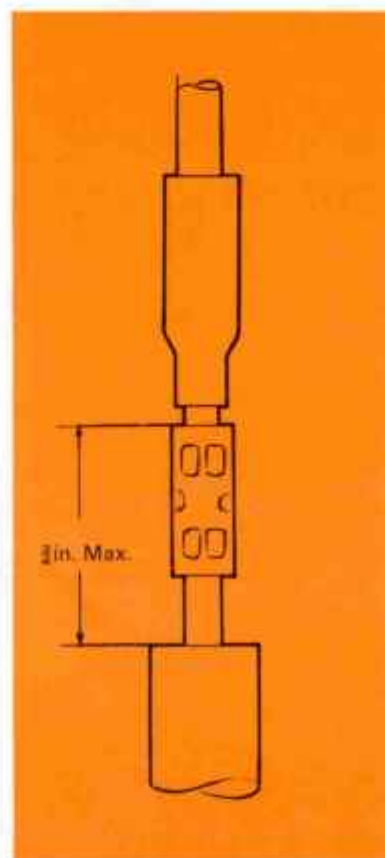
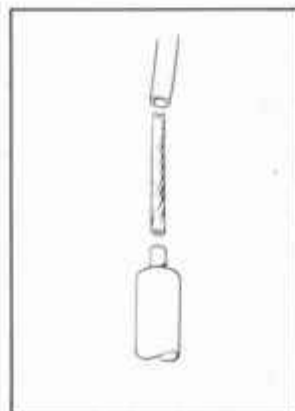

Code 1373
Title Clinched Glass Sleeved Cable
Max. Temp. 200°C

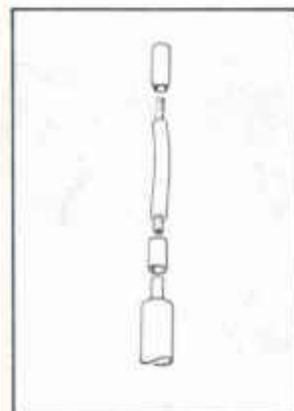

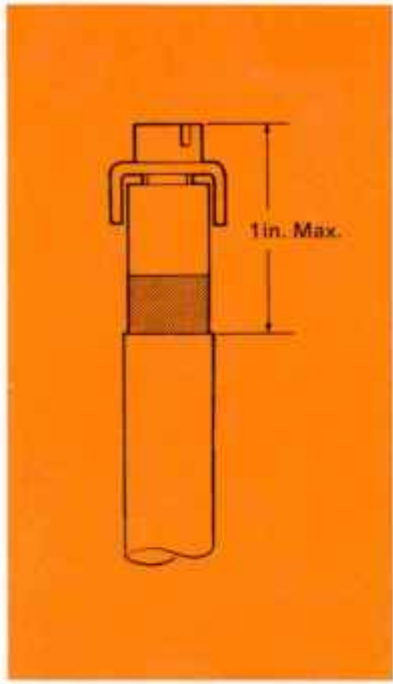

Code 1048
Title 2BA Brass Offset Terminal
Max. Temp. 350°C

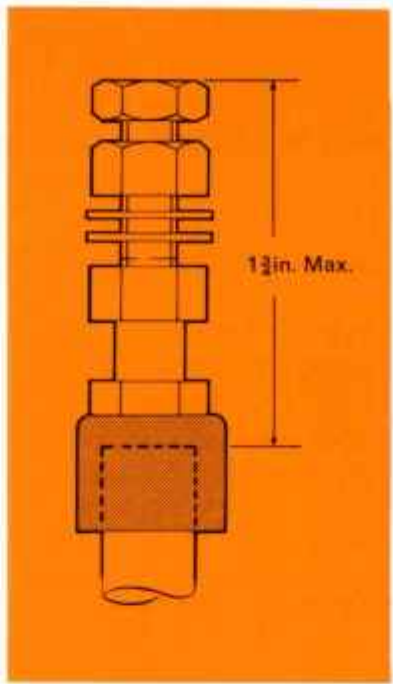

Code 237
Title Clinched OBA Brass Pinch Type Screw-on Terminal
Max. Temp. 350°C
 This terminal can be mounted on a 3/8 in. dia. parallel bead.
Code 750

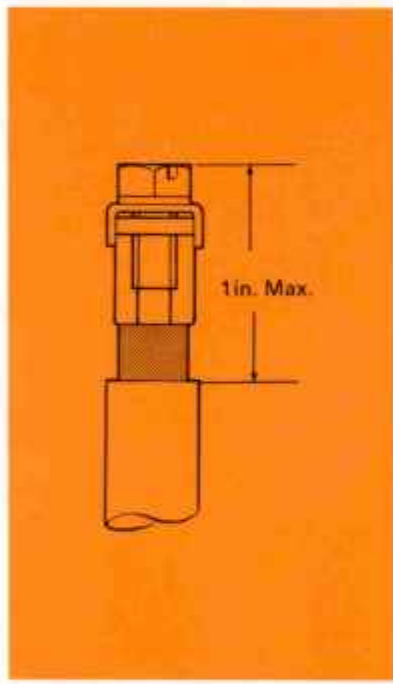
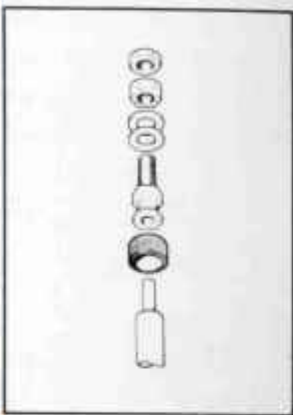

Code 240
Title 3BA Stainless Steel Angled Flag
Max. Temp. 400°C

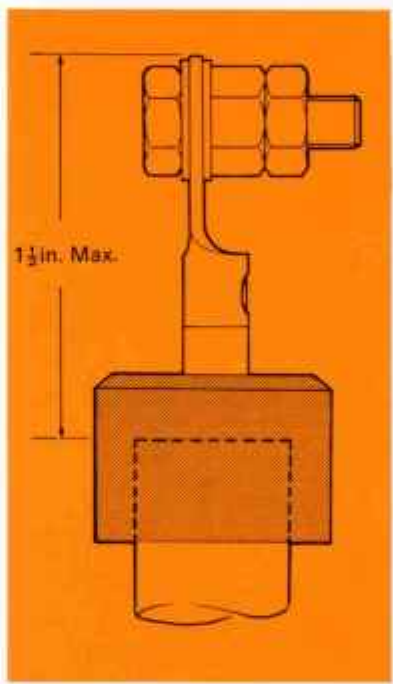
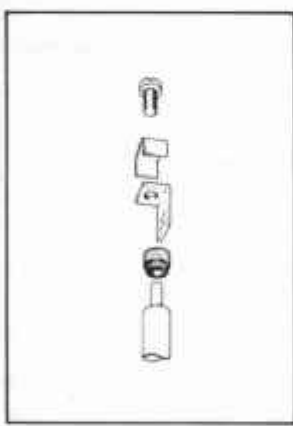

Code 1105
Title OBA - Clinched Ring Tongue
Max. Temp. 150°C

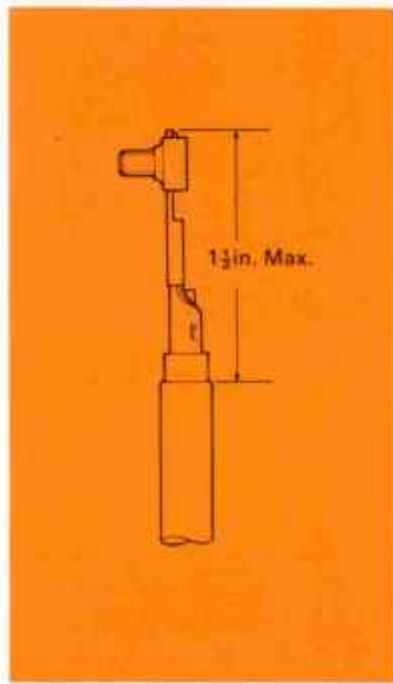

Code 1650
Title Std. Tab Terminal
Max. Temp. 350°C
 An adaptor is available to connect this terminal for lead connections.
Code DE.30

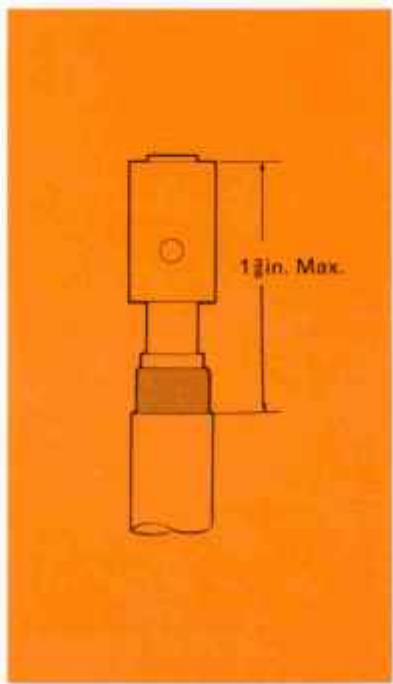
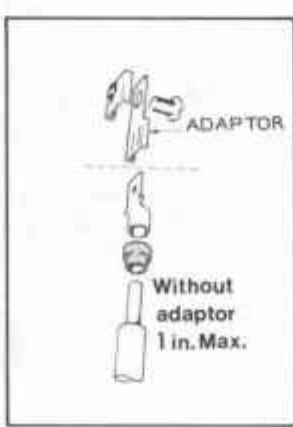

Code 776
Title 2BA Pinch Type Screw-on Terminal
Max. Temp. 350°C

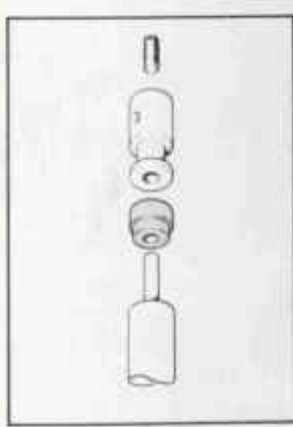

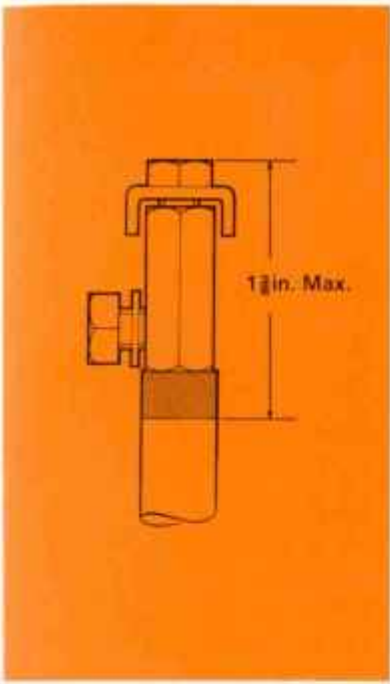

Code 768
Title 2BA Brass
 Removable Pillar
Max. Temp. 350°C

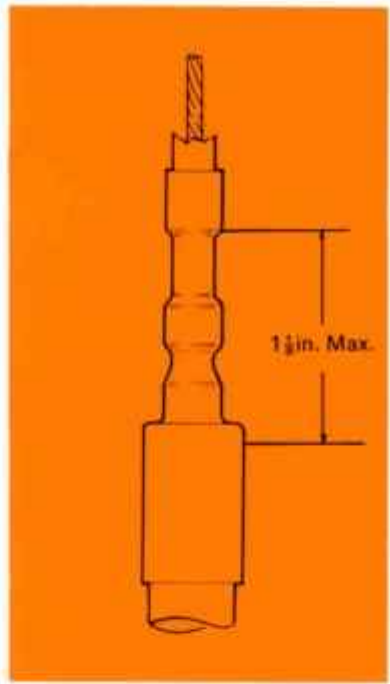
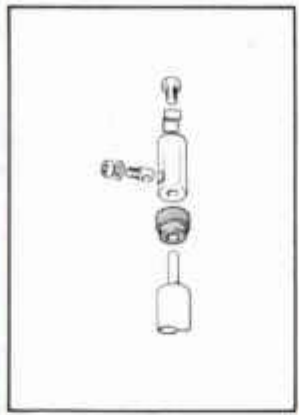

Code 1458
Title Watertight Flexible
 Connection
Max. Temp. 65°C

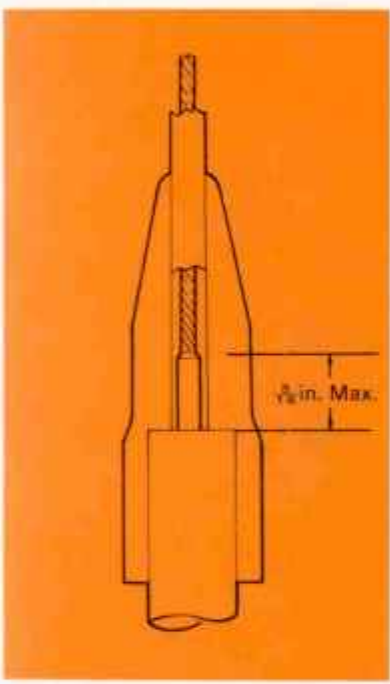
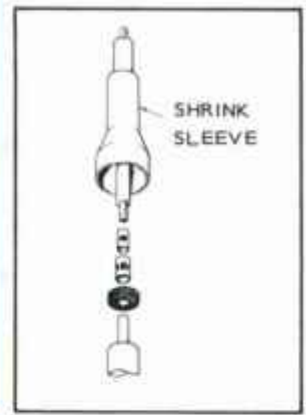

Code 1090
Title Anti-Condensation
 Shroud
Max. Temp. 65°C

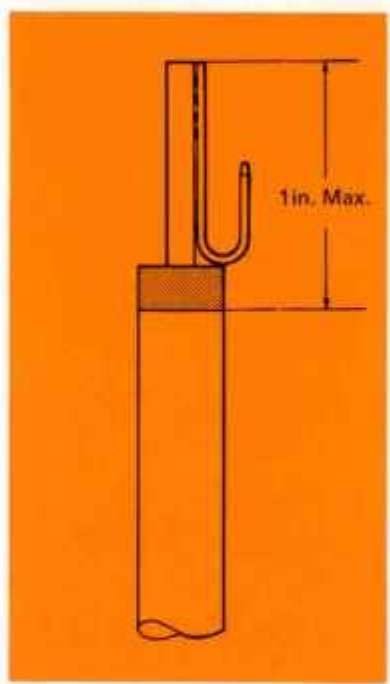
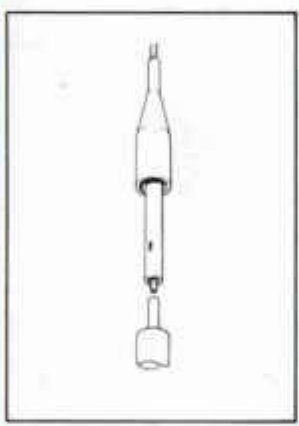

Code 1724
Title In-Line 'Piggyback'
 Tab
Max. Temp. 325°C

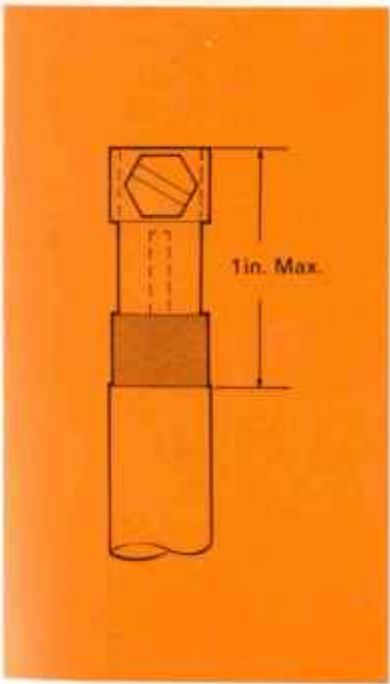

Code 1022
Title 3BA Stainless Steel
 In-Line Flag
Max. Temp. 400°C

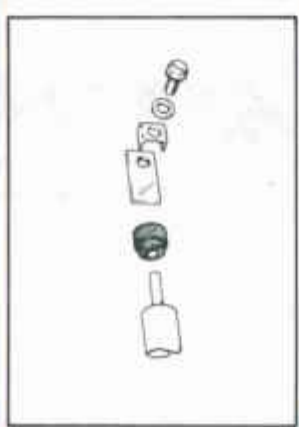

Code 1727
Title 4BA Screwed
 Terminal
Max. Temp. Mild Steel
 Plated 325°C
 Stainless
 Steel 500°C

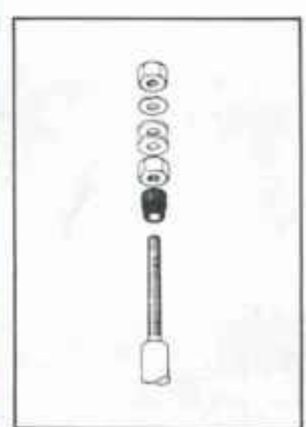

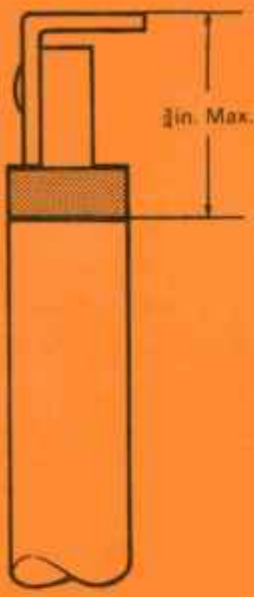

Code 1608
Title Right Angle Tab Terminal
Max. Temp. 325°C

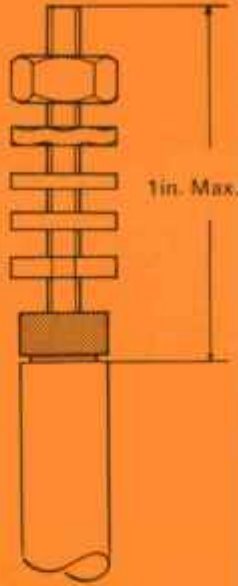
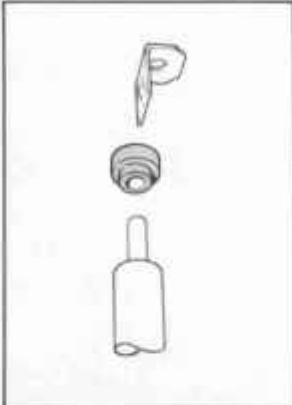

Code 1726
Title 58A Screwed Terminal
Max. Temp. Mild Steel Plated 325°C
Stainless Steel 500°C



CODE NO.	CONVERSION PROCESS ELEMENTS				
	1/2 in.	3/8 in.	3/4 in.	1/2 in.	1 in.
1458			●	●	
768		●	●	●	●
776		●	●	●	●
1372	●	●	●	●	●
1373		●	●	●	●
249	●	●	●	●	●
1403			●	●	●
1105			●	●	●
240	●	●	●	●	●
237			●	●	●
1048			●	●	●
1022	●	●	●	●	●
1090			●		
1726					
1727			●	●	●
1608	●	●	●	●	●
1724	●	●			
1650	●	●	●	●	●

POWDER FILLED ELEMENTS						
1/2 in.	0-265 in.	3/8 in.	3/4 in.	0-333 in.	1 in.	1/2 in.
	●	●	●	●	●	●
			●	●	●	●
●	●	●	●	●	●	●
		●	●	●	●	●
		●	●	●		
			●	●	●	●
			●	●	●	●
●	●	●	●	●	●	●
●	●	●	●	●	●	●
●	●	●	●	●	●	●



Shaped heat



solid or **radiant** cooker hotplates a comparison of the two approaches



Backer have the answer

Backer Electric Company of Rotherham, England
present facts that are of vital interest
to designers and manufacturers of domestic cookers
in the European Economic Community.

Backer

Backer lift-clear radiant boiling plates



designed for
easy cleaning

Backer Lift-clear Hotplates are manufactured to fit cookers with hobs to DIN standard 44912 (sheet 2). The shallow reflector units are interchangeable with solid hotplates to DIN standard 44910 (sheets 4 and 5). The deep reflector units are interchangeable with solid hotplates on cookers with one centimetre extra depth below the top of the hob thereby allowing higher power inputs to be applied to the elements.

All elements can be supplied at any voltage up to 380 volts and can be used with infinitely variable energy regulator controls or pan temperature sensing units. Full details are given in leaflet no GC24 and the complete range of Backer Radiant Hotplates is shown in leaflet no GC22A.

Backer
Shaped heat

Backer Electric Company Limited
Rotherham, Yorkshire, England
Telephone: 0709 78181
Telex: 54161

Backer lift-clear radiant boiling plates



Designed to replace hob mounted or solid hotplates on certain British and European cookers, this special Backer range has swivel fixing plates which allow the element to be lifted clear of the reflector for cleaning.

Four types of these side swivel plates will be available for deep or shallow hobs in nominal 6" or 7" diameter, metric sizes of 145 mm or 180 mm—single circuit 1200W, 1800W or 2000W—fitted with tab terminals.

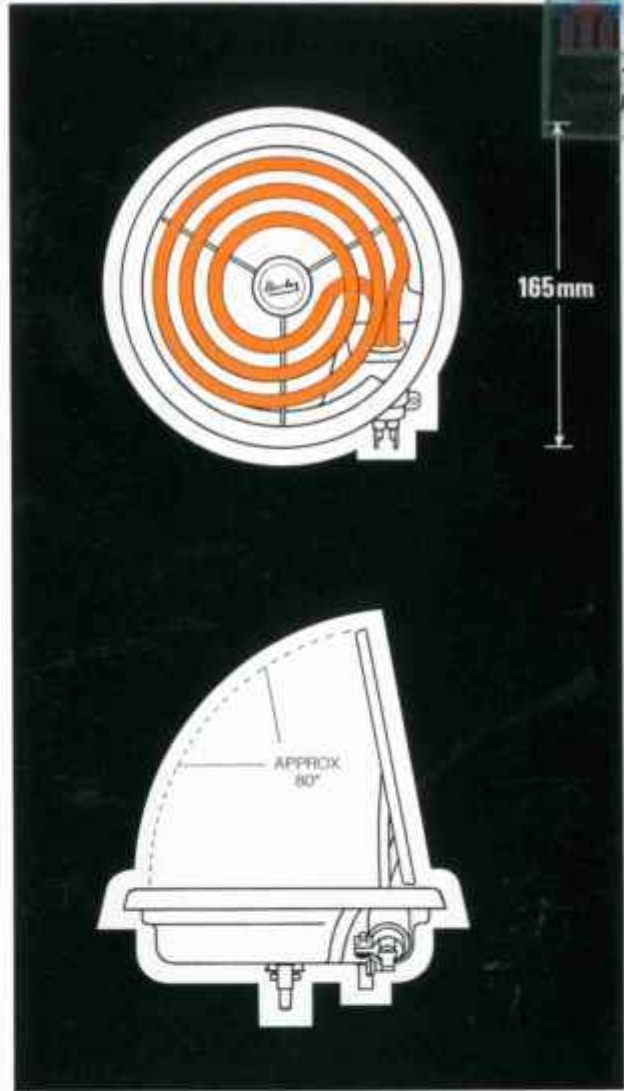
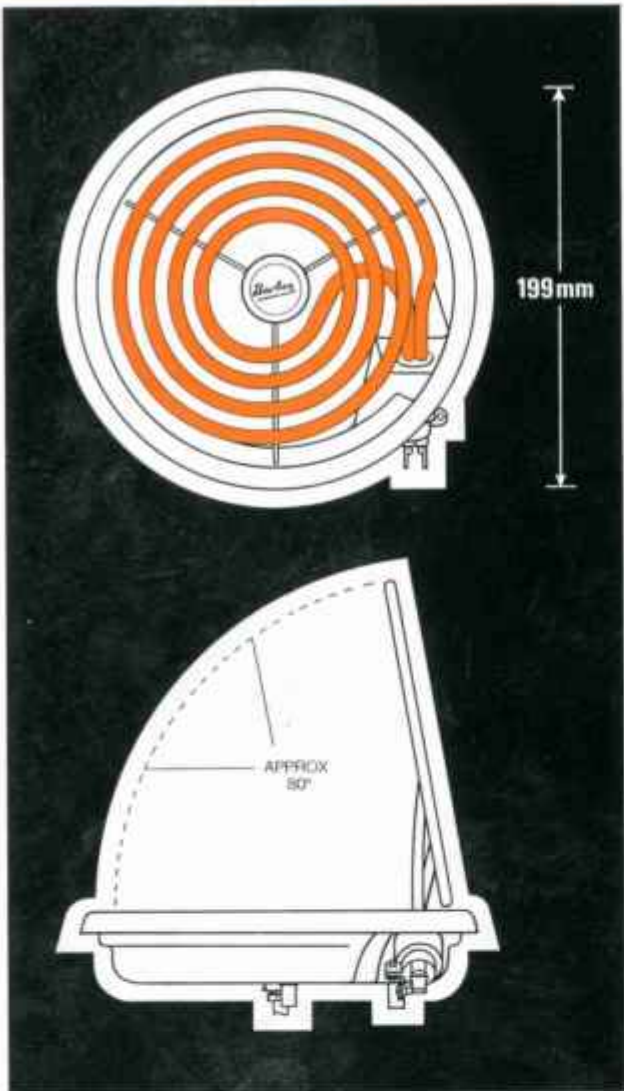

Plate Code:

SS180D

Type:

2000W, 240V, 180 mm (7" nominal) diameter, four-turn single circuit with tab terminals and deep reflector

Suitable for replacing:

Some European hob-mounted units to DIN Specification 44912

Plate Code:

SS180S

Type:

1800W, 240V, 180 mm (7" nominal) diameter, four-turn single circuit with tab terminals and shallow reflector

Suitable for replacing:

All European solid hot plates to DIN Specification 44910 (Sheet 4) and hob-mounted units to DIN Specification 44912

Plate Code:

SS145D

Type:

1200W, 240V, 145 mm (6" nominal) diameter, three-turn single circuit with tab terminals and deep reflector

Suitable for replacing:

Some European hob-mounted units to DIN Specification 44912

Plate Code:

SS145S

Type:

1200W, 240V, 145 mm (6" nominal) diameter, three-turn single circuit with tab terminals and shallow reflector

Suitable for replacing:

All European solid hot plates to DIN Specification 44910 (Sheet 4) and hob-mounted units to DIN Specification 44912

*For full range of plates see
Publication No. GC.22A*

Backer
Shaped heat

Backer Electric Company Limited
Rotherham, Yorkshire
Telephone: 0709 78181
Telex: 54161



why
Backer
radiant hotplates?

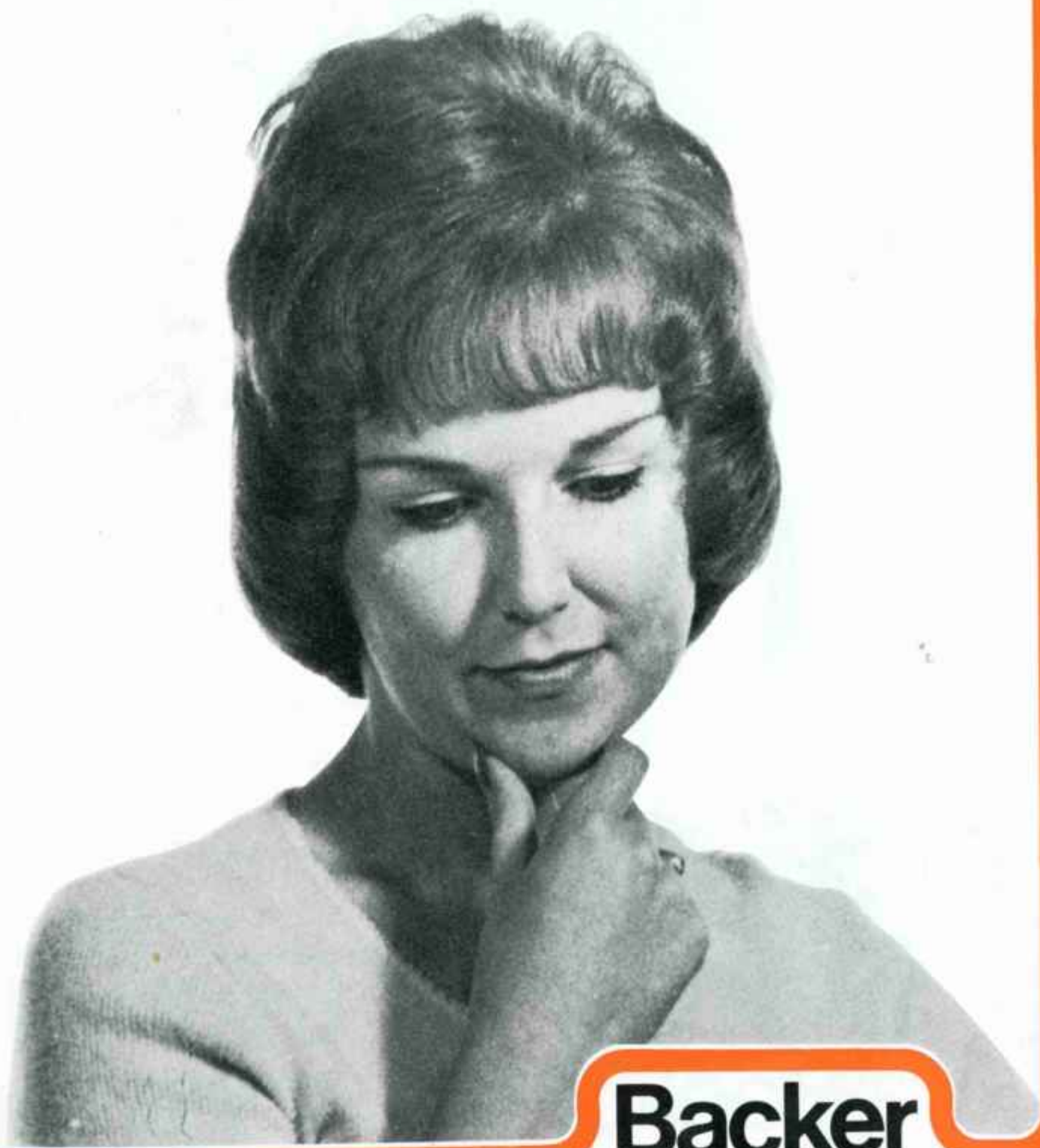

Backer

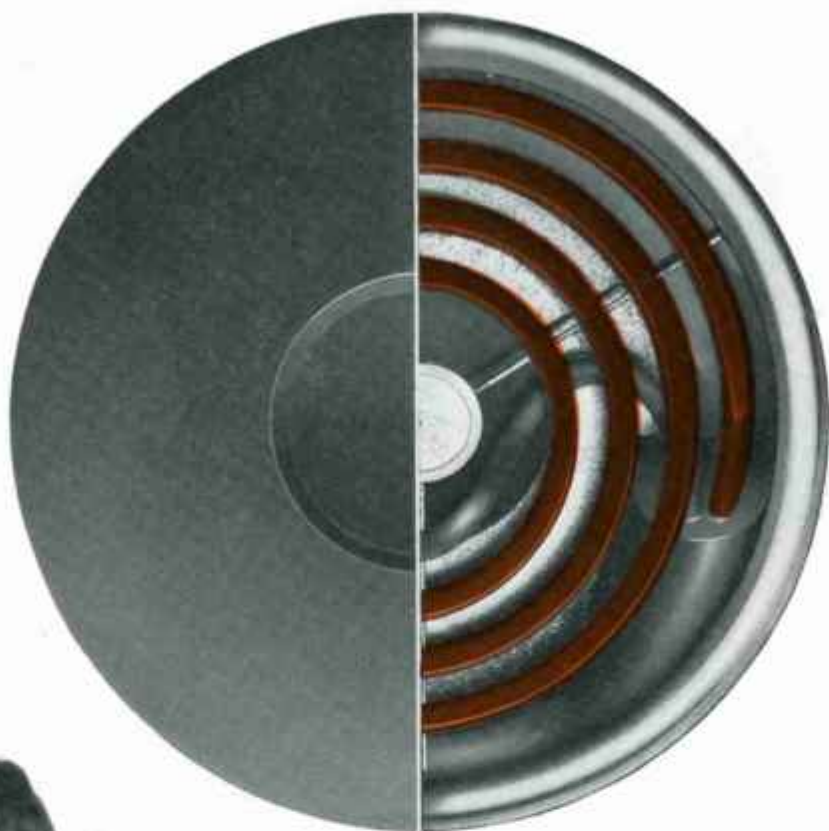

because they

- 1/ Heat nearly twice as fast as standard solid hotplates
- 2/ Reduce cooking costs because of their greater efficiency
- 3/ Provide easily controllable heat
- 4/ Do not rust or crack
- 5/ Swivel clear to enable spillage bowls to be cleaned easily
- 6/ Are interchangeable with solid hotplates

"Where can I get them?"

From any cooker manufacturer supplied by

Backer
Shaped heat

Backer Electric Company Limited
Rotherham, Yorkshire, England
Telephone: 0709 78181
Telex: 54161

Backer kettle elements and accessories



fit all
standard
kettles

Just three Backer elements to fit any standard kettle!

Total rationalisation of the Backer range of kettle elements has reduced your stock requirements to just three types of element to fit any standard electric kettle purchased in the U.K.

The design incorporates a special adaptor washer which FITS EITHER 1 $\frac{1}{16}$ " or 1 $\frac{1}{8}$ " HOLES.

New range:

Pack 1A 1500W Recommended for 2-pint kettles.
Pack 3A 2750W (Recommended for 3-pint or
Pack 4A 3000W larger kettles.

Specification

The elements have $\frac{5}{16}$ " diameter, chromium-plated copper sheaths, with 80/20 nickel chrome resistance wire in compacted magnesium oxide insulation, and incorporate Otter V90 'Kettle-Guard' self-resetting cut-outs for boil-dry protection.

Backerdaptor element packs

Contents: Element, special washer, external joint washer and shroud.

For 3-pin replacements:

Pack 1A 1500W 240V
Pack 3A 2750W 240V
Pack 4A 3000W 240V

For 2-pin replacements:

Use packs 1A, 3A or 4A plus accessory pack 21 (3-pin connector without flex) or 22 (3-pin connector with flex).

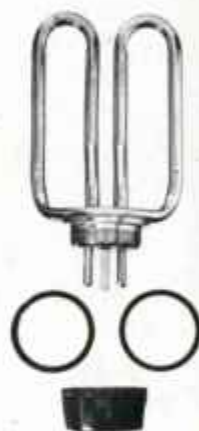

How to select the right pack

When purchasing a new element, customers usually bring either the complete kettle or the failed element.

How to identify the correct Backer replacement.

1/ If the element has three pins (diagram A) you need BACKERDAPTOR PACK 1A, 3A or 4A.

2/ If the element has two pins (diagram B) you need BACKERDAPTOR PACK 1A, 3A or 4A. PLUS ACCESSORY PACK 21 or 22.

All Backer elements fit either 1 $\frac{1}{16}$ " or 1 $\frac{1}{8}$ " diameter apertures.

Special pack 29 must be used for Russell Hobbs kettles.

A full range of accessory packs is available as shown on the back page of this leaflet.

This is ►
STANDARD
3-pin element

Diagram A



This needs ►
CONVERSION
2-pin element

Diagram B



Fitting instructions

If the kettle has a 1 1/16" diameter hole (Hotpoint-Premier-Prestige), remove the U-section washer from the kettle element and locate it in the hole, as shown in diagram E, so that half the washer is inside and half outside the kettle.

If the kettle has a 1 9/16" diameter hole (most other makes) leave the U-section washer on the kettle element as in diagram F.

NOTE: Russell Hobbs (pack 29) elements must be fitted by a competent electrician to manufacturers' instructions.

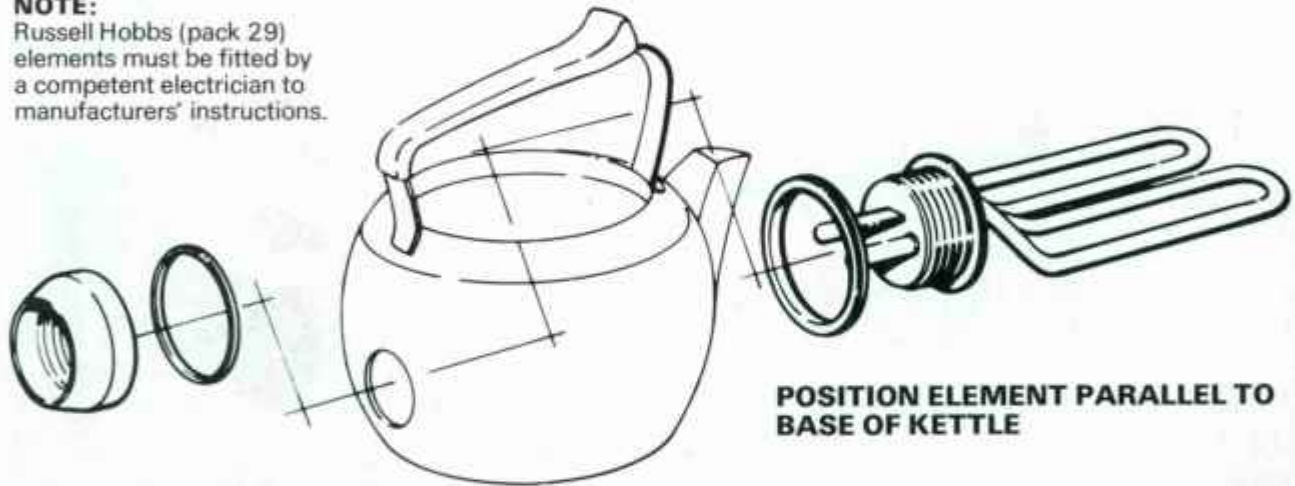
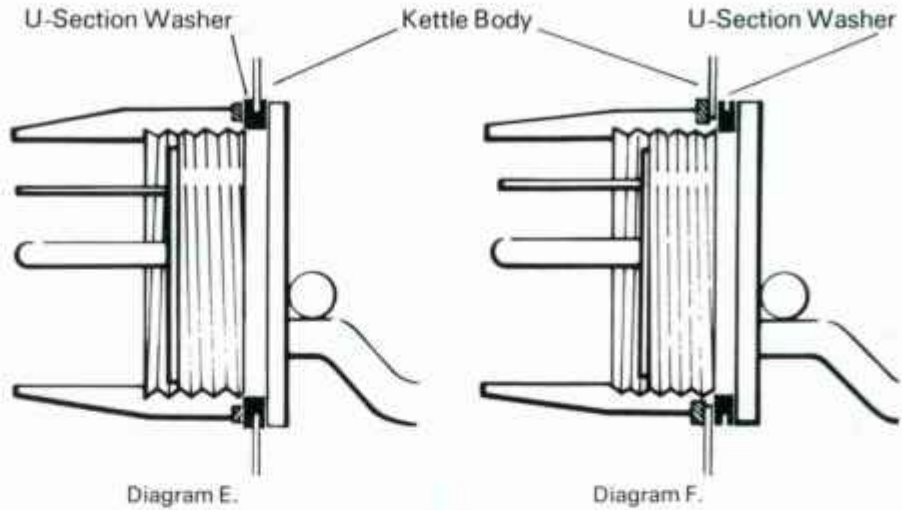

Special packs for Russell Hobbs Kettles

Contents: Element with ferrules, nuts and washer – plus washer for the heat sensor, max. level plate and thermal adjustment screw.

Pack 29 for models K2S and K2R 2400W 240V

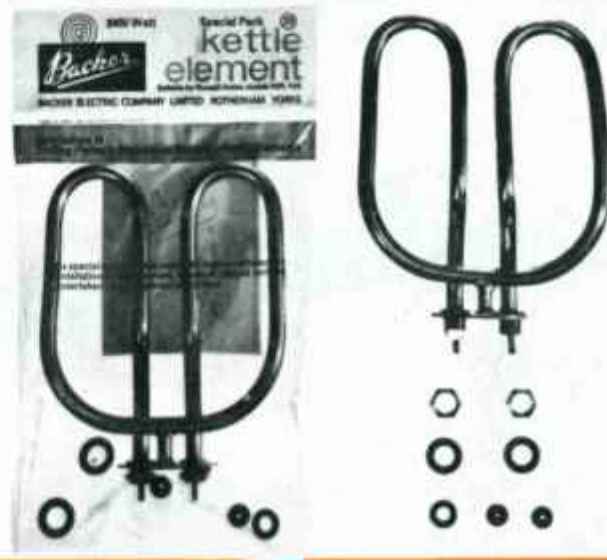

Accessory packs

Pack 17



1 1/2" Chromed Brass Connector Shroud

Pack 18



1 1/2" Nylon Connector Shroud

Pack 19



1 1/2" Nylon Connector Shroud

Pack 20



1 1/2" Chromed Brass Connector Shroud

Pack 21



3-pin Connector only

Pack 22

3-pin Connector
and 1-metre Flex



Pack 23



1 1/2" Washer Set -
1 Neoprene, 1 Fibre

Pack 24



1 1/2" Washer Set - 1 Neoprene, 1 Fibre

Pack 25



1 1/2" to 1 3/8" Extension Washer

Pack 26

Descaler



Pack 27

Backerdaptor washer
and fibre washer
to fit either 1 1/2"
or 1 1/4" aperture.



NEW!
Ask for details of our range
of 'Steam-Stat' elements
as used in various steam-
controlled kettles.

Backer

Backer Electric Company Limited
Rotherham, Yorkshire
Telephone 78181 (STD 0709)
Telex 54181

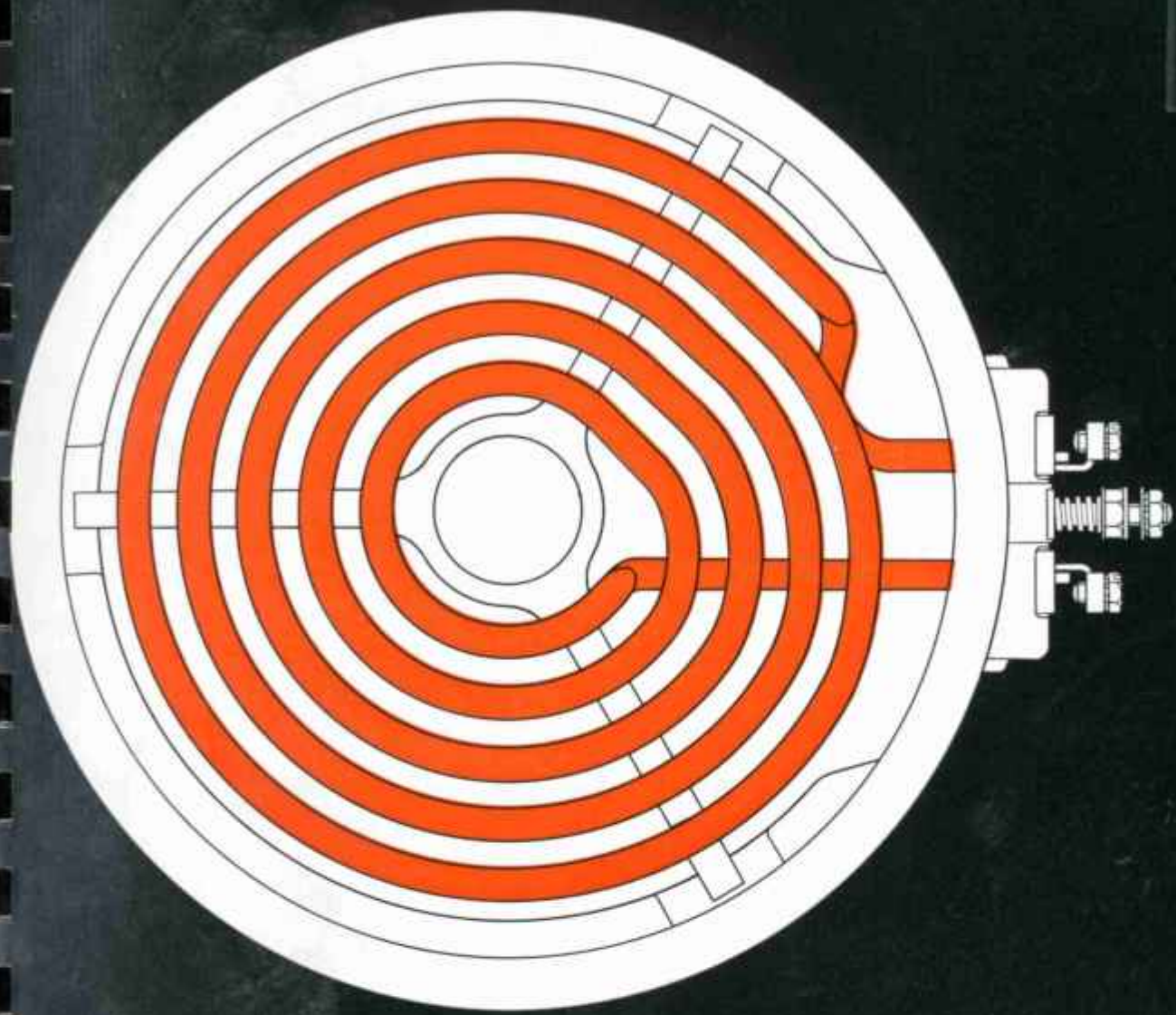

RADIANT BOILING PLATES



Backer
Shaped heat

Europe's leading heating element specialists

Backer STANDARD



Single and Twin Element Units

The following diagrams show standard single and twin element boiling plates as used on most cookers produced between 1960 and 1973. Note that in many cases the only difference between the plates is the type of terminal used, screw type terminals being used up to 1968, tab type terminals being used from 1969 onwards. Twin screw/tab terminals which fit both pre and post 1968 cookers are also available for many types.

Screw Terminals consist of 3BA phosphor bronze screws in stainless steel flags.

Tab Terminals consist of AMP clinched or welded male flags.

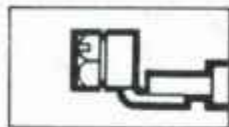

Twin Terminal.

Terminal and view of fixing plate.

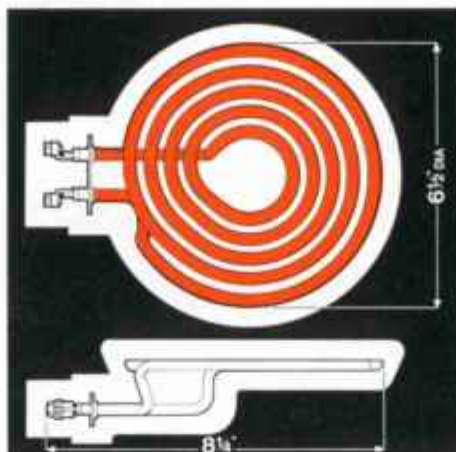
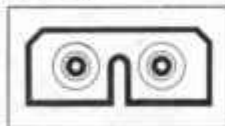
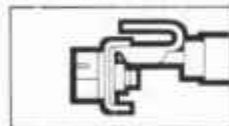

7D1/2 2000W. 7" diameter – 5 turn – single circuit. With fixing plate and screw terminals.

Use – most cookers produced between 1961 and 1968.

7D1/2 2400W. As above but with higher wattage.

Use – Creda 1966/8.

7D1/3 1000W. As above but with lower wattage.

Use – Tricity Popular (Pre 1969).

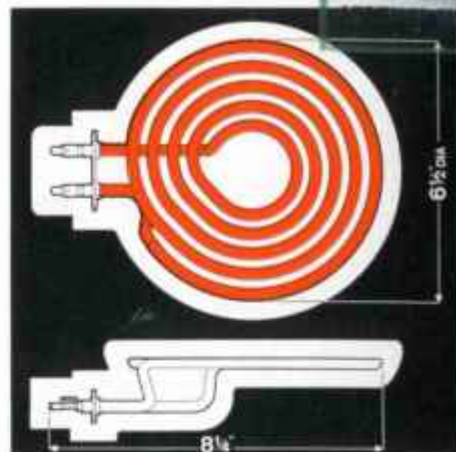

7D1/4 2000W. 7" diameter – 5 turn – single circuit. With fixing plate and tab terminals.

Use – most cookers produced since 1969 and interchangeable with 7D1/5.

7D1/4 2250W. As above but with higher wattage.

Use – Creda 1969.

7D1/4SS 1000W. As above but with lower wattage and stainless steel sheath.

Use – Tricity Popular (Post 1968).

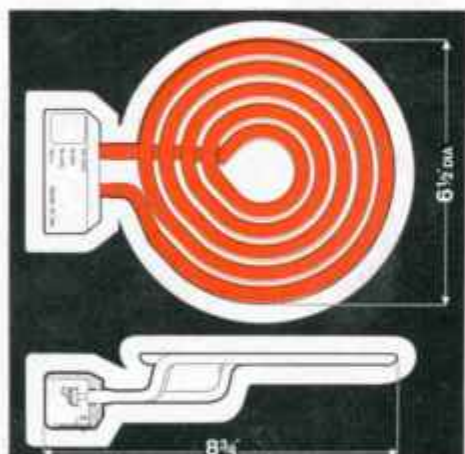

7D1 2000W. 7" diameter – 5 turn – single circuit. With aluminium terminal housing.

Use – exclusively for Tricity 1960 models.

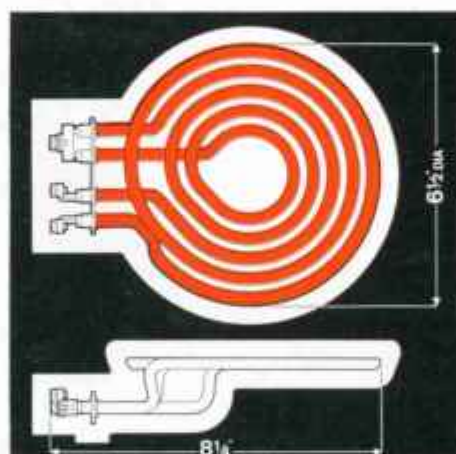

7D2/2 2000W. 7" diameter – 5 turn – twin circuit. With fixing plate and screw terminals.

Use – Hoover-Belling 1968

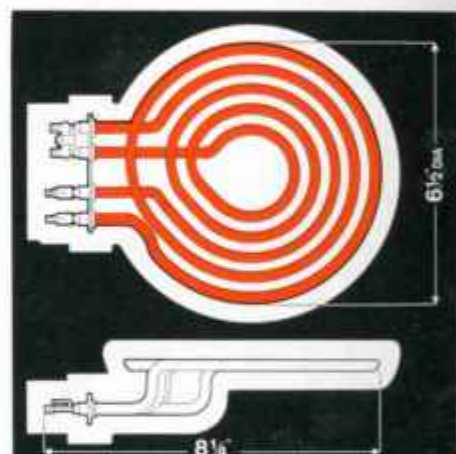

7D2/4 2000W. 7" diameter – 5 turn – twin circuit. With fixing plate and tab terminals.

Use – Hoover-Belling 1969.

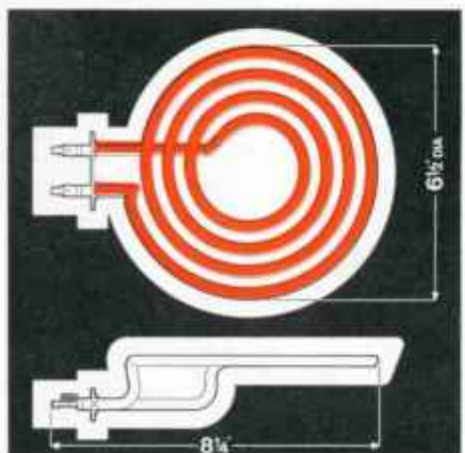

7D1/5 2000W. 7" diameter – 4 turn – single circuit. With fixing plate and tab terminals.

Use – most cookers produced since 1969 and interchangeable with 7D1/4.

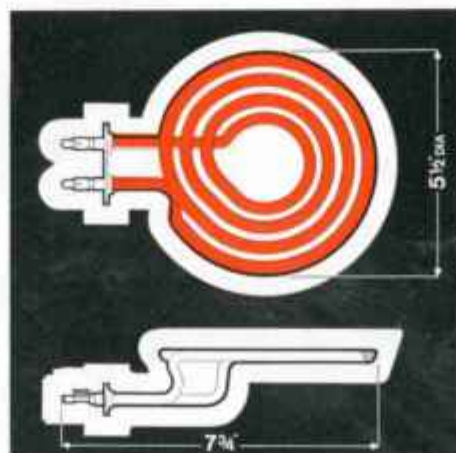

6D1/4 1500W. 6" diameter – 4 turn – single circuit. With fixing plate and tab terminals.

Use – Creda 1970.

6D1/2 1650W. As above but with higher wattage and screw terminals.

Use – Belling and Creda (Pre 1969).

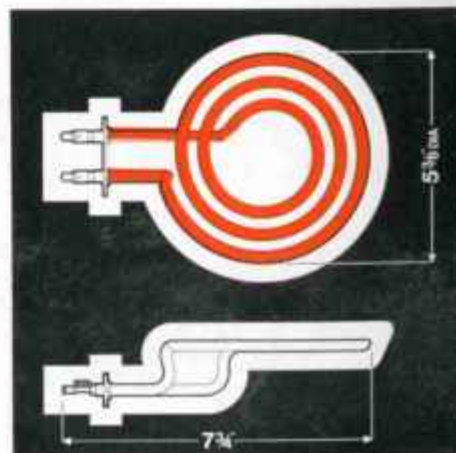

6D1/5 1200W. 6" diameter – 3 turn – single circuit. With fixing plate and tab terminals.

Use – Tricity (Post 1969).

6D1/5 1000W. As above but with lower wattage.

Use – Belling 1971

RADIANT BOILING PLATES



Twin Terminal Element Units

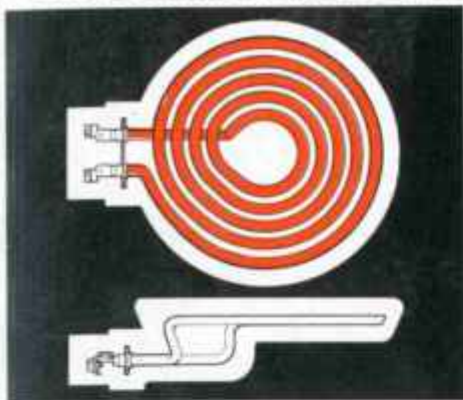

7D1/245/5 (registered design applied for) 2000W. 7" diameter – 5 turn – single circuit. With twin tab and screw terminals. Use – replacement for 7D1/2, 7D1/4, 7D1/5 2000W units.



6D1/245/4 (registered design applied for) 1500W. 6" diameter – 4 turn – single circuit. With twin tab and screw terminals. Use – replacement for 6D1/2, 6D1/4, 1500W and 6D1/5 1000W.

Hob-Mounted Units

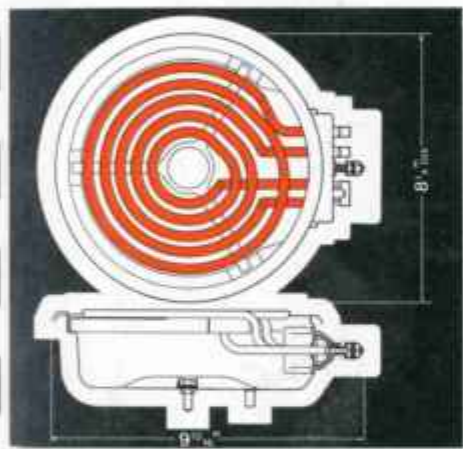

SH7D2/4 2000W. 7" diameter – 5 turn – twin circuit. Sealed hob unit with tab terminals (i.e. 7D2/4 in vitreous sealed reflector bowl). Use – Tricity Moffat (Post 1971), Carron (Post 1972)

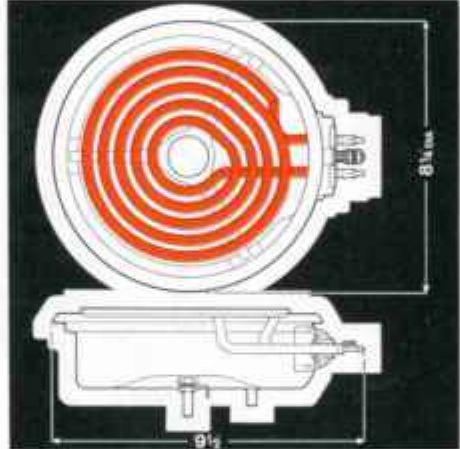

SH7D1/4L 2000W. 7" diameter – 5 turn – single circuit. Sealed hob unit with tab terminals (i.e. 7D1/4 in vitreous sealed reflector bowl fitted with location lugs). Use – Tricity Caprice and Moffat (Post 1968).
SH7D1/4PC 2000W. As above but with reflector for Pan control device. Use – Tricity Caprice and Moffat (Post 1968.)

Shown on front cover:

SH7D1/2 2000W. 7" diameter – 5 turn – single circuit. Sealed hob unit with screw terminals (i.e. 7D1/2 in vitreous sealed reflector bowl). Use – Tricity Caprice 1968.

SH7D1/2PC 2000W. As above but with reflector for pan control device. Use – Tricity Caprice 1968.

Lift-Clear Element Units



SS220D 2200W. 220mm (9" nominal) diameter – 5 turn – single circuit lift-clear swivel element. With tab terminals and deep reflector.

SS220S 1800W. As above but with lower wattage and shallow reflector.

SS220 2200W. or 1800W. As above but without reflector.

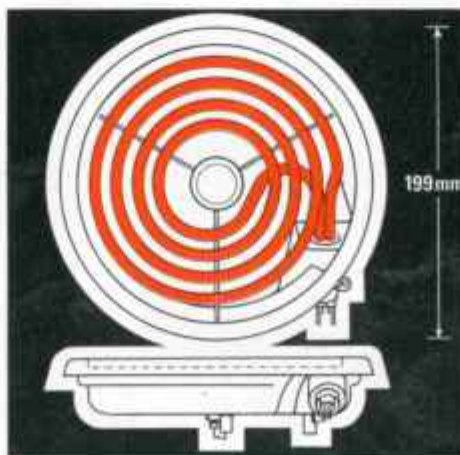

SS180D 2000W. 180mm (7" nominal) diameter – 4 turn – single circuit lift-clear swivel element. With tab terminals and deep reflector.

SS180S 1800W. As above but with lower wattage and shallow reflector.

SS180 2000W or 1800W. As above but without reflector.

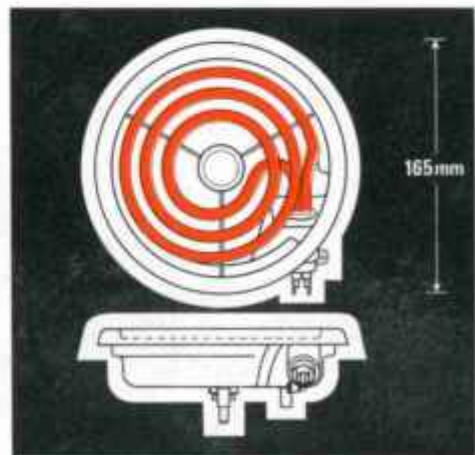

SS145D 1200W. 145mm (6" nominal) diameter – 3 turn – single circuit lift-clear swivel element. With tab terminals and deep reflector.

SS145S 1200W. As above but with shallow reflector.

SS145 1200W. As above but without reflector.

Deep Reflector Plates are suitable for some European hob-mounted units to DIN Specification 44912.

Shallow Reflector Plates are suitable for all European solid hot plates to DIN Specification 44910 (Sheet 4) and hob-mounted units to DIN Specification 44912.

Backer STANDARD RADIANT BOILING PLATES

EDA Plug-in Units

The following single and twin circuit plug-in EDA boiling plates are suitable for most cookers produced between 1945 and 1960. The single circuit units have two pins and earth pin as shown on the upper gauge and the twin circuit units have three pins and earth pin as shown on the lower gauge. To use these identification gauges, lay plate on its face with pins uppermost, place gauge over pins and read off code numbers of Backer equivalent against the relevant diameter.

Nov
rence
-1

AMP
male f

**Upper Gauge
Single Circuit
Plates**

If Plate Dia.	Backer Equivalent
8"	87V1
6½"	65V1

Termin

**Lower Gauge
Twin Circuit Plates**

If Plate Dia.	Backer Equivalent
8"	87V2
6½"	65V2



71"

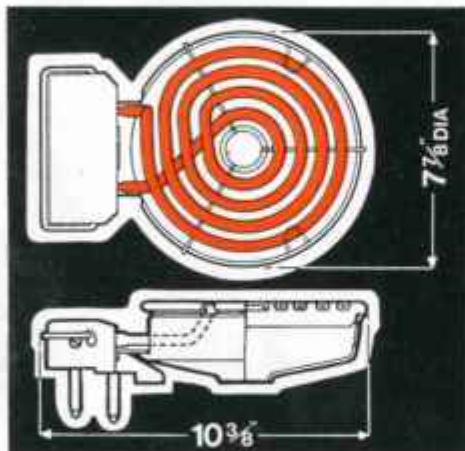

87V1 2150W. 8" diameter single circuit EDA unit.

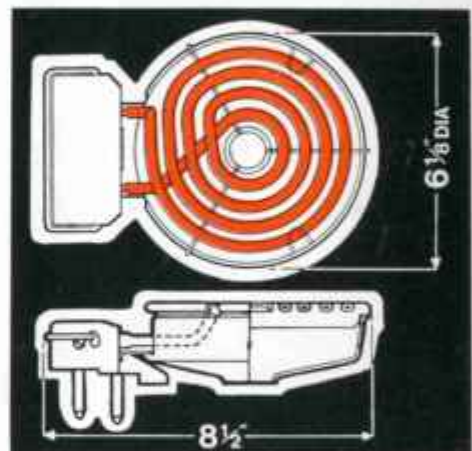

65V1 1350W. 6½" diameter single circuit EDA unit.

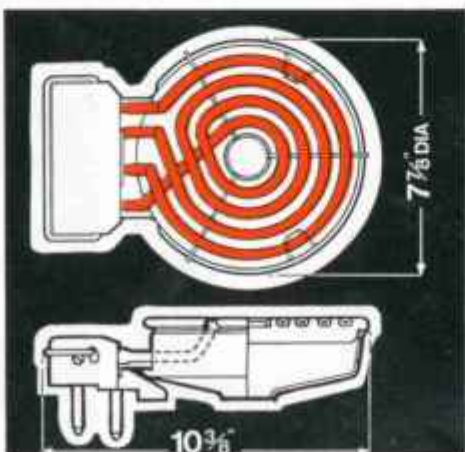

87V2 2150W. 8" diameter twin circuit EDA unit.

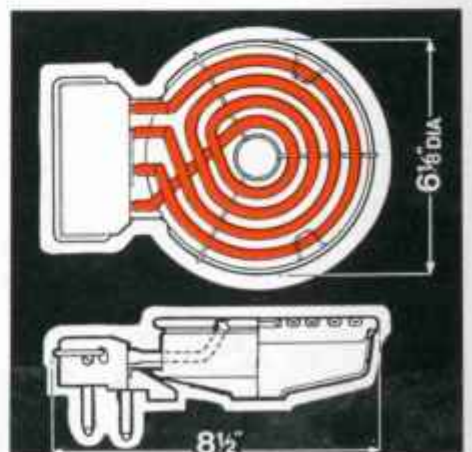

65V2 1350W. 6½" diameter twin circuit EDA unit.

Europe's leading heating element specialists

Backer

BACKER ELECTRIC COMPANY LIMITED

Rotherham Yorkshire

Telephone: 0709 78181 Telex: 45161

Shaped heat

PRICE LISTS

- B.P.1 Recommended List
- B.P.3 Electricity Board
- B.P.4 Export
- B.P.5 Wholesale



BACKER
TWIN-
TERMINAL
BOILING
PLATES

Yet another move in Backer's policy of reducing stock ranges to the absolute minimum. These new Twin-Terminal Boiling Plates eliminate the need to stock both tab and screw-type terminal plates in the single circuit 7" and 6" diameter sizes.

Think how this will release your valuable storage space, reduce capital tied-up in stock and simplify record keeping and sales identification.

See over for full details.

Backer Twin-Terminal Boiling Plates

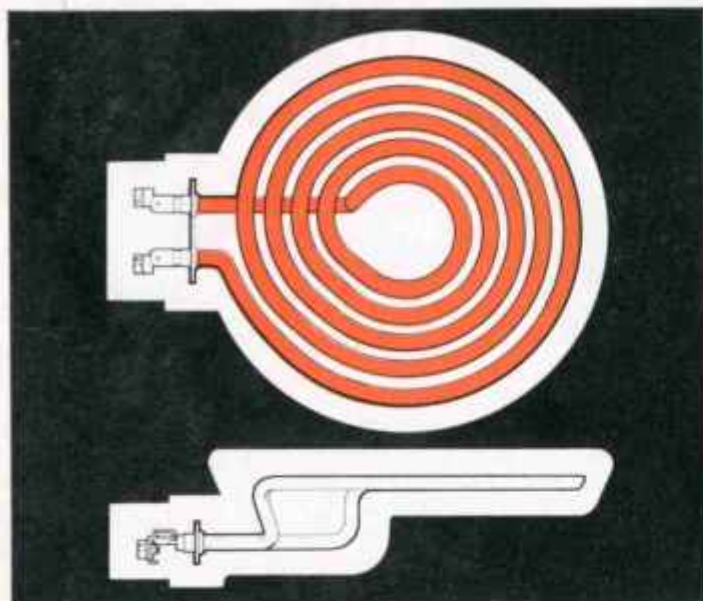

New Plate Code

7D1/245/5

Registered Design applied for

Type

2000W. 240V. 7" Dia. 5-turn
Single circuit plate with
combination tab and screw terminals

Suitable for Replacing

7D1/2 - 2000W. 5-turn screw terminals
7D1/4 - 2000W. 5-turn tab terminals
7D1/5 - 2000W. 4-turn tab terminals

In most cases the combination terminal will not require modification but it is important that the servicing engineer should check earth clearances

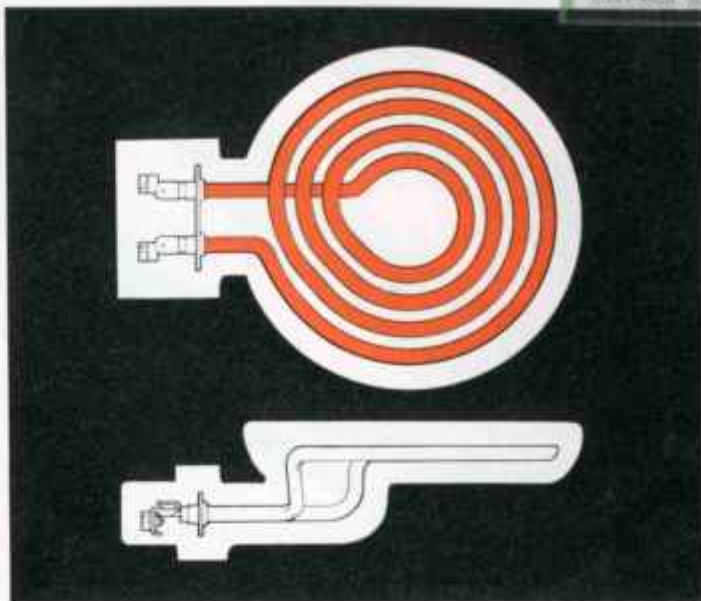

New Plate Code

6D1/245/4

Registered Design applied for

Type

1500W. 240V. 6" Dia. 4-turn
Single circuit plate with
combination tab and screw terminals

Suitable for Replacing

6D1/2 - 1650W. 4-turn screw terminals
6D1/4 - 1650W. 4-turn tab terminals
1500W. 4-turn tab terminals
6D1/5 - 1200W. 3-turn tab terminals

on installation and, if found necessary, remove the unused part of the terminal whilst supporting the element terminal post.

*For full range of plates see
Publication No. G.C.22*



BACKER ELECTRIC COMPANY LIMITED
ROTHERHAM, YORKSHIRE

Telephone: 0709-78181 Telex: 54161



BACKER
TWIN-
TERMINAL
BOILING
PLATES

Yet another move in Backer's policy of reducing stock ranges to the absolute minimum. These new Twin-Terminal Boiling Plates eliminate the need to stock both tab and screw-type terminal plates in the single circuit 7" and 6" diameter sizes.

Think how this will release your valuable storage space, reduce capital tied-up in stock and simplify record keeping and sales identification.

See over for full details.

Backer Twin-Terminal Boiling Plates

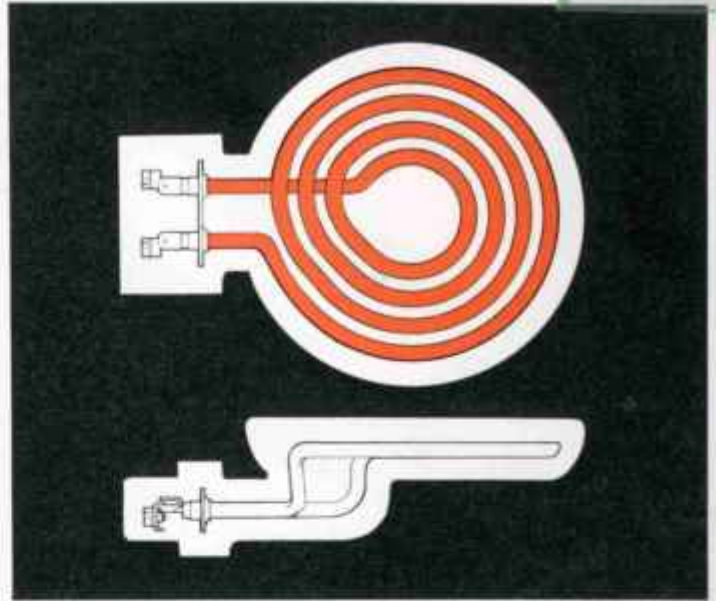
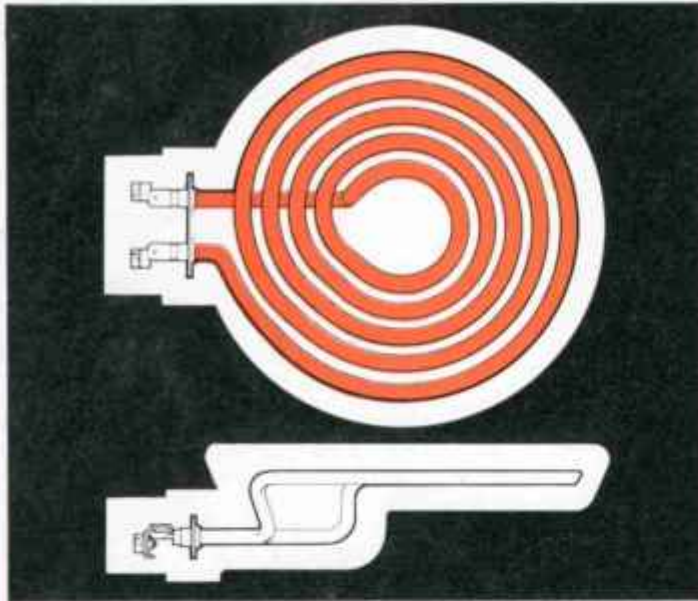

New Plate Code

7D1/245/5

Registered Design applied for

Type

2000W. 240V. 7" Dia. 5-turn
Single circuit plate with
combination tab and screw terminals

Suitable for Replacing

7D1/2 - 2000W. 5-turn screw terminals
7D1/4 - 2000W. 5-turn tab terminals
7D1/5 - 2000W. 4-turn tab terminals

New Plate Code

6D1/245/4

Registered Design applied for

Type

1500W. 240V. 6" Dia. 4-turn
Single circuit plate with
combination tab and screw terminals

Suitable for Replacing

6D1/2 - 1650W. 4-turn screw terminals
6D1/4 - 1650W. } 4-turn tab terminals
 1500W. }
6D1/5 - 1200W. 3-turn tab terminals

In most cases the combination terminal will not require modification but it is important that the servicing engineer should check earth clearances

on installation and, if found necessary, remove the unused part of the terminal whilst supporting the element terminal post.

*For full range of plates see
Publication No. G.C.22*



BACKER ELECTRIC COMPANY LIMITED
ROTHERHAM, YORKSHIRE

Telephone: 0709-78181 Telex: 54161

Domestic Immersion Heaters

full range of Standard heaters conforming fully to BS3456 Section A8



Backer immersion heaters are designed and made for use by those who want the best value for money. With element lengths from 11' to 36', a wide choice of stem and stemless type thermostats, with sheaths available in Incoloy for corrosive or hard water conditions, they provide the most effective, long-lasting, and attractive answer to domestic water heating.

Backer Electric Company Limited

Another winner from Backer

- Bright nickel plated for attractive appearance and resistance to corrosion
- Virtually unbreakable phenolic terminal box
- Pre-packed in attractive polythene display pack in cartons of ten with easily identified Backer house colours
- Special sheaths available for hard or corrosive waters

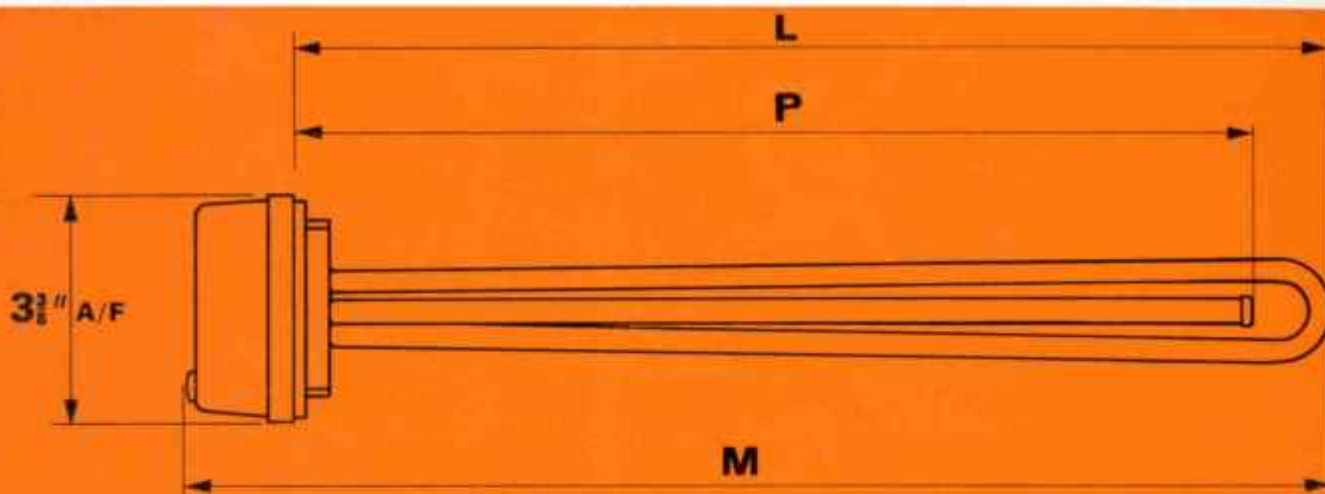

	No. Pack	Kilowatts	L	P	M	Thermostats
STANDARD	311	3	11	11	12 ^{5/8}	1, 2, 3
	*314	3	14	11	15 ^{5/8}	1, 2, 3
	318	3	18	11	19 ^{5/8}	1, 2, 3
	*323	3	23	18	24 ^{5/8}	1, 2, 3
	327	3	27	18	28 ^{5/8}	1, 2, 3
	*330	3	30	18	31 ^{5/8}	1, 2, 3
336	3	36	18	37 ^{5/8}	1, 2, 3	
SHORT STEM	311S	3	11	4 ^{3/4}	12 ^{5/8}	4
	318S	3	18	4 ^{3/4}	28 ^{5/8}	4
	327S	3	27	4 ^{3/4}	37 ^{5/8}	4
ANTI-CORROSIVE for use in Corrosive or Hard Water Areas	311C	3	11	11*	12 ^{5/8}	1, 2, 3
	327C	3	27	18*	28 ^{5/8}	1, 2, 3
	336C	3	36	18*	37 ^{5/8}	1, 2, 3
DUO IMMERSION HEATER	527	3 + 2	27			Complete with Two Thermostats See Leaflet G.C.32
WHITE METER WATER HEATING SYSTEM	600	3 + 3	11			Complete with Otter Thermostat L21 K83 and 1 Shot Relay See Leaflet G.C.31

* Made to order 3-4 weeks;
all others ex-stock.

Thermostats



1 MacLaren WH



2 Satchwell VK



3 Otter Singlestat

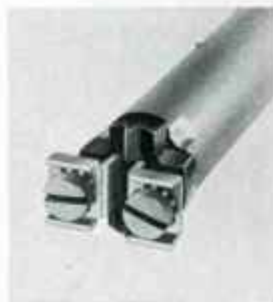

4 Sunvic TQB-AU

The Sunvic TQR, MacLaren MB, and Proscor P2 thermostats may be used in place of the first three listed and the MacLaren WE may be used instead of the last mentioned if desired.



BACKER DUO IMMERSION HEATER FOR CHEAPER HOT WATER



Most housewives are aware of the wastefulness of heating a full storage tank when only the top half is needed, and many, particularly those with other off-peak installations, would like to change to 'white meter' water heating without the cost or inconvenience of fitting a new twin side-entry tank. Now, both these problems can be overcome by replacing the existing immersion heater with the Backer Duo Twin-Element Unit available in Pack 527. The long 27" (2 kw) element heats the full tank depth when needed whilst the short 12" (3 kw) element heats only the top portion for normal use.

Design features include 18" and 11" thermostats for rapid recovery and an extra long inactive length on the 27" element which, with return bend, ensures uniform water temperature throughout the tank.

The advantages of the Backer System to the contractor are:

1. The Duo Unit fits the existing solder flange in the tank — eliminating the need to fit a second solder flange.
2. The Duo Unit allows you to offer the housewife a choice of fully-automatic 'white meter' operation, semi-automatic standard tariff operation, time switch control, or manual control.
3. There are many combinations of time/manual switching of the supply to these units to provide the most convenient and economical installation for the individual householder.
4. Only one 20 amp. supply cable is needed, even if the two heaters operate simultaneously.
5. You can depend on the Backer reputation for quality of design and components plus expert advice when needed — adding up to years of trouble-free, reliable service.



Shaped
heat



**"CAN I
HAVE
CHEAPER
HOT
WATER?"**

TELL HER ABOUT THE BACKER DUO IMMERSION HEATER



water boiler elements

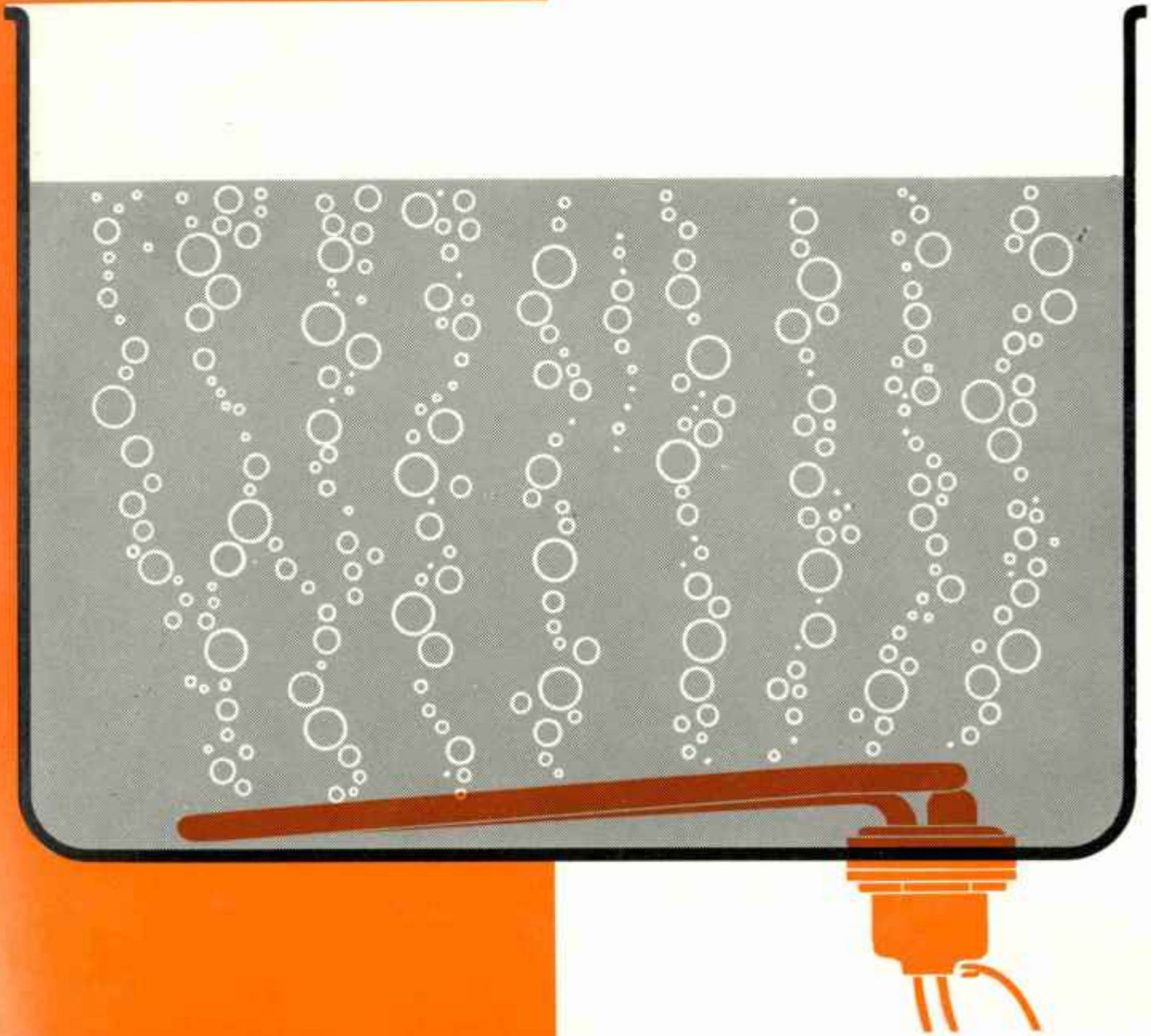

For any liquid, Backer immersion elements give *exactly* the heating required — exactly where you want it. In nickel plated copper, Backer elements are the ideal choice for water boilers, processing tanks, plating and pickling vats, sterilizers, steamers, steam-raising equipment, industrial kettles, oil lubrication and storage systems.

a full range of stock sizes

Backer internally mounted rectangular elements are available off the shelf in a range of sizes for side and bottom entry. To prevent overheating, elements are supplied with cut-outs pre-set at 300°F and can be used for boiling under slight pressure conditions.

All units are supplied with nickel plate finish, complete with locking ring, one neoprene and one graphited asbestos joint washer. AMP terminals are standard. Matching and sleeved leads are available as extras — please quote length required.

Technical service Backer engineers will lend assistance to determine the most suitable heating element for your application—most suitable from an engineering performance, installation cost, operating cost and space utilisation. To gain the full advantage of this design service contact Backer at the earliest design stage of your project.

ULTIMHEAT[®]
VIRTUAL MUSEUM

Special shapes, special sheath materials and special ratings are made to order.

Bottom entry

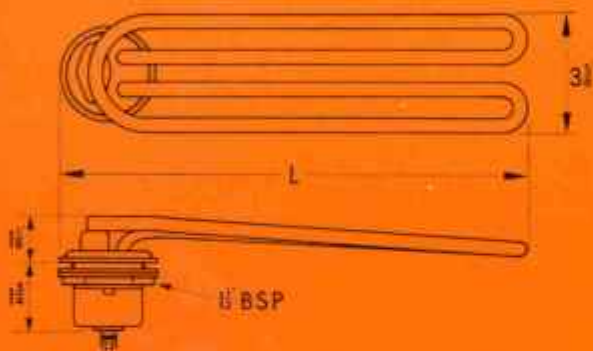

CODE

L
inches

Rating
kilowatts

7B7011

10

2kW; 240V

7B7012

11 1/2

2.5kW; 240V

7B7013

12 1/2

3kW; 240V

Side entry



7B8011

7

2kW; 240V

7B8012

10

2.5kW; 240V

7B8013

10

3kW; 240V



Shaped heat

Backer Electric Company Limited

Standard stock elements

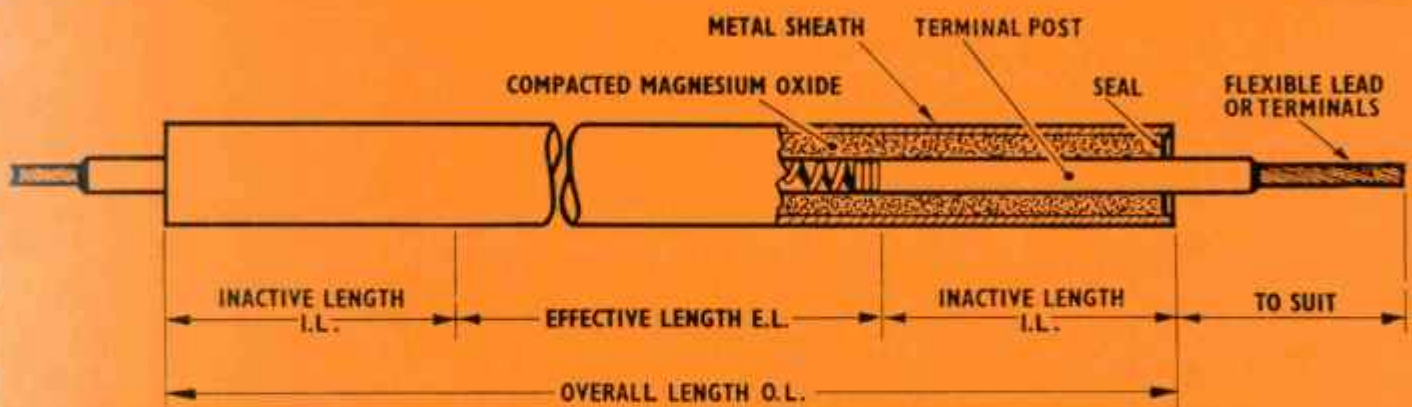

Wherever controlled heat is required up to 700° – in the laboratory or for prototype work – you can meet your needs effectively, quickly and economically by using Backer Standard stock elements. Made by the powder filling process, stock elements are immediately available in lengths and loadings given overleaf.

Illustration above shows detail construction of circular-section elements made by the powder filling process. The Backer tubular sheathed elements, 0.250" to 0.333" diameter, are relatively flexible and can be formed cold

around a bending post of minimum diameter listed under 'Minimum Bending I.D.' to any shape best suited for a particular installation.

Bends can be formed to within $\frac{1}{4}$ " of internal end of terminal posts, enabling even complicated shapes to be readily produced.

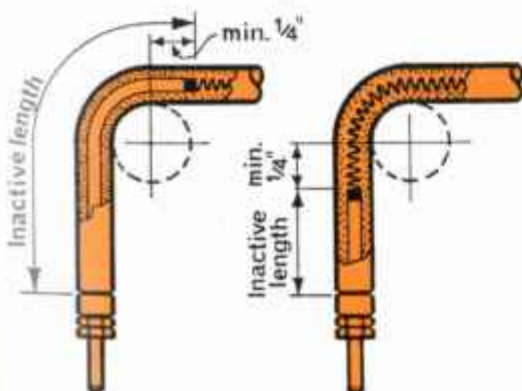

Element Diameter	Material	Min. Bending I.D.
0.250"	'Incoloy' & S.S.	$\frac{1}{2}$ "
0.281"	B.W.M.S.	$\frac{7}{8}$ "
0.3125"	Copper	$\frac{3}{16}$ "
0.333"	B.W.M.S.	$\frac{7}{8}$ "

B.W.M.S. = 'Bundyweld' mild steel.

S.S. = Stainless Steel.

Bends should commence 1" or more from the tube end and be designed to ensure that the coil end of the terminal post does not lie nearer than $\frac{1}{2}$ " to the commencement or completion of a radius.

The table below shows the diameter, length and sheath material of the standard elements available from stock. The rating and watts density are given for operation on

240V and the operating temperature assumes free air conditions.



Single Elements								
Element Stock Ref	Element Dia	Material	Overall Length	Effective Length	Minimum Bending I.D.	Loading at 240v	Watts Density per sq in.	Sheath Temp. in Free air at 240v
ZC1	.250" ±.003"	'INCOLOY'	115 $\frac{3}{4}$ " ^{+$\frac{3}{4}$"} -1 $\frac{1}{4}$ "	111 $\frac{1}{2}$ "	$\frac{1}{2}$ "	3130w	35.8w/□"	680°C
ZC2	.250" ±.003"	'INCOLOY'	104 $\frac{1}{2}$ " ±1"	99 $\frac{1}{2}$ "	$\frac{1}{2}$ "	2610w	33.4w/□"	655°C
ZC3	.250" ±.003"	'INCOLOY'	91 $\frac{1}{2}$ " ± $\frac{7}{8}$ "	80 $\frac{1}{2}$ "	$\frac{1}{2}$ "	2090w	33.1w/□"	650°C
ZC4	.250" ±.003"	'INCOLOY'	87 $\frac{3}{8}$ " ± $\frac{7}{8}$ "	81 $\frac{1}{8}$ "	$\frac{1}{2}$ "	1880w	29.5w/□"	630°C
ZC5	.250" ±.003"	'INCOLOY'	42" ± $\frac{1}{2}$ "	37 $\frac{1}{2}$ "	$\frac{1}{2}$ "	1150w	39.1w/□"	700°C
ZC6	.250" ±.003"	STAINLESS STEEL	41 $\frac{3}{4}$ " ± $\frac{3}{8}$ "	38 $\frac{1}{2}$ "	$\frac{1}{2}$ "	545w	18.1w/□"	520°C
ZC7	.333" ±.003"	B.W.M.S.	64" ± $\frac{5}{8}$ "	60 $\frac{3}{4}$ "	$\frac{7}{8}$ "	1250w	19.7w/□"	530°C
ZC8	.281" ±.003"	B.W.M.S.	50 $\frac{3}{4}$ " ± $\frac{1}{2}$ "	47 $\frac{1}{4}$ "	$\frac{7}{8}$ "	890w	21.4w/□"	560°C
ZC9	.250" ±.003"	'INCOLOY'	90" ^{+$\frac{3}{4}$"} -1"	86 $\frac{1}{2}$ "	$\frac{1}{2}$ "	2350w	34.6w/□"	670°C
ZC10	.3125" ±.003"	COPPER	44 $\frac{1}{2}$ " ±1"	39"	$\frac{9}{16}$ "	2000w	52.3w/□"	780°C

If the elements tabled above are operating at too high a temperature or watts density for your application, these may be reduced to enable them to meet your specification by connecting in series. The rating, temperature, and watts density figures are given in the table on the right for the standard elements when connected two in series on 240V.

2 Elements in Series

Element Stock Ref.	Total Loading of 2 Elts. in Series at 240V	W.D.	Sheath Temp. in Free Air at 240V
ZC1	1565w	8.95w/□"	400°C
ZC2	1305w	8.35w/□"	385°C
ZC3	1045w	8.3w/□"	380°C
ZC4	940w	7.4w/□"	350°C
ZC5	575w	9.8w/□"	420°C
ZC6	272.5w	4.5w/□"	275°C
ZC7	625w	4.9w/□"	300°C
ZC8	445w	5.35w/□"	320°C
ZC9	1175w	8.65w/□"	390°C
ZC10	1000w	13.07w/□"	470°C

You can select from 4 standard terminations for your Backer stock elements – flexible rope, 2BA screwthread, 3BA flag, and 'AMP' Faston. All these terminals are mounted on insulators and the sketches for each one below show the layout and reference numbers to be quoted on your order.
e.g. ZC3/1619 would describe a 2090w 240V elt with overall length of 91 $\frac{1}{2}$ " fitted with 2BA screw threaded terminals.

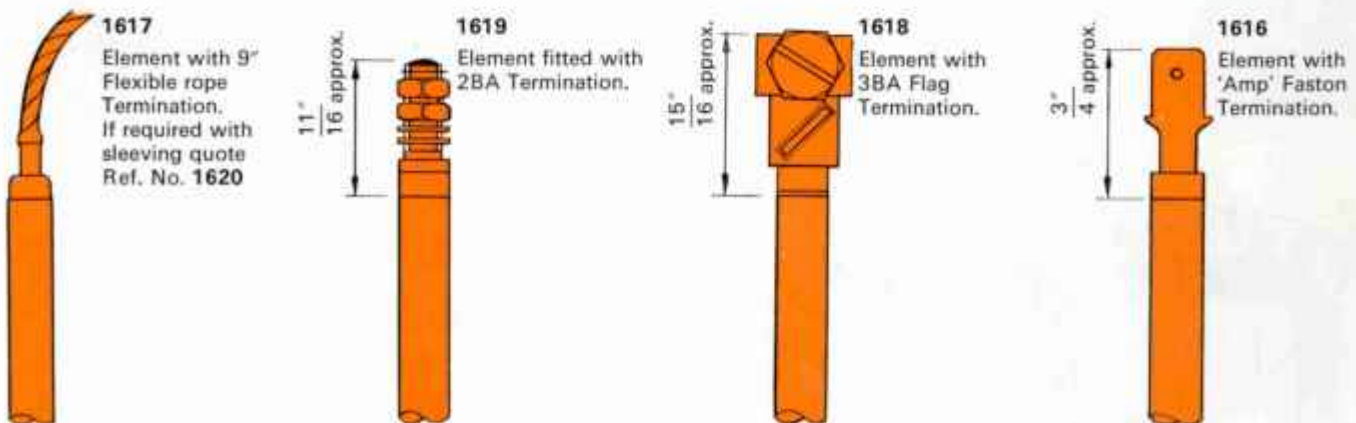

BACKER ELECTRIC COMPANY LIMITED

Europe's leading heating element specialists

Rotherham Yorkshire Telephone: Rotherham 78181 Telex: 54161

Cartridge Heaters

FOR HEATING SOLIDS UP TO 800°C

in the foundry

coreplate heating, moulding machine hotplates, sand drying equipment, core blowing machines, shell moulding equipment.

**in process heating
in plastic**

disc brakes, impregnated tapes, razor blades.

nozzle and barrel heating on extrusion presses, heated dies.

**in the laboratory
in drying**

flask heating hotplates.

tobacco curing hotplates, paper and textile drying components.

**in refrigeration
in general**

de-icing commercial refrigerators.

branding irons, embossing dies, bottle labelling machines.

Rated up to 100 Watts/active inch inserted, these Inconel sheathed cartridge elements are suitable for operation up to 800°C.

Designed for 9/16" diameter bores, in lengths from 6" to 4' 6".



**Backer
Electric Company
Limited**

the most convenient **heat source** available

Requiring only a 9/16" drilled hole in the body to be heated, the Backer cartridge heater is the most effective heat form available. To make up your own industrial hotplates or platens simply obtain 1" thick cast iron, Stainless Steel or mild steel plate and drill lateral or longitudinal holes for the heaters. Cartridge heaters for hole sizes from 3/8" to 2" can be supplied if required.

In die heating, where the run is continuous, the die base should be thick enough to allow for heater positioning—it is considerably more economical to employ built-in heat than to bolt down a die on to a heater plate. The latter method can be used for short runs allowing several designs of die to be clamped to one plate.

The inserted inactive length of heater can be made to order, allowing the heater to pass through lagging and heated body without overheating. The rating of heaters can be made to suit customers' requirements but a stock range is available at 240 volts (see table).

N.B.—It is important to note that these heaters would overheat if permitted to operate in air and must only be used completely surrounded by metal.

TYPICAL APPLICATIONS

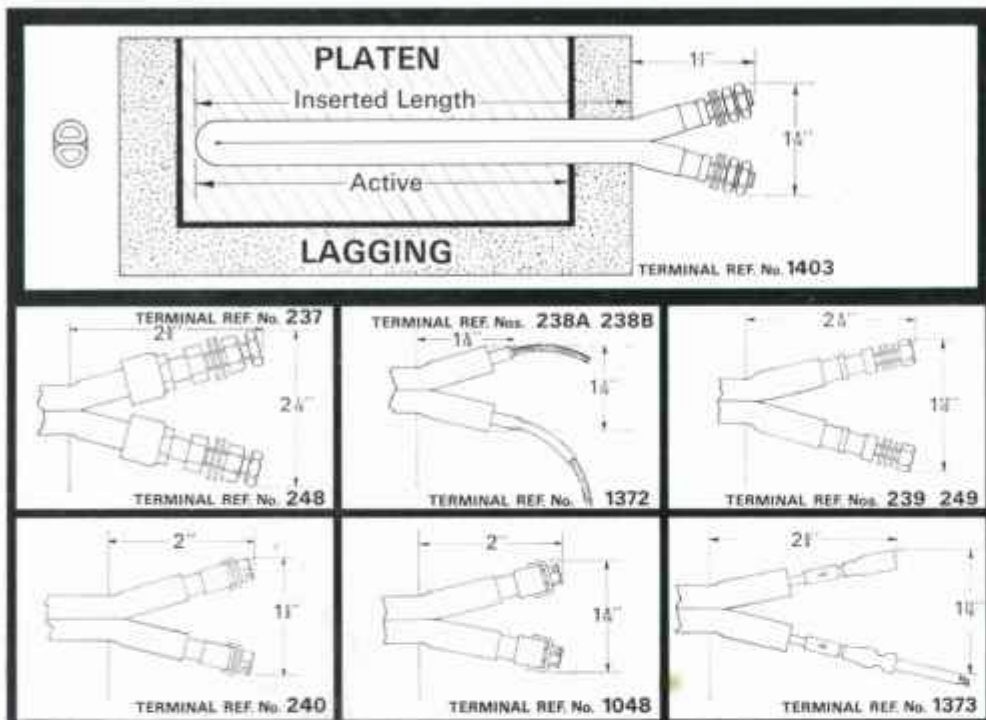

Specialists in the production of high precision forgings, Monk Bridge Iron & Steel Company of Leeds, employ special Backer Cartridge Element Assemblies built into each half of the tool set of this 1000-ton press used in the manufacture of turbine and compressor blades. The six 2250 watt elements in both top and bottom tool sets play a vital role in ensuring accuracy during the forging process of metals such as: Stainless Steel, Nimonic and Titanium Alloys.



Illustrated here is a circular saw blade tempering and flattening gough working at 500°C in the works of Messrs. R. H. Walker & Son Limited of Sheffield. The even heat required on the working surfaces is obtained by fitting Cartridge Elements of varying length like spokes of a wheel. The flexible terminations are connected to bus bars within the lagging box.



Two heater plates, each 20 kW rating, are built into each side of this mould and core blowing machine by Polygram Casting Co. Ltd. One operator is able to work two manipulators in sequence, one being blown while the shell moulds or cores at the second station are curing.

STOCK ELEMENTS

Heater Ref No. when ordering	Rating	Inserted Length	Active Length
ZA 1	600W	6 1/2"	6"
ZA 2	800W	8 1/2"	8"
ZA 3	1000W	10 1/2"	10"
ZA 4	1100W	11 1/2"	11"
ZA 5	1300W	13 1/2"	13"
ZA 6	1500W	15 1/2"	15"
ZA 7	1700W	17 1/2"	17"
ZA 8	2000W	20 1/2"	20"
ZA 9	2300W	23 1/2"	23"
ZA 10	2900W	29 1/2"	29"

For example:
ZA5 / 239 is a 1300W Element with a 3 BA brass pillar terminal.

STOCK TERMINALS

Terminal Ref. No.	Material	Terminal Type	Max. term. Operating Temperature
237	Brass	OBA Post	350°C
238A	Nickel Chrome	Flexible*	500°C
238B	Nickel	Flexible*	400°C
239	Brass	3BA Post	350°C
240	Stainless Steel	Cleat	400°C
248	Stainless Steel	OBA Post	600°C
249	Stainless Steel	3BA Post	600°C
1048	Brass	Cleat	350°C
1372	Sleeved/Nickel	Flexible*	200°C
1373	Nickel/glass sleeved	Clinched Flexible*	200°C
1403	Stainless Steel	OBA Post	650°C

* Quote length required

In ambient temperatures above 300°C it is advisable to use stainless Steel terminals.



Shaped heat

G.C.28



Bolt Heaters

FOR EXPANSION TIGHTENING AND EXPANSION SLACKENING OF BOLTS IN
STEAM TURBINES
HYDRAULIC PRESSES
AND OTHER PLANT



Photographs by courtesy of The English Electric Co. Ltd.

**Backer
Electric Company
Limited**

CONSTRUCTION

Backer Bolt Heaters are manufactured to suit the bolt concerned and consist of a D-section Inconel element fitted to a terminal box and handle. The smaller/bore heaters usually have an additional outer sheath of aluminium brass.

The active length stretches from the tip of the heater to a point some distance from the stop ring or head plate, determined by thickness of nuts and/or internal threads of the bolt. Diameters can be made as required, but they have to a great extent been standardised and the bores we prefer to match are listed in the adjoining table.

SUPPLY CONNECTIONS

All heaters are fitted male inlet plug for quick connection to the mains or transformer leads for which corresponding female outlet sockets are available.

Current limitations on standard plugs are 25 amps and 50 amps. Other types of connection can be offered for higher current.

RATINGS

As it is imperative to heat the bolt as quickly as possible before the frame also expands, in order to achieve the maximum differential expansion, the elements are at approximately 50 W per square inch, or 50 W per square inch of bore wall whichever is the lesser. At this load there is considerable danger of burning out if the heater is operated in free air, and the sheaths are designed to be an extremely good push-fit; not more than 1/64" clearance for single element heaters up to 7/8" bore and 1/32" clearance on 2 or 3 element heaters over 1" bore. This also ensures efficient conduction from heater to bolt.

For applications where 110v low-voltage regulations concerning portable equipment in power stations apply, the current-bearing capacity of the terminals imposes a limit of 5250 W on the larger heaters and 2500 W on the smaller ones. Otherwise, voltages up to 440 can be catered for, and in that case the maximum rating of a larger heater is approximately 10 kW.

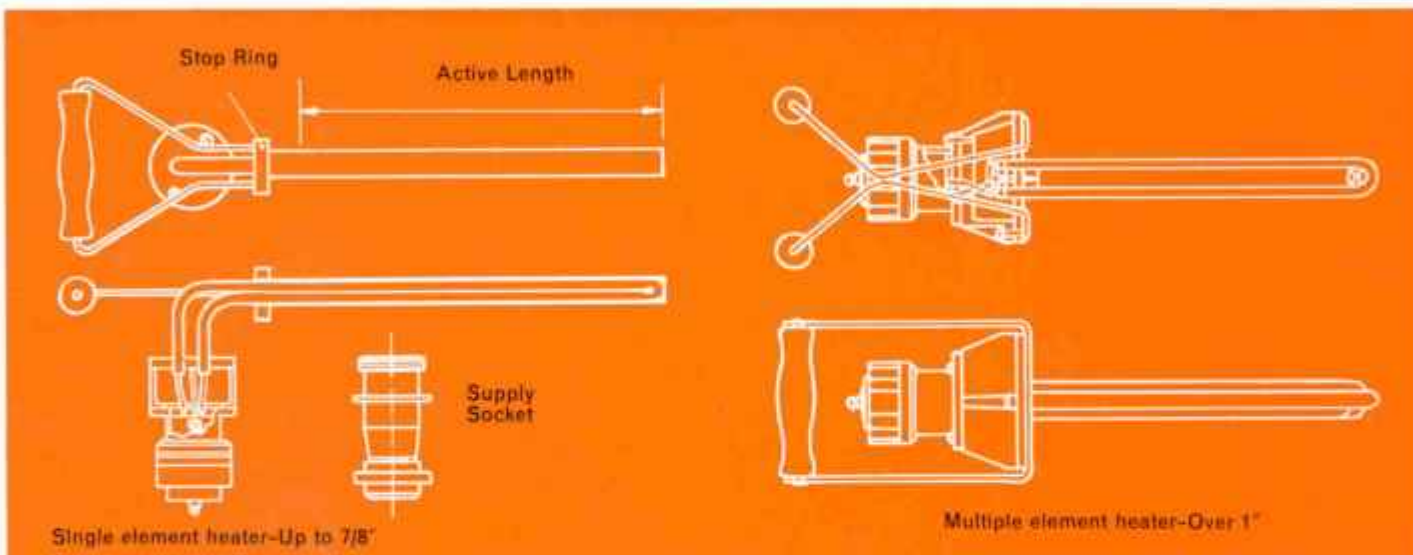

PREFERRED BORE SIZES	MAX. WATTS PER 1" ACTIVE	MAX. INSERTED LENGTH	MAXIMUM LOAD		
			110/115	200/250	380/440
15/32"	100	51 3/8"	2500W	4500W	6500W
5/8"	120	51 3/8"	2500	4500	6500
41/64"	120	51 3/8"	2500	4500	6500
11/16"	120	51 3/8"	2500	4500	6500
3/4"	140	51 3/8"	2500	4500	6500
49/64"	140	51 3/8"	2500	4500	6500
7/8"	140	51 3/8"	2500	4500	6500
1-1/16"	200	52 1/2"	5000	8000	10000
1-1/8"	212	52 1/2"	5000	8000	10000
1-1/4"	236	55"	6750	10000	10000

Design of special high loaded heaters can be undertaken.



Shaped
heat

OPERATION

In many applications two opposite bolts require to be tightened in pairs, and so heaters are normally supplied in sets of two. The important steps in tightening procedure are as follows, and slackening procedure takes the same pattern.

1. Tighten the bolts cold.
2. Remove plug screws and make sure that the holes are clear and clean.
3. Insert heaters as far as they will go, i.e., up to stop ring or head plate.
4. Switch current on.
5. Tighten nuts as soon as expansion allows enough take-up.
6. Switch off, but do not withdraw for 5 or 10 minutes, so that the heater emerges into free air at a safe temperature.

Please send the following details with any Enquiry or Order:

- 1 Fully dimensioned drawing of bolts or studs and their associated nuts.
- 2 Details of electricity supply.
- 3 Expansion requirements.



SHAPED HEAT FOR INDUSTRY

**BACKER ELECTRIC COMPANY LIMITED.
ROTHERHAM, YORKSHIRE,
Telephone : Rotherham 78181, Telex : 54161**

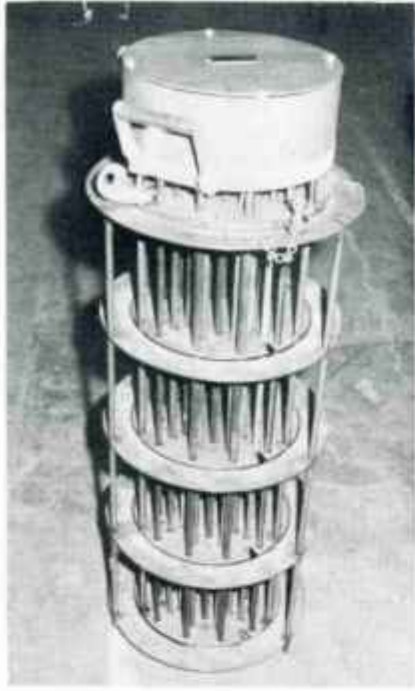

30 kW 415 V BORE HEATING UNIT

Comprising 21 1340 W 240 V elements. The bore heater is placed in the bore of an extrusion press container to pre-heat the container before extrusion commences. Once working temperature is attained, the heater is removed and the billet placed in the container.



210 kW TEST RIG

The photograph shows an experimental test rig which was used for testing the heat transfer properties of a new material which is used as heat insulation material on boilers and pipes in power stations. Our task was to simulate working conditions, this was done by covering the test rig with 70 3 kW elements formed to suit the rig.

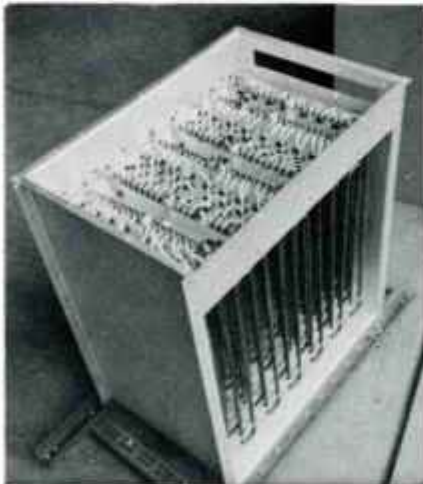

50 kW 415 V AIR DUCT HEATER

A 50 kW 415 V Air Duct Heater comprising 51 980 W 415 V elements, duct size 24" x 24". We do not manufacture a standard range but produce units to customers' specific requirements.

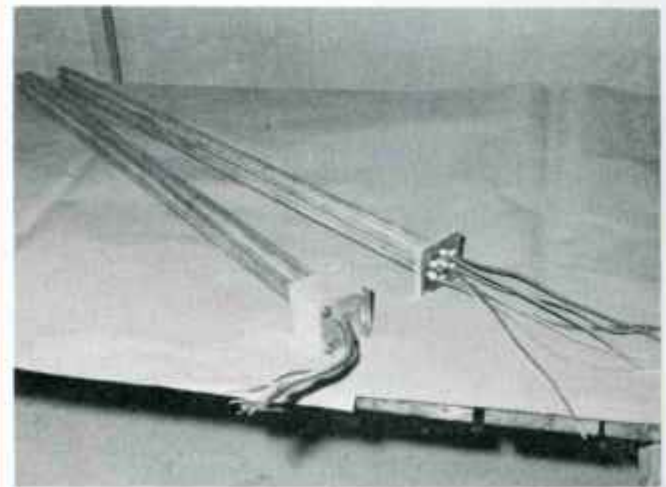

2" BORE CARTRIDGE HEATING UNITS

13.5 kW and 10 kW 2" bore cartridge heaters manufactured to heat and maintain press tool dies at elevated temperatures in the production of turbine blades. We also produce a range of $\frac{1}{8}$ " bore cartridge heaters and bolt heaters for sizes ranging from $\frac{5}{16}$ " to 1 $\frac{1}{2}$ " bore.

24 kW 110 V HOPPER HEATER

24 kW 110 V Hopper heating assembly, comprising 12 2 kW elements. This arrangement shows elements clamped to the underside of a hopper to ensure the contents are dry and free-running. This approach has been adopted on grain, sand and chemical containers.

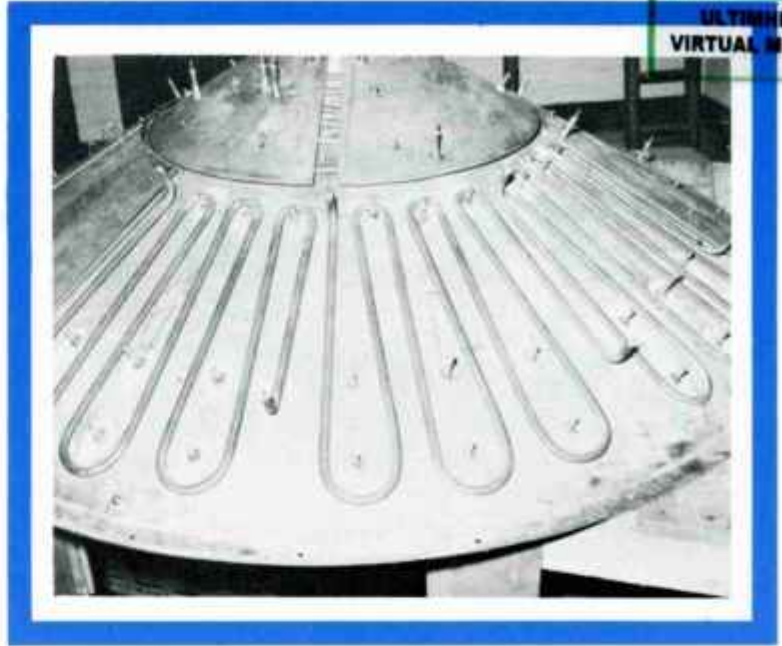

EXTRUSION PRESS CONTAINER HEATING

The two illustrations F and G show the two methods of heating on extrusion press containers. The container holds a billet which must be heated to extruding temperature, the two approaches adopted are :

1. Fig. F. Periphery heating shows radiant elements placed around the container.

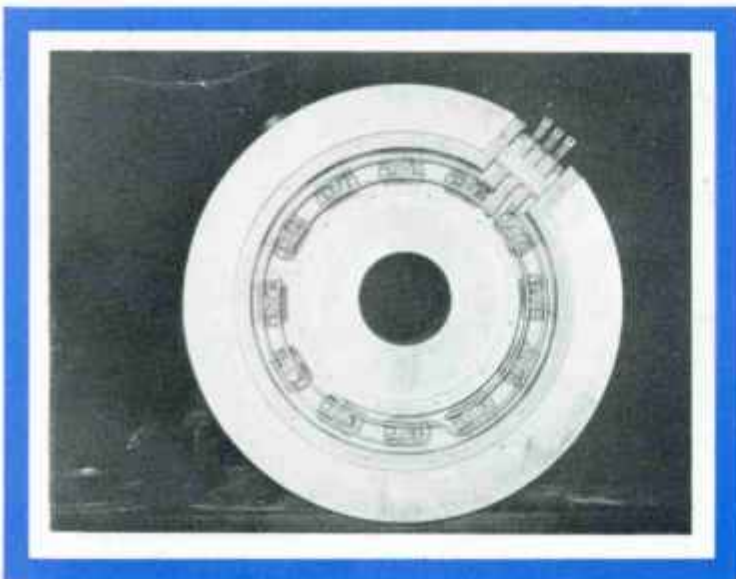

2. Fig. G. Shows cartridge elements which fit within the container itself. This method has been employed on carbon, aluminium and copper extrusion presses.



ULTIMHEAT[®]
VIRTUAL MUSEUM

8 kW ELECTRICALLY HEATED CHEMICAL TANK

8 kW 440 V 3-phase electrically heated chemical tank. The customer requested we should provide the tank heating arrangement, control equipment, etc. The tank contains sodium silicate, which is used to coat sand castings to give a better surface finish. We are able to produce special industrial immersion heaters.



400 W CAST ALUMINIUM HOTPLATE

400 W 240 V Aluminium cast hotplate. The design illustrates a die cast aluminium hotplate in which the element is cast. This component was manufactured for one of the largest manufacturers of laboratory equipment in the United Kingdom. The groove and recess take the temperature control probe and a rotating magnet. Elements have been cast in aluminium, phosphor bronze and cast iron.

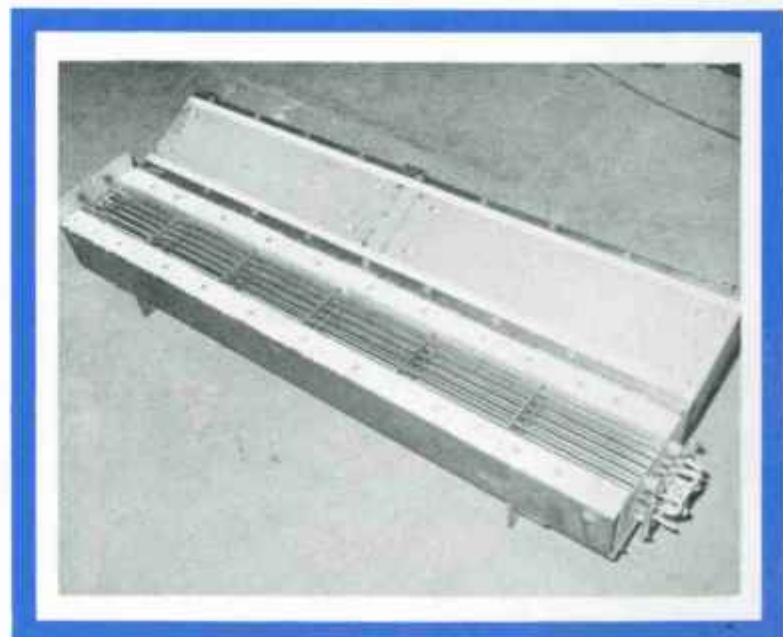

3.36 kW CABLE SINTERING OVENS

These units were produced for British cable manufacturers and are used to heat shrink PVC outer coating on cable. The process is continuous and the cable passes through the centre of the oven.

Backer Galvanising Zinc Bath Heating Unit



Non-electric Method

Direct heat by solid fuel. No accurate temperature control. *Stoking and damping* necessary. Ambient temperature uncomfortable for operatives. Alternative gas or oil-fired installations are expensive.

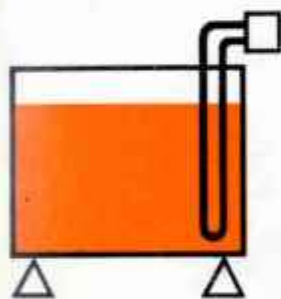

Short-term Method

Electric heating by immersed elements. Corrosion causes early element failure – high maintenance costs.

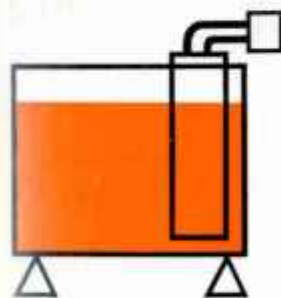

Mid-term Method

Electric heating by element encased in cast iron sheath. Valuable galvanising capacity lost. Heating unit replacement costs are very high.

Backer Long-term System

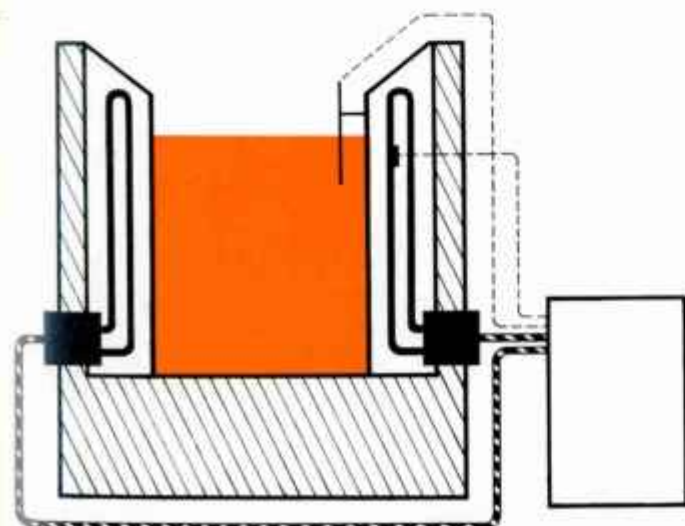

Corrosion of Heating Elements Eliminated

Accurate Temperature Control $\pm 3^{\circ}\text{C}$

Insulated Against Heat Loss
'Hot-spot' Oxidation Minimised

The Backer *Galvanising Zinc Bath Heating Unit* consists of a series of Incoloy sheathed elements spaced at equal intervals around the *outside* of the bath walls but within a highly efficient insulation shield which considerably reduces heat losses – a top cover being used to conserve heat between production runs.

Delta/star switching allows full element capacity to be used during the warm-up period and part-load operation to maintain the working temperature of 450°C . Accurate temperature control to within $\pm 3^{\circ}\text{C}$ is achieved by two thermocouples. One, immersed in the bath, controls zinc temperature and changeover from full to part load. The other is attached to the element sheaths to give high temperature warning.

Since the elements do not come into contact with the corrosive molten metal and since the even temperature created throughout the bath minimises 'hot-spot' oxidation of its walls, a long operational life with low maintenance costs is assured. The use of low thermal mass insulation, which cools quickly, gives rapid access when maintenance is required.

Initial installation costs are relatively low in comparison with the more complicated gas and oil-fired equipment.

If you wish to convert your *galvanising operation* to *electric Heating* send details of bath dimensions and throughput to us today. You will receive a design recommendation and quotation which includes installation and commissioning costs.

For further information write to:



BACKER ELECTRIC COMPANY LIMITED
ROTHERHAM, YORKSHIRE, ENGLAND
Telephone 0-709-78181 Telex 54161



Backer

BACKER ELEMENTS